

BREAKING

ANNUAL REPORT 2021

NEW GROUNDS



Breaking the barriers for breakthrough in finance

At Shinhan Financial Group, we are constantly developing ourselves further in order to seize new opportunities – and yet always remaining true to our principles. In 2021, despite the challenges posed by the prolonged COVID-19 pandemic, we achieved a record-breaking performance, while also continuing our ESG journey driven by our mission of “Building a Better World through Finance.” And now we are well positioned to take new challenges with “Breakthrough” as our strategic keyword for the years ahead.

CONTENTS

1 MANAGEMENT REPORT

- 04 Key Performance Indicators
- 05 Stock Information
- 06 CEO Reflections
- 14 F.R.E.S.H 2020s
 - Fundamentals
 - Resilience
 - Ecosystem
 - Sustainability
 - Human-talent

2 REVIEW OF OPERATIONS

- 62 Business Report
- 74 Corporate Governance Report

3 APPENDIX

- 79 Board of Directors
- 82 Management
- 86 Organization
- 87 Business Portfolio
- 88 Global Network

2021 AUDITED FINANCIAL STATEMENTS

- 01 Independent Auditor's Report
- 05 Consolidated Statements of Financial Position
- 07 Consolidated Statements of Comprehensive Income
- 09 Consolidated Statements of Changes in Equity
- 11 Consolidated Statements of Cash Flows
- 14 Notes to the Consolidated Financial Statements

This report has been published as an interactive PDF, allowing readers to move quickly and easily to pages in the report, and including shortcuts to related web pages.



Bookmark



Table of Content



Previous Page



Related Webpage



File Download

KEY PERFORMANCE INDICATORS

KEY FINANCIAL HIGHLIGHTS

		2021	2020	2019
Selected Income Statement Data (As of for the year ended December 31, KRW billion)	Operating Income before Expenses	12,691.6	11,532.9	11,131.7
	Interest Income	9,053.5	8,155.1	8,001.0
	Non-interest Income	3,638.1	3,377.8	3,130.7
	G&A Expenses	5,743.1	5,212.5	5,134.7
	Operating Income	6,948.5	6,320.4	5,997.0
	Non-operating Income	-368.4	-175.9	-134.7
	Pre-provision Income	6,580.0	6,144.5	5,862.3
	Provision for Credit Losses	996.4	1,390.6	950.8
	Earnings before Income Tax	5,583.7	4,753.9	4,911.5
	Income Tax	1,471.0	1,255.8	1,269.1
	Consolidated Net Income ¹⁾	4,019.3	3,414.6	3,403.5
Selected Balance Sheet Data (Period-end, KRW trillion)	Loans in KRW (Shinhan Bank)	271.1	248.8	225.0
	Deposits in KRW (Shinhan Bank)	281.9	260.2	233.0
	Group Assets (Consolidated)	648.2	605.2	552.4
Selected Ratios (%)	Cost to Income Ratio	45.3%	45.2%	46.1%
	Credit Cost Ratio	0.27%	0.41%	0.31%
	(Credit Cost Ratio excluding one-offs ²⁾)	0.22%	0.29%	0.31%
	NPL Ratio	0.39%	0.49%	0.53%
	NPL Coverage Ratio	195%	168%	151%
	ROE	9.17%	8.43%	9.41%
	ROA	0.66%	0.60%	0.70%
	CET1 Ratio (Group) ³⁾	13.0%	12.9%	11.1%
Market Data	Closing Share Price (KRW)	36,800	32,050	43,350
	Market Capitalization (KRW trillion)	19.0	16.6	20.6

¹⁾ Net income in controlling interest

²⁾ One-offs: COVID19-related provisioning (KRW 187.9 billion for FY 2021; and, KRW 394.4 billion for FY 2020)

³⁾ When not reflecting the early adoption of the revised Basel III credit risk framework, CET1 is 11.8% for FY 2021

Financial Statements



4Q 2021 Business Results



GROUP NET INCOME

(KRW billion)

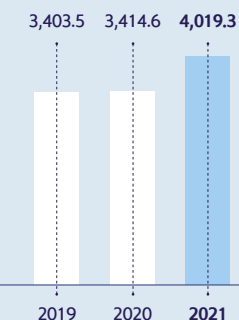

GROUP ASSETS

(KRW trillion)

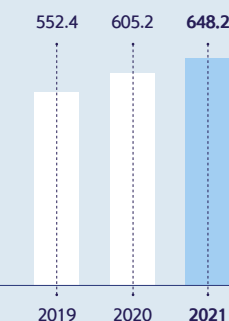

CUSTOMERS

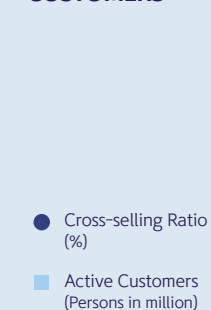

● Cross-selling Ratio (%)
■ Active Customers (Persons in million)

STOCK INFORMATION

MAJOR SHAREHOLDERS¹⁾

Name of Shareholder	Number of Shares Owned	Ownership
National Pension Service	45,340,437	8.78%
BlackRock Fund Advisors ²⁾	29,063,012	5.63%
SFG Employee Stock Ownership Association	25,464,625	4.93%
Centennial Investment Limited	20,440,000	3.96%
BNP Paribas SA	18,690,310	3.62%
Supreme, L.P.	18,690,000	3.62%
Citibank, N.A. (ADR Dept.)	15,728,396	3.04%
Norges Bank	10,436,161	2.02%
The Government of Singapore	9,477,462	1.83%
Vanguard Total International Stock Index	6,398,267	1.24%
Peoples Bank of China	5,522,909	1.07%
Others	340,410,987	65.89%
Total	516,599,554	100.00%

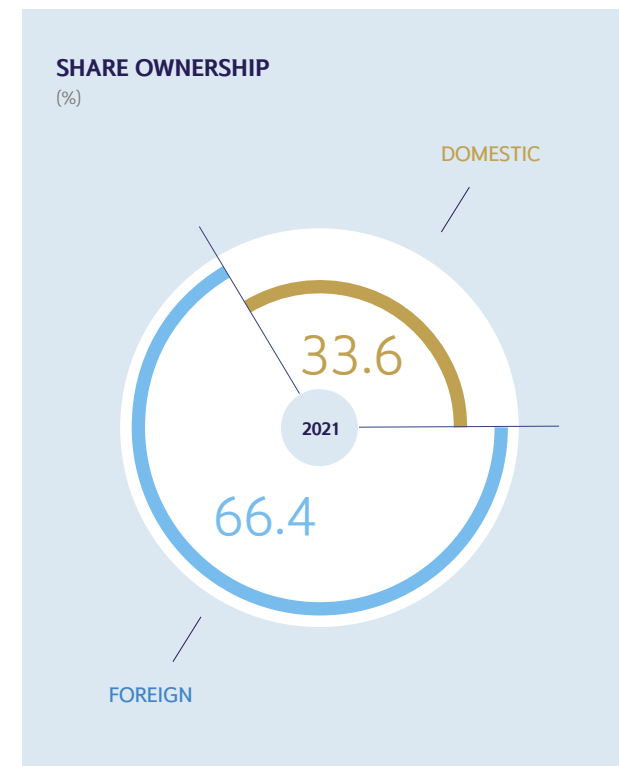

STOCK PERFORMANCE

(Unit: KRW)

	2021	2020	2019
Market Capitalization (Year End)	19.0 trillion	16.6 trillion	20.6 trillion
Share Price			
Year End	36,800	32,050	43,350
High	43,000	42,750	48,000
Low	30,650	22,200	38,350
Weighting in the KOSPI (% , Year End)	0.9%	0.8%	1.4%
Average Daily Trading Volume (Shares)	1.8 million	2.4 million	1.0 million
Dividend Per Share (Common Stock)	1,960	1,500	1,850
Total Dividend Paid (Common Stock)	1,047 billion	804 billion	884 billion
Dividend Payout Ratio (Common Stock)	25.2%	22.7%	25.0%

TYPE OF STOCK

Type of Stock	No. of Shares
Common Stock	516,599,554
Convertible Preferred Stock ⁴⁾	17,482,000

¹⁾ Holding ownership of more than 1% in common stocks as of December 31, 2021

²⁾ Based on the large equity ownership disclosure by BlackRock Fund Advisors with the Financial Supervisor Service on Sep. 27, 2018

³⁾ The Number of treasury shares held by Shinhan Financial Group as of December 31, 2021 is 6,352 common shares

⁴⁾ All of the 17,482,000 convertible preferred shares other than the above common shares are held by Mercury 1st LLC.

CEO REFLECTIONS



2021, which was dominated by the prolonged COVID-19 pandemic, was a challenging year for everyone. It has further highlighted the importance of recognizing the value of empathy and coexistence. Conscious of such social expectations we, Shinhan Financial Group made considerable efforts to ensure sustainable growth of our clients and communities. As a result, we were able to deliver outstanding results by “solidifying our business fundamentals” and undergoing “agile transformation”.

Cho Yong-byoung
Chief Executive Officer, Shinhan Financial Group

Dear shareholders,

In 2021, Shinhan Financial Group achieved its best performance ever since its establishment thanks to the united efforts of all our employees despite the many headwinds. We made improvements not only in the magnitude of our earnings growth, but also in the quality of the performance as well as the business fundamentals. Non-interest income grew as our IB, trust, foreign exchange and leasing businesses delivered strong returns, while interest income also increased thanks to effective margin management. On the back of these strong fundamentals, we pushed up our ability to generate ordinary income to the next level. In addition, we solidified our business portfolio and further expanded our income base by merging the Group subsidiaries and establishing new businesses.

We also have been nimble in our digital innovations to stay ahead of the curve and to compete more efficiently in our digital future. We enhanced customer convenience by innovating customer contact points, both online and offline. As a result of our efforts to provide the best possible customer experience, the figure for monthly active users (MAU) of Shinhan SOL, our market-leading banking platform, achieved the highest rate of increase in the Korean banking industry. We also built upon our traditional strength in finance by adding a number of business alliances and new non-financial businesses to creating new customer value. Moreover, we put substantial resources into developing innovative startups and expanding our digital investments.

We are fully committed to the responsibilities demanded of corporates by society. We have therefore rapidly forged ahead with the execution of our ESG strategy by setting out a detailed roadmap for ESG management and establishing an internal ESG driving system. In addition, we have focused on enhancing our ability to measure and manage environmental risks, while also facilitating the low-carbon transition of our corporate clients. At the same time, we have offered direct help to people in need, and continued to foster startups and create jobs.

In 2021, we grew in partnership with our customers, colleagues, and our society. This helped us to achieve the resolutions we made at the beginning of the year with a focus on the key words “Solid Fundamentals, Agile Transformation”. These successes were made possible by the unwavering encouragement and support from all of our customers, shareholders and other stakeholders, for which I thank you most sincerely.

In the next few pages, I'd like to discuss our business, digital and ESG highlights in more detail.



In 2022, Shinhan begins a new challenge, with “Breakthrough” as our strategic keyword for the year ahead. We will take the “right”, “nimble”, and “different” steps to build a “more friendly, more secure, more creative finance” as we strive towards our ultimate goal of achieving “Excellence”.

Record-breaking year

Achieved a record-high net income

2021 saw growing volatility in the Korean economy and in global financial markets due to a tenacious lingering of the pandemic and rising inflationary pressures. Even amidst these increased uncertainties, Shinhan achieved a record-high performance in net income on the back of its balanced business portfolio.

Against the backdrop of strong market liquidity and a thriving domestic real estate market, the Group subsidiaries in the capital market business broke their performance records in the first half of 2021. Then, in the second half of the year, as the interest rates normalized, banking subsidiaries achieved strong interest income growth. The year-round exceptional performance and balanced growth of the banking and non-banking sectors came as a result of our consistent strengthening of sales capabilities, targeted M&As, and establishment of new subsidiaries.

Significant changes were made to the Group portfolio in 2021. In January, Neoplux, a venture capital company acquired in September 2020, changed its name to Shinhan Venture Investment. It is now actively investing in innovative companies of the future, and strengthening its position in the Korean venture capital market. Also in January, Shinhan Asset Management became a wholly-owned subsidiary of the holding company, marking an end to the 18-year joint venture management system with BNP Paribas. In addition, the company merged with Shinhan Alternative Investment Management, positioning itself as a major comprehensive asset management company. Shinhan Life Insurance, newly launched by the merger between Shinhan Life Insurance and OrangeLife Insurance last July, rose to fourth place in the industry, and has expanded its dominance in the general agency (GA) market by establishing a new sales subsidiary, Shinhan Financial Plus.

Despite considerable external uncertainties that dominated markets in 2021, Shinhan Financial Group maintained its growth pace and strived to enhance shareholder value. We will continue to generate stable revenues through the efficient allocation of our capital, and will increase shareholder value by developing engines for future growth.

STRONGER BUSINESS PORTFOLIO

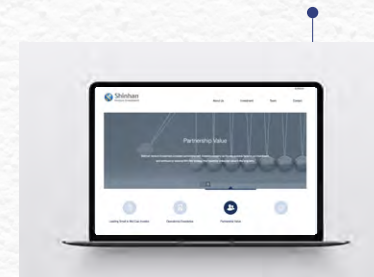

JANUARY

Shinhan Venture Investment, renamed from Neoplux

Shinhan Asset Management, became a wholly-owned subsidiary of Shinhan Financial Group

JULY

Shinhan Life Insurance, launched through the merger between Shinhan Life and OrangeLife



Group Net Income & Dividend Payout Ratio

- Dividend Payout Ratio
(Based on common stocks)
- Group Net Income
(Unit: KRW billion)

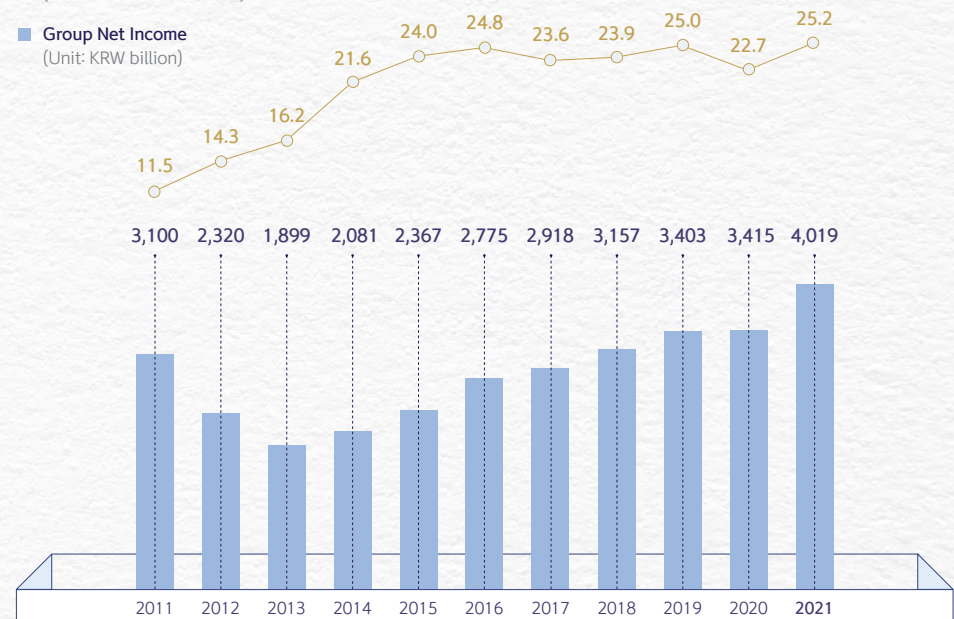

Ground-breaking innovation

Expanding and improving customer contact points

Digital natives, including Millennials and Generation Z, are becoming a vital consumer group, while the emergence of Internet banks and financial companies affiliated with big tech companies is resulting in sharp changes in trends in finance. Shinhan is responding rapidly to these challenges by offering new customer experiences. In partnership with the Korea Baseball

Organization (KBO), Shinhan Bank has created the “Shinhan SOL Baseball Park”, a metaverse baseball field, and also hosted an online fan meeting.

Shinhan Card unveiled Shinhan pLay, which added non-financial services to its existing payment services. Shinhan’s flagship financial platforms are continuing to add both financial and non-financial content, which has resulted in more frequent and longer visits from our customers. Consequently, the MAUs for Shinhan SOL and Shinhan pLay grew at the fastest speed within the industry domestically, and now both apps have more than 8.5 million monthly active users.

Shinhan Bank and Shinhan Card obtained a MyData business license in 2021, and launched the business in full this year. Shinhan Bank introduced “Moneyverse” which provides customized investment opportunities in real estate and stocks, while Shinhan Card offers hyper-personalized services based on spending and consumption patterns, effectively leveraging the strengths of each business.

In addition to Shinhan SOL and Shinhan pLay, we have also built competitive lifestyle platforms in non-financial businesses. Launched by Shinhan Life Insurance in March 2021, “HowFIT”, a home training platform based on an AI motion recognition system, has won widespread recognition for its innovative features, thereby winning the grand prize for “2021 Self-development App of the Year” from Google Play. Shinhan Bank recently became the first company in the Korean financial sector to launch a delivery app, called “Ddaeng-gyoeyo”, and is building a mutually beneficial financial ecosystem within the food delivery market in partnership with store owners and delivery riders.

KEY MILESTONES

Innovation beyond Finance

Digital Inclusiveness



MARCH

Shinhan Life Insurance, launched “HowFIT”

OCTOBER

Shinhan Card, launched “Shinhan pLay”

NOVEMBER

Shinhan Bank, held a metaverse fan meeting in partnership with KBO

DECEMBER

Shinhan Bank, launched “Moneyverse”

Shinhan Card, launched a MyData service

Shinhan Bank, launched “Ddaeng-gyoeyo”



JULY

Shinhan Bank, opened a Digilog Branch

DECEMBER

Shinhan Bank, opened a digital branch tailored to senior customers

JANUARY, 2022

Shinhan Bank, showcased an “AI teller” at CES 2022

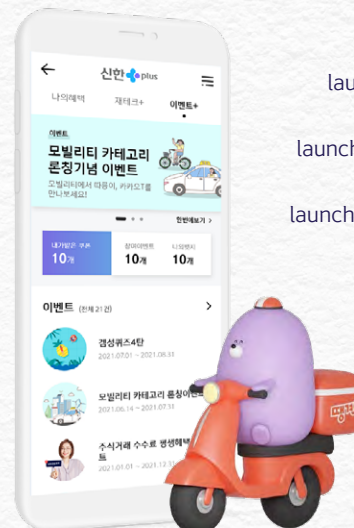

Digital ESG actions

Rather than perceiving digital transformation and ESG management as separate tasks, Shinhan seeks to ways to align them. At the “Digilog Branch”, a special digital branch launched in 2021, we have put in place AI tellers and cutting-edge digital technologies to help customers who are not used to digital technology, senior customers in particular. The services offered by our AI teller has redefined the concept of an offline channel. Our AI teller was even showcased at the 2022 Consumer Electronics Show (CES) held in Las Vegas in January, where it won extensive recognition for its innovativeness. Shinhan also seeks to offer a wider range of digital-based innovative services to our corporate clients through various means, including, among others, securing a partnership with an enterprise informatization system company with the largest SME client network in Korea. Going forward, we will support the growth of SMEs by providing Bank as a Service (BaaS), including specialized loans, through our ERP platform.

Increasing investments and adding alliances

In 2021, Shinhan became the first financial company in Korea to establish a digital strategic investment (SI) fund as a way to strengthen the Group’s key digital capabilities and to establish a digital ecosystem for the future. As of the end of 2021, we had invested a total of KRW 173.0 billion in 11 promising ventures, startups and unicorn companies of the future, in sectors as diverse as autonomous driving, a platform for trading second-hand goods, and a fashion e-commerce platform. This has expanded Shinhan’s distinctive digital ecosystem and has laid the foundation for a stronger collaboration for the Group’s future business.

Shinhan launched a startup accelerator program, “Shinhan Future’s Lab”, in 2015, another first record in the financial industry in Korea, enabling us to build long-term win-win relationships with globally competitive startups. As a cradle of the innovative technologies of the future, Shinhan Future’s Lab has established an ecosystem for mutual growth whereby identification of innovative companies leads to development and investment. It is also helping to accelerate the Group’s digital transformation.

Members of Shinhan Future’s Lab include companies with innovative ideas and leading technologies in such fields as fintech, content and big data, as well as in other sectors upon which Shinhan is placing a particular focus, including ESG, metaverse, and healthcare. In particular, ten startups fostered by Shinhan Future’s Lab were chosen for the “Baby Unicorn 200 Project” by the Ministry of SMEs and Startups, the most of any startup lab in the financial industry, thereby positioning Shinhan Future’s Lab as a leading startup accelerator program in Korea.

KEY MILESTONES

Helping Startups to Scale

JULY

Invested in “Insung Data”, a No. 1 in Korea in the last mile logistics market

Invested in “42dot”, a leading company of autonomous driving technologies

Invested in “PetEasy”, a peteconomy platform



SEPTEMBER

Invested in “Chang Healthcare”, a health care company

Invested in “Autohands”, a company specializing in used car trading and management

Invested in “Bungaejangter”, a top-tier second-hand goods trading platform

Invested in “Galaxy Corp.”, a company specializing in metaverse



OCTOBER

Invested in “BALAAN”, a luxury fashion ecommerce platform

Invested in “XINAPSE”, an AI-based voice/image synthesis solution provider

Invested in “Seoul Auction Blue”, an artwork investment platform



NOVEMBER

Invested in “ABLY”, a style commerce platform

Path-breaking approach

Building a better world through finance

ESG is now a vital part of business around the globe. As a company, we are required to think about climate change, human rights, inequality, and other universal issues which transcend time and space but which have sometimes been hidden in the shadows of rapid growth. Now is the time to pursue sustainable growth throughout society, and Shinhan's commitment to "Building a Better World through Finance" is precisely in line with this. In 2021, Shinhan established an ESG

slogan of the Group, "Do the Right Thing for a Wonderful World" and focused on the key ESG tasks that were put in place in 2020.

If it cannot be measured, it cannot be managed

Shinhan reemphasized this famous quote made by Peter Drucker during its participation at the UN Climate Change Conference (COP26) held in Glasgow, UK, last November. Based on this, we are establishing a detailed execution plan for a net-zero portfolio.

Shinhan became the first financial company in East Asia to formulate a strategy for carbon neutrality and declared the "Zero Carbon Drive" in November 2020. Zero Carbon Drive has set out our goal of achieving net-zero for our internal carbon emissions by 2044, and for financed emissions by 2050. We aim to reach the goals by measuring and managing emissions in line with global standards while engaging with targeted corporate clients. Moreover, we will leverage our membership within the UNEP FI Leadership Council to share our expertise on climate finance as a way to encourage more organizations to join in with our efforts.

Diversity creates a difference

We believe that diversity is a vital part of Shinhan Financial Group's sustainable development, and which is why we have set out "Shinhan Financial Group's Commitment to Diversity and Inclusion" in August 2021. In accordance with this commitment, we will ensure that we increase the number of female managers and foster more female leaders, while also widening the diversity of our Board of Directors and management. In 2021, we continued to provide mentoring, training, networking, and other opportunities to our future female leaders through "Shinhan SHeroes", a program to nurture female talent. In addition, we have set ourselves a challenging target for increasing the proportion of female managers, and we will strive to reach the goal.

ESG MANAGEMENT KEY MILESTONES

FINACE for IMPACT

MARCH

Shinhan Bank, declared its commitment to stop financing coal power



SEPTEMBER

Shinhan Financial Group, announced its ESG slogan "Do the Right Thing for a Wonderful World"

NOVEMBER

Shinhan Financial Group, became the first private financial company in Asia to be officially invited to COP26 and to share its net-zero ambitions

Shinhan Financial Group CEO Cho Yong-byoung, chosen as a member of the UNEP FI Leadership Council



Diversity & Inclusion



JANUARY

Shinhan Financial Group, included in the Bloomberg Gender-Equality Index for 3 consecutive years¹⁾



MARCH

Shinhan Financial Group, launched the 4th of Shinhan SHeroes

AUGUST

Shinhan Financial Group, declared "Shinhan Financial Group's Commitment to Diversity and Inclusion"

¹⁾ 4 consecutive years as of 2022

Looking forward

2022 marks the 40th year since the name “Shinhan” was unveiled. Building on our unique strength and enormous progress we have made over the years, we will continue striving to reinvent ourselves through innovation and creativity.

As part of this plan, Shinhan has been undergoing numerous major changes since 2021, starting with the Group’s cultural transformation. We also established a new vision for the Group, ensuring that we view finance from the perspective of our customers and the market. Our new corporate vision, which reads, “We believe finance should be More Friendly, More Secure, More Creative”, embodies the three most important values that customers look for in their finance partner – convenience, safety, and innovation – and the repeated word “more” reflects our promise to continually strive on behalf of our customers and to provide them with unique, distinctive solutions. We will focus all resources of every Group subsidiary on achieving our vision for our customers and the future.

Our value management system has also been changed. Our new core values – “Right”, “Nimble” and “Different” – will serve as a guiding principle for all of our employees and set the standards of how we operate our business, and will not just be a hollow slogan confined to a frame on a wall. All of us at Shinhan will make the “right” decisions for customers and for the future generations; accelerate the pace of execution by continuing to learn and grow in a “nimble” way; and respect the differences of each individual and create differentiated outcomes in a “different” way.

The Group’s strategic keyword for 2022 is “Breakthrough”. This keyword embodies our determination to break through an environment full of uncertainties, competition which seems to have no limits, and outdated customs or practices from the past. We will examine all our businesses and strategies from this new perspective and deliver exceptional value that exceeds expectations.

2022 marks the 40th year since the name “Shinhan” was unveiled. Building on our unique strength and enormous progress we have made over the years, we will continue striving to reinvent ourselves through innovation and creativity.



In closing

Dear fellow shareholders,

Shinhan Financial Group has a proud history that we have been shaping through ceaseless challenge and innovation. We now have a grand dream toward achieving "Excellence, Shinhan", and we are confident that we have sufficient resources to realize the dream. 2022 is the 40th anniversary of the founding of Shinhan, and all our employees will mark this momentous year by working in unison to provide distinctive value to customers and shareholders.

We thank you for your continuing support for Shinhan, and we look forward to what we will accomplish together in years ahead.

Thank you.

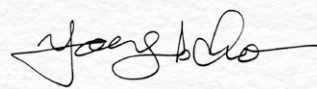

Cho Yong-byoung

Chief Executive Officer, Shinhan Financial Group

GOALS & STRATEGIC DIRECTIONS

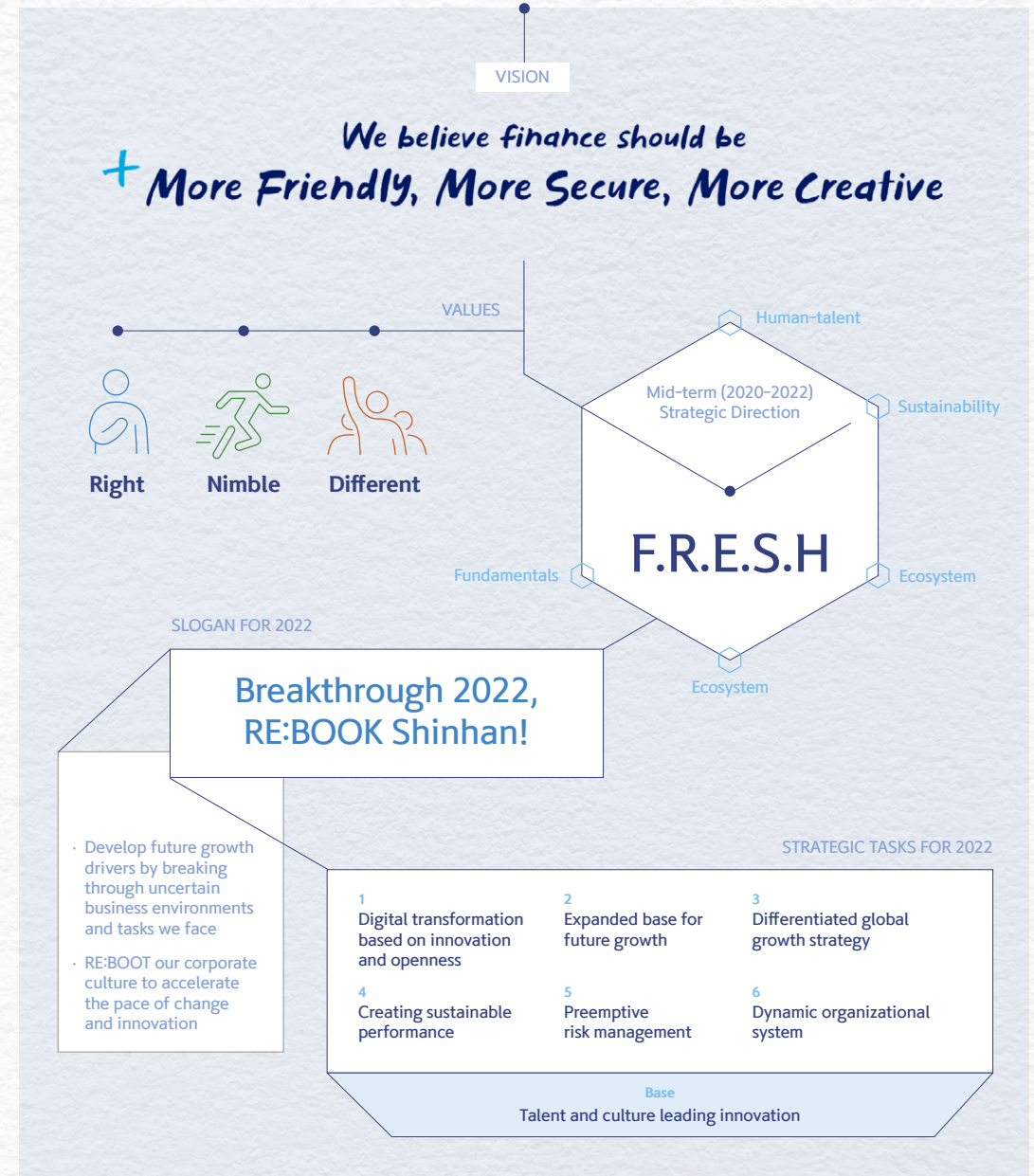

Shinhan Financial Group has been implementing its “F.R.E.S.H 2020s” mid-term strategy since 2020, so that it can evolve into an “Excellence, Shinhan” which earns recognition from all of its stakeholders by achieving distinctive growth even during times of complex uncertainty.

Based on the strategic growth directions set under F.R.E.S.H 2020s, in 2021 Shinhan Financial Group improved its fundamentals and thus implemented rapid changes, reflecting the circumstances during the COVID-19 crisis. Looking to the next year, we will build on these efforts to produce higher, more consistent returns by enhancing the growth potential of the Group, and to improve our valuation.

F.R.E.S.H 2020s



Mid-term Strategic Direction

F.R.E.S.H 2020s

HUMAN-TALENT
Versatile and talented people to lead future growth

SUSTAINABILITY

Executing a coherent Group-wide strategy towards a more sustainable future

ECOSYSTEM

Building a digital ecosystem to elevate digital competitiveness

RESILIENCE

Strengthening resilience, the ability to recover quickly from adversity

FUNDAMENTALS

Maximizing corporate value by fortifying fundamentals

Mid-term Strategy Roadmap

2022

ACCELERATING THE CHANGE

On the back of strengthened fundamentals, fully accelerate the change towards "Excellence, Shinhan"

Achieve breakthrough growth for greater future growth potential

2021

STRENGTHENING FUNDAMENTALS & IMPLEMENTING THE CHANGE

Strengthen fundamentals by increasing portfolio and key business efficiency based on customer trust and proper response to crises. At the same time, explore opportunities and implement change for future growth

2020

SETTING DIRECTIONS & EMBRACING THE CHANGE

Present a mid-term strategic direction in response to increased volatility, including, among others COVID-19, and make new attempts for new change

MAXIMIZING CORPORATE VALUE BY FORTIFYING FUNDAMENTALS

Group Net Income
(Unit: KRW billion)

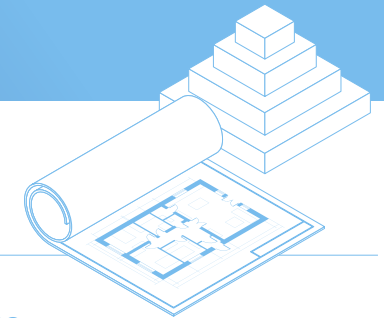
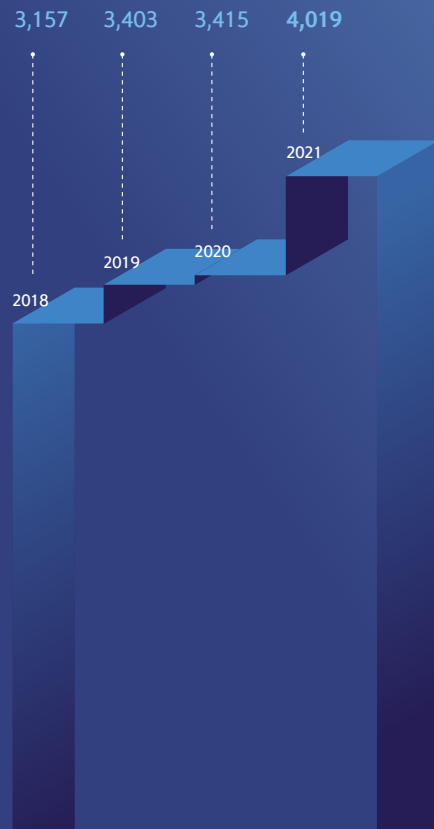

Record-high performance results attesting to our strong fundamentals

The global economy grew by well over 5% in 2021 thanks to policy responses by governments around the world to help their economies recover from the pandemic. The Korean economy achieved year-on-year growth of 4% on the back of strong exports of key products, increased private consumption attributable to successful vaccination programs, and extended social infrastructure investments. Private consumption led growth in the second quarter, but fell by 0.2% in the third quarter from the previous quarter as a result of social distancing driving down the use of face-to-face services. The impact from the strengthened quarantine measures steadily decreased over time as consumers learned to live with the prolonged impact of COVID-19. In 2021, the Korean economy therefore broke away from the previous year's contraction and grew significantly, mainly attributable to strong exports and facility investments.

Even in the midst of continued uncertainty, in 2021 Shinhan Financial Group had a year of record consolidated net income in controlling interest of KRW 4,019.3 billion, a year-on-year increase of 17.7%, continuing growth pace for eighth consecutive years. Major factors in this achievement include: (1) solid asset growth, which in turn generated reliable interest income; (2) portfolio diversification in response to ultra-low interest rates, leading to increased non-banking income; (3) increased non-interest income from matrix organizations, a key driver of our mid-to long-term growth; (4) preemptive and systematic risk management in response to the effects of COVID-19 and the issues related to problems at certain private equity funds, including Lime Asset Management.

In particular, in the second half of the year, we actively worked on private reconciliation in order to regain customer trust and eliminate uncertainties surrounding potential losses. We estimated losses at the maximum level indicated by global accounting standards, and recognized a loss on investment products of KRW 467.6 billion as non-operating expenses for 2021, thus minimizing future uncertainty.

Strong net interest income generation backed by robust asset growth

The Group interest income increased 11.0% year-on-year on the back of strong growth in loans, especially at Shinhan Bank, Shinhan Card and Shinhan Capital, and higher market interest rates. The cumulative net interest margin of the Group, which includes Shinhan Bank and Shinhan Card figures, increased slightly year-on-year due to two base rate hikes of 25 basis points in August and November 2021, respectively. The margin is on the increase following another 25bp interest rate rise in January 2022. Going forward, we will continue to aim for improved net interest margin through advanced asset-liability management (ALM).

Shinhan Bank's loans in KRW grew by 9.0% year-on-year in 2021, achieving balanced growth across both retail and corporate loan sectors. Retail loans grew by 7.4%, and corporate loans rose 10.6%. SME loans and SOHO loans, in particular, grew at an annual growth rate of 12.8% and 12.7%, respectively, leading the overall growth.

The robust growth in loans was mainly attributable to our commitment to funding SMEs and SOHOs which have been experiencing difficulties due to the pandemic. We will continue to aim for stable growth in 2022 through selective loan policies and thorough risk monitoring.



Portfolio diversification leading to increased non-banking income

The Group's non-banking sector has boosted the Group's ability in generating incomes, especially in an era of ultra-low interest rates. Despite challenges posed by the exceptionally low interest rates and increased competition, Shinhan's continued efforts to enhance non-interest earnings led to tangible business performance in 2021. Non-interest income grew by 7.7% year-on-year, largely driven by strong increases in fees and commissions income (+12.3%) and securities-related income (+25.0%), making non-interest income account for 28.7% of total net income.

In particular, brokerage fees rose 125% in 2020 thanks to increased trading volume and further grew by 5.8% in 2021 year-on-year as a result of a continued capital market activity. In addition, the operations under the Group matrix business structure performed strongly and resulted in a year-on-year increase of 16.9% in investment banking fees and commissions.

We will continue to expand our key non-interest businesses, and thus focus on developing growth engines for continued sustainable and resilient business momentum.

The Group's G&A expenses increased by 10.2% year-on-year to KRW 5,743.1 billion, mainly attributable to KRW 268.1 billion in costs from a large-scale early retirement program undertaken in 2021, and increased advertising expenses in support of the Group's digital platform and new businesses.

However, the Group's cost-to-income ratio (CIR), excluding the aforementioned early retirement expenses, stood at 43.1%, a year-on-year improvement of 1.3%p, thanks to the increase in income, more efficient work processes, in part driven by the growing number of digital customers, and better cost management.

Sound asset quality and stable CCR even after securing additional buffer for soft landing post-COVID-19

The Group's non-performing loan (NPL) ratio stood at 0.39% at the end of 2021, down 0.1%p compared to the previous year as a result of focusing on growth based on high quality assets despite the extensive uncertainties at home and abroad. Despite economic volatility and the resulting risks, Shinhan Bank's NPL ratio improved by 9bp to 0.27% on the back of preemptive risk management and quality asset-based growth.

As of the end of 2021, the delinquency ratio of both Shinhan Bank and Shinhan Card improved to 0.19%, a year-on-year decrease of 4bp, and 0.80%, a year-on-year reduction of 24bp, respectively. A benign delinquency trajectory is observed in the Group's major subsidiaries, and the Group's asset quality is therefore forecast to remain strong. We have secured additional buffer through conservative COVID-related provisions, and thus recorded stable NPL coverage ratio, which, as of the end of 2021, stood at 195.3%.

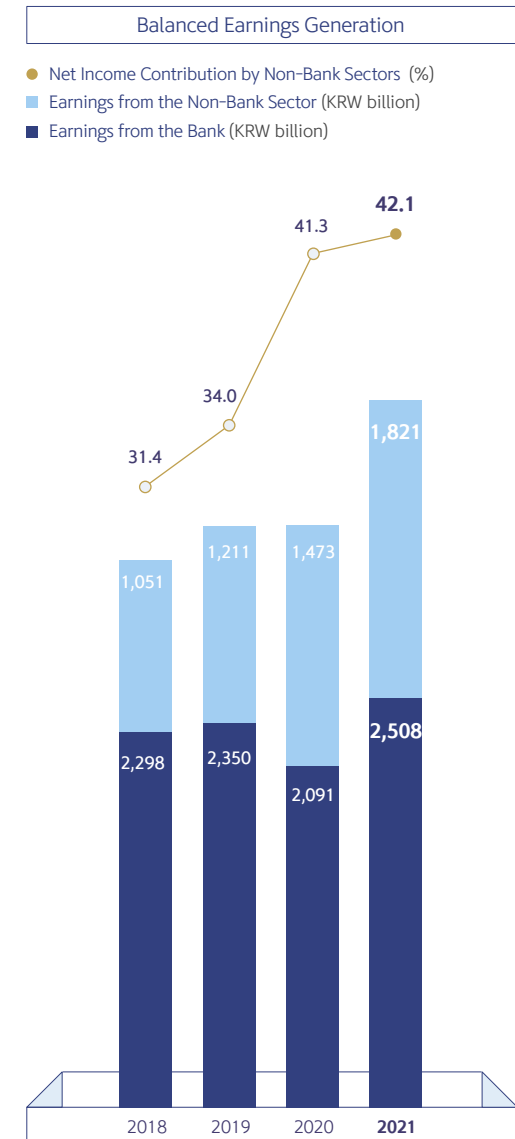

The Group's credit costs fell by KRW 394.2 billion or 28.3% year-on-year to KRW 996.4 billion. This is mainly attributable to the base effect, where big sums of provisions were made in 2020 against the possibility of companies becoming insolvent due to COVID-19 and uncertainties in the domestic economy. We will continue to actively manage risk through detailed monitoring of the impact of COVID-19 and economic trends at home and abroad.

On the back of continued growth of net income, the Group's BIS ratio, a key indicator of the Group's capital strength, improved by 46 basis points year-on-year to 16.2% at the year-end, while the Common Equity Tier 1 ratio also rose by 23bp to 13.1%. The CET 1 ratio is estimated at 11.8% before reflecting the revised Basel III credit risk framework put in place in September 2020. Scheduled to be implemented in 2022, the revised Basel III framework, which includes revisions to the measurement of market risk and operational risk, is expected to reduce the Group's CET 1 ratio by 65bp to 100bp. In response, we are maintaining stable and efficient capital management.

The Group's return on equity (ROE) improved by 0.8%p year-on-year to 9.2% thanks to increased profitability at subsidiaries with a high ROE, including Shinhan Capital and Shinhan Asset Management. Shinhan Financial Group will continue to improve its capital adequacy and profitability by expanding its core earnings base and through strong net income growth.

Group BIS Ratio ¹⁾

	Dec. 2021	Dec. 2020	YTD %
Risk Weighted	270,692	252,321	7.3%
Capital	43,863	39,709	10.5%
CET 1	35,470	32,462	9.3%
Tier 1	40,435	36,267	11.5%
BIS ratio	16.2%	15.7%	0.46%p
CET 1 Ratio	13.1%	12.9%	0.23%p
CET 1 Ratio ^(old)	11.8%	11.8%	0.07%p
Tier 1 Ratio	14.9%	14.4%	0.57%p

(Unit: KRW billion)

Shinhan Bank BIS Ratio ¹⁾

	Dec. 2021	Dec. 2020	YTD %
Risk Weighted	177,098	165,264	7.2%
Capital	32,197	30,525	5.5%
CET 1	26,069	24,662	5.7%
Tier 1	27,566	26,249	5.0%
BIS ratio	18.2%	18.5%	-0.3%p
CET 1 Ratio	14.7%	14.9%	-0.2%p
CET 1 Ratio ^(old)	11.5%	12.1%	-0.5%p
Tier 1 Ratio	15.6%	15.9%	-0.3%p

(Unit: KRW billion)

¹⁾ Based on Basel III; and reflecting the early adoption of the revised Basel III credit risk framework

Resilient business performance across business units

The following table is a snapshot of the financial performance of Shinhan Financial Group's subsidiaries in 2021.

(Unit: KRW billion)

		Net Profit (before reflecting ownership)			Ownership
		2021	2020	YoY %	
BANK		2,512.8	2,095.3	19.9%	
	Shinhan Bank	2,494.4	2,077.8	20.0%	100.0%
	Jeju Bank	18.4	17.5	5.3%	75.3%
NON-BANK		1,852.4	1,501.1	23.4%	
Consumer Finance	Shinhan Card	675.0	606.5	11.3%	100.0%
	Shinhan Savings Bank	30.3	27.0	12.5%	100.0%
Insurance	Shinhan Life Insurance ¹⁾	391.6	457.1	-14.3%	100.0%
Capital Markets	Shinhan Investment Corp	320.8	154.8	107.3%	100.0%
	Shinhan Capital	274.9	160.6	71.2%	100.0%
	Shinhan Asset Management ²⁾	32.2	26.7	20.6%	100.0%
	Shinhan Alternative Investment	9.2	3.4	166.9%	100.0%
	Shinhan REITs Management	8.5	3.8	125.3%	100.0%
	Asia Trust	77.8	45.8	69.9%	60.0%
	Shinhan AI	0.5	0.3	57.2%	100.0%
	Shinhan Venture Investment ³⁾	15.9	-1.1	n.a.	100.0%
Others	Shinhan DS	4.1	1.9	120.2%	100.0%
	Shinhan AITAS	9.8	13.0	-24.6%	99.8%
	Shinhan Credit Information	1.9	1.5	29.7%	100.0%

¹⁾ OrangeLife Insurance was merged into Shinhan Life Insurance on July 1, 2021

²⁾ Shinhan BNP Paribas Asset Management was renamed to Shinhan Asset Management on January 15, 2021

³⁾ Neoplux was newly acquired on SEPT 29, 2020; and was renamed to Shinhan Venture Investment on January 11, 2021

Shinhan Bank's solid income growth backed by robust growth

Shinhan Bank's net income rose by 20.0% year-on-year in 2021 to KRW 2,494.4 billion, mainly attributable to the strong interest income growth of 6.3% year-on-year on the back of growth in KRW loans and a wider net interest margin. However, non-interest income fell by 24.1% owing to lower bancassurance fees and reduced income from securities and derivatives. Provisioning for credit losses fell by 49.8% year-on-year due to a base effect of major COVID19-related provisions set aside in 2020. Loans in KRW at the year-end increased by 9.0% in 2021 to KRW 271.1 trillion – retail loans increased by 7.4% and corporate loans rose by 10.6%, contributing to the strong overall growth. In addition, the net interest margin for the year improved by 4bp, thanks to base rate hikes in 2021.

Within the fees and commissions income, trust fees and fund fees rose, but bancassurance fees fell by 0.9% year-on-year. Gains on valuations of securities fell by 24.6% owing to a decrease in bond-related income. G&A expenses rose by 4.9% year-on-year, mainly attributable to the large-scale early retirement program, but remain within the planned range. Looking into the years ahead, and the digital transformation at Shinhan is expected to enable more efficient management of G&A expenses. Shinhan Bank's cost-to-income ratio (CIR) stood at 46.1% as a result of improvements in efficiency and higher pre-provision operating income, attesting that our productivity is on the rise. The credit cost ratio was stable at 11bp, thanks to qualitative asset growth and prudent credit risk management, despite increases in provisions caused by the increased economic volatility.

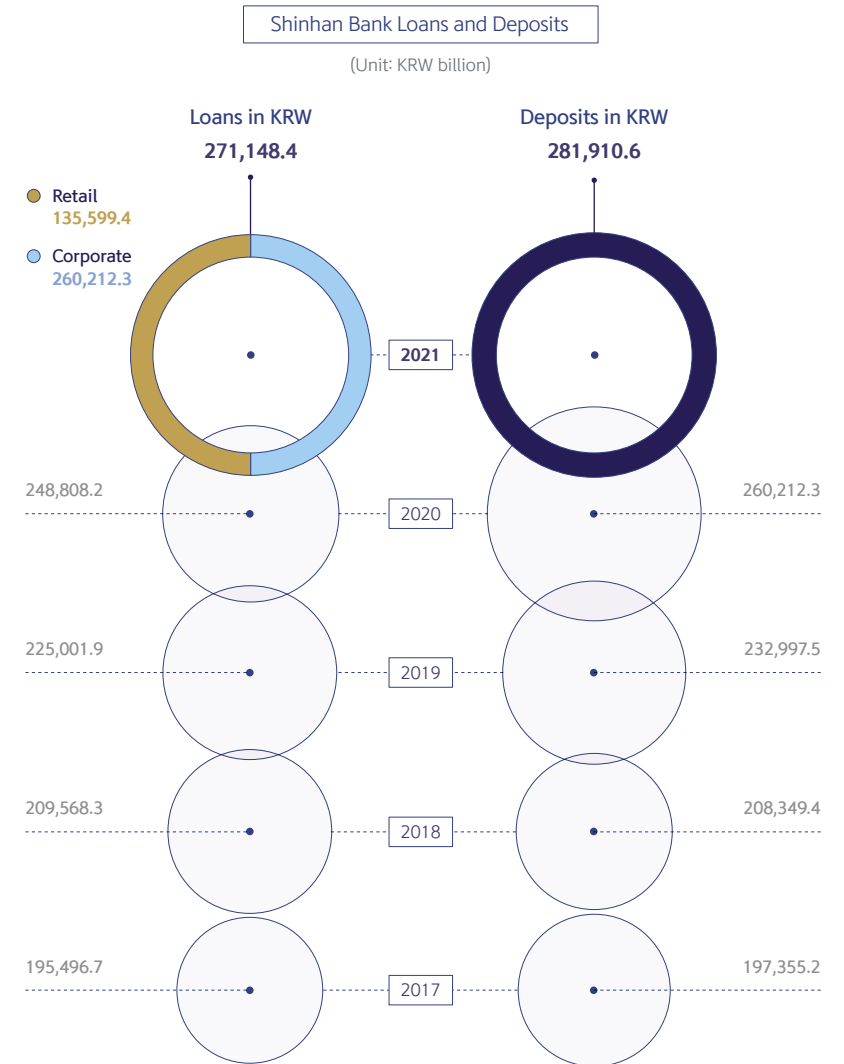
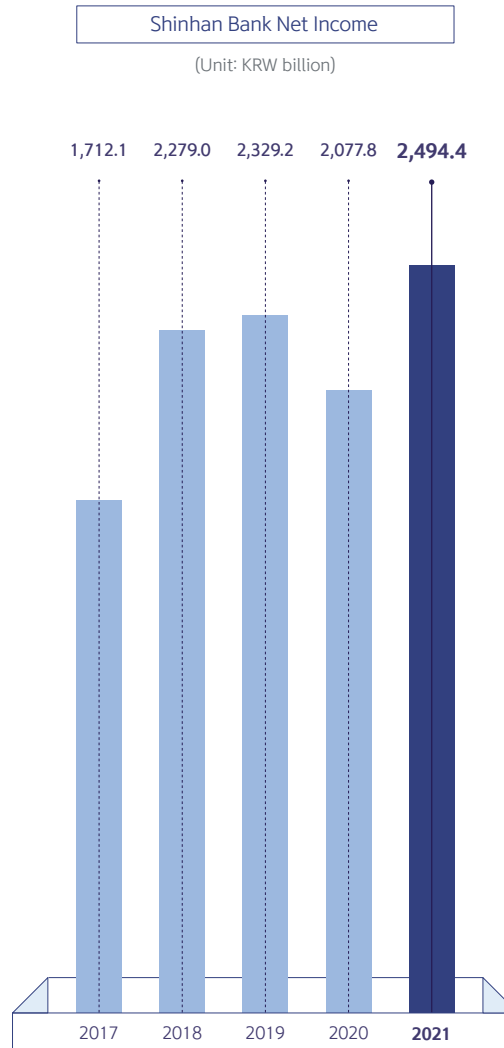

Shinhan Card, weathering the storm with a diversified business portfolio

Net income of Shinhan Card in 2021 rose by 11.3% year-on-year to KRW 675 billion. This was largely driven by the expansion of the digital payments market, in line with the recent contactless business trend. It was also the result of our efforts to generate revenues across a wider range of businesses, including leases and installment finance, in order to overcome the negative impact on credit card revenues caused by cuts in merchant service fees. As a result, operating revenues from credit card payments went up by 0.5% year-on-year, while operating revenues from leases and installment finance rose by 36.4% and 7.6%, respectively. We will strive to improve profitability by generating growth in new businesses and by lowering G&A expenses, including marketing expenses.

The one month or longer delinquency ratio at the end of December stood at 0.80%, 24bp lower than the year before, while the NPL ratio was 0.87%, and the NPL coverage ratio was 337%, indicating asset quality soundness of Shinhan Card.

Shinhan Card Net Income Trend

(Unit: KRW billion)

Despite headwinds, Shinhan Card's recurring earnings have been resilient by building a diversified business portfolio coupled with strong top-line growth.

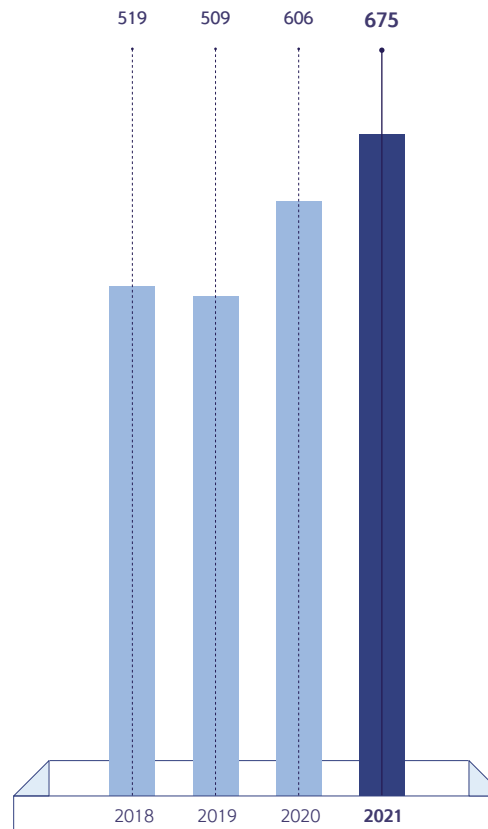

Shinhan Card Earning Assets Trend

(Unit: KRW trillion)

● Credit Card ● Cash Advance
● Card Loan ● Installment ● Lease

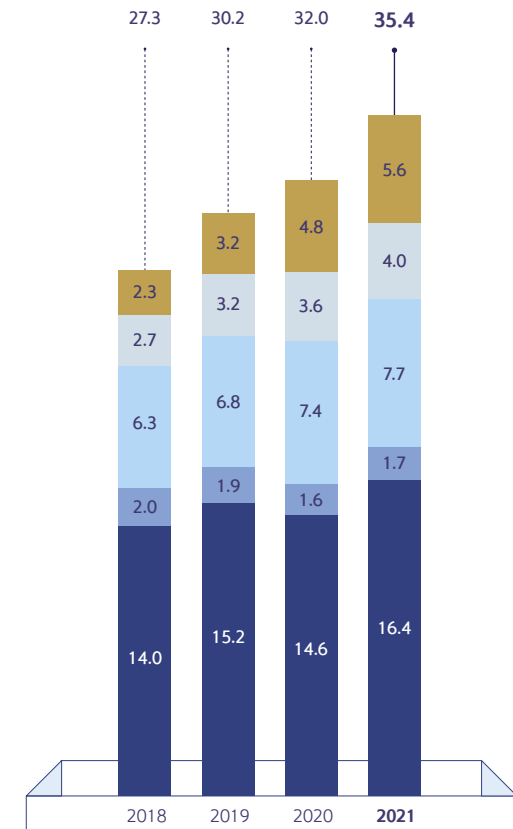

Other Subsidiaries

Shinhan Investment recorded net income of KRW 320.8 billion in 2021, up 107.3% compared to the previous year. Increased stock market trading volumes led to a year-on-year increase of 11.1% in brokerage fees, and IB fees rose by 28.9% as our GIB (Group and Global Investment Banking) business segment generated stable operating revenues, thereby leading the overall growth in fees and commissions income. In addition, Shinhan Investment took measures to minimize future uncertainties and regain customer trust by, for instance, preemptively recognizing the costs related to losses on investment products through private reconciliation.

Shinhan Life and OrangeLife merged into Shinhan Life Insurance on July 1, 2021, and when including OrangeLife’s net income in the first half of 2021, Shinhan’s insurance arm’s consolidated net income fell by 14.3% year-on-year, to KRW 391.6 billion in 2021. This is attributable to an increase in claims paid; decreases in the mortality and morbidity margins and the mortality margin ratio; and one-off costs from a large-scale early retirement program, despite an increase in investment margins and stronger interest and dividend income. As the merger of Shinhan and Orange Life has been completed, synergies between the two will enable the new company to adapt to a rapidly-changing market environment, including the implementation of new global accounting standards (IFRS 17) and new Korean financial supervision (K-ICS) standards, and thus grow into a leader in the domestic life insurance sector.

Shinhan Capital’s net income rose by 71.2% year-on-year to KRW 274.9 billion. This was mainly attributable to a 25.1% increase in operating revenues, which in turn was a result of higher interest income from increased loan assets, and stronger income from investment securities. Provisioning for credit losses decreased by 47.4% year-on-year, and asset quality stayed benign. Total assets at the end of December 2021 stood at KRW 10.9 trillion, a year-on-year increase of 22.7%. Shinhan Capital will continue its sound asset growth, and will generate stable income based on systematic financial management and rigorous risk management.

Diversified Profit Base

- Shinhan Card, Shinhan Savings Bank
- Shinhan Life Insurance
- Shinhan Investment, Shinhan Capital, Shinhan Asset Management, Shinhan Alternative Investment, Shinhan REITs Management, Asia Trust, Shinhan AI, Shinhan Venture Investment
- Others

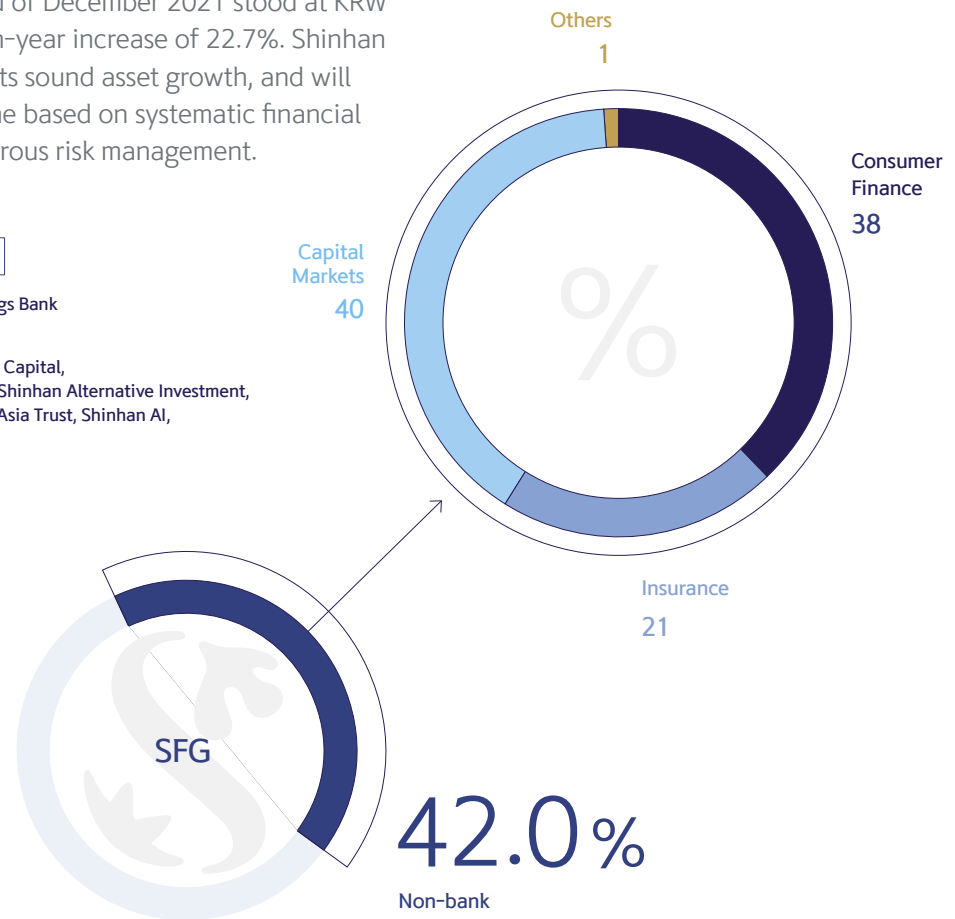

CFO's Reflections on Our Fundamentals

FORTIFYING FUNDAMENTALS AND DRIVING SHAREHOLDER VALUE



Lee Taekyung

Chief Financial Officer, Shinhan Financial Group

With the prolonged pandemic and ultra-low interest rates, 2021 was indeed an extraordinary year. As we head to 2022, other sets of uncertainty awaits . Depending on how COVID-19 progresses, how much inflation rises and the currency falls, and how the global economy, including the global supply chain, takes the impact of wars and other geopolitical instabilities, the Korean economy will likely be shaped. COVID-19 is expected to continue to spread and impact the real economy.

In addition, markets are anticipating a steady increase in interest rates from the US Federal Reserve, which is likely to cause base rates in Korea to rise. With various factors leading to the instability of global supply chains, there are increasing concerns over the possibility of inflation and falling exports.

While continuing to manage potential risks and assist our clients navigate through the volatile times, we will focus on improving the use and allocation of our capital, building greater presence and influence in the capital markets, and enhancing our digital competitiveness. Generating effective returns from our interest income will also be a focus.

Looking ahead, we will work towards delivering a more predictable shareholder returns with regular quarterly dividend payments, and also examine various other means of shareholder return, including share buybacks and cancellations, taking into account the economic environment, share price, net income, and other factors such as asset growth and quality.

We will fully leverage the favorable interest rate environment that is widely expected for 2022 by building a growth momentum on the back of asset growth based on loans to SMEs and improving our net interest margin (NIM) and interest income through efficient management of our asset & liability portfolio and staying nimble with the implementation of effective ALM strategies based on flexible interest rate policies. We plan to balance the growth in interest income with further growth of our non-banking sector. In consideration of the stricter regulations regarding credit card business, there will be a particular focus on expanding our capital markets business, and we will seek to continuously enlarge the proportion of the Group income made up of non-banking income.

We will make continued efforts to implement stable asset quality management. Although credit costs could increase as interest rates rise and COVID-19 financial support programs are brought to an end, the credit cost ratio (CCR) is expected to be around the same level as in 2019, which is the pre-COVID 19 level.

Notwithstanding, in order to prevent a deterioration in asset quality being brought on by increases in interest rates, Shinhan is already monitoring borrowers who are particularly sensitive to interest rates, and is also putting into place a screening processes based on repayment capacity. Furthermore, we are undertaking in-depth monitoring of the impact on the Group of increased volatility in financial markets and the real economy, and thus identifying any issues and then establishing detailed response strategies for each area of risk, including liquidity, credit, asset quality and consumer protection.

We are maintaining an appropriate level of capital based on our stable profitability and efficient capital management. Our strategic organic and inorganic growth has also prepared us for increased external volatility, including the prolonged COVID-19 pandemic. As of the end of 2021, the Group's CET 1 ratio stood at 13.1%, a sufficient buffer secured over the regulatory requirement of 10.5%¹⁾. Shinhan will continue to strictly comply with the ratios set out in regulations, while also creating internal reserves of additional capital to prepare for inorganic growth and any unforeseen eventualities. In addition, we will implement flexible capital policies as part of our ongoing efforts to enhance shareholder value.

Shinhan Financial Group initiated its quarterly dividend payouts in the second quarter of 2021 is part of our commitment to enhancing shareholder value. Looking ahead, we will work towards delivering a more predictable shareholder returns with regular quarterly dividend payments, and also examine various other means of shareholder return, including share buybacks and cancellations, taking into account the economic environment, share price, net income, and other factors such as asset growth and quality.

¹⁾ CET 1 ratio of 10.5% equals the regulatory requirement CET 1 ratio of 8% plus a countercyclical capital buffer of 2.5%.

STRENGTHENING RESILIENCE, THE ABILITY TO RECOVER QUICKLY FROM ADVERSITY

COVID-19 Provisioning
(Unit: KRW billion)

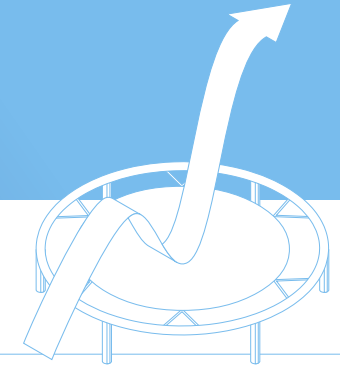
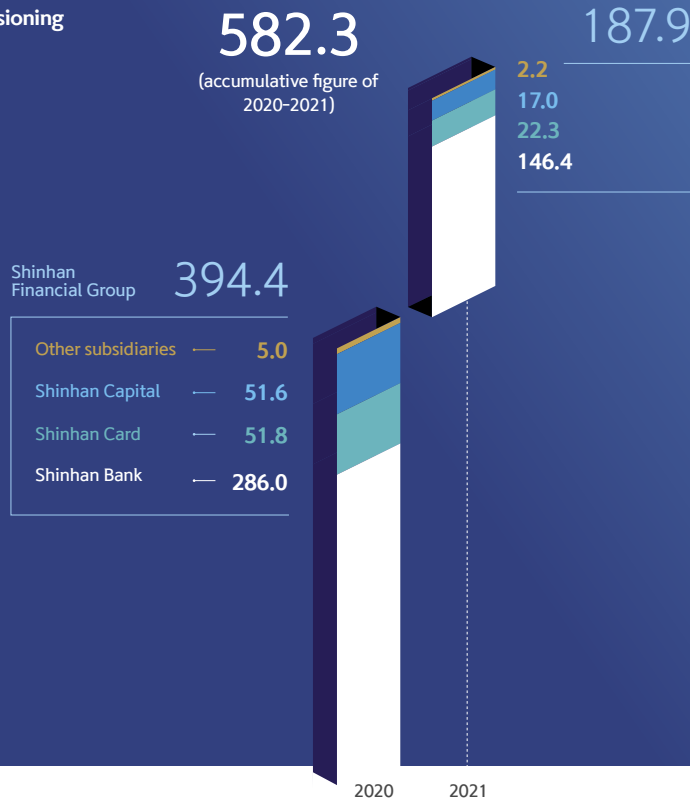

Risk management for resilience in the pandemic era

Guided by a strategy of “solid risk management to enhance our resilience”, Shinhan Financial Group in 2021 improved its risk management processes while also strengthening its risk responsiveness.

As a preemptive response to the potential risks caused by the prolonged COVID-19 pandemic, we have assessed the key risks for each Group subsidiary and set up targeted monitoring systems for each risk identified. We looked closely at those areas expected to be most impacted by the pandemic, defined key risks to be monitored, and set the critical points in the early detection of risk, enabling us to analyze causes when a critical point has been surpassed and to react accordingly in a timely manner. We collaborated with Shinhan AI to improve our early risk detection through the Market Warning System (MWS), and assessed how each Group subsidiary would react once a risk had been detected through this AI-based system. We continue to operate a Group-level crisis response system for the COVID-19 pandemic, including regular meetings of the Group Risk Management Council. In addition, we took practical action by putting into place detailed crisis recognition measures and undertaking in-depth analyses of financial markets.

In detail, we conducted stress tests around a number of scenarios and timely examinations of credit, liquidity and market risks, in preparation for increased financial market volatility, and established effective countermeasures.



Improving early detection of risk by using Shinhan's AI-based Market Warning System (MWS)

For market risk, we examined the portfolio of the Group subsidiaries and improved their responses to fluctuations in financial markets, which has enabled us to assess the impact on the Group's asset value of rapid changes in interest rates, stock prices, and exchange rates.

These actions have strengthened the Group-level resilience, enabling Shinhan Financial Group to maintain stability even in the face of the prolonged pandemic.

Risk management for resilience in the pandemic era

Guided by a strategy of "solid risk management to enhance our resilience", Shinhan Financial Group in 2021 improved its risk management processes while also strengthening its risk responsiveness.

As a preemptive response to the potential risks caused by the prolonged COVID-19 pandemic, we have assessed the key risks for each Group subsidiary and set up targeted monitoring systems for each risk identified. We looked closely at those areas expected to be most impacted by the pandemic, defined key risks to be monitored, and set the critical points in the early detection of risk, enabling us to analyze causes when a critical point has been surpassed and to react accordingly in a timely manner. We collaborated with Shinhan AI to improve our early risk detection through the Market Warning System (MWS), and assessed how each Group subsidiary would react once a risk had been detected through this AI-based system.

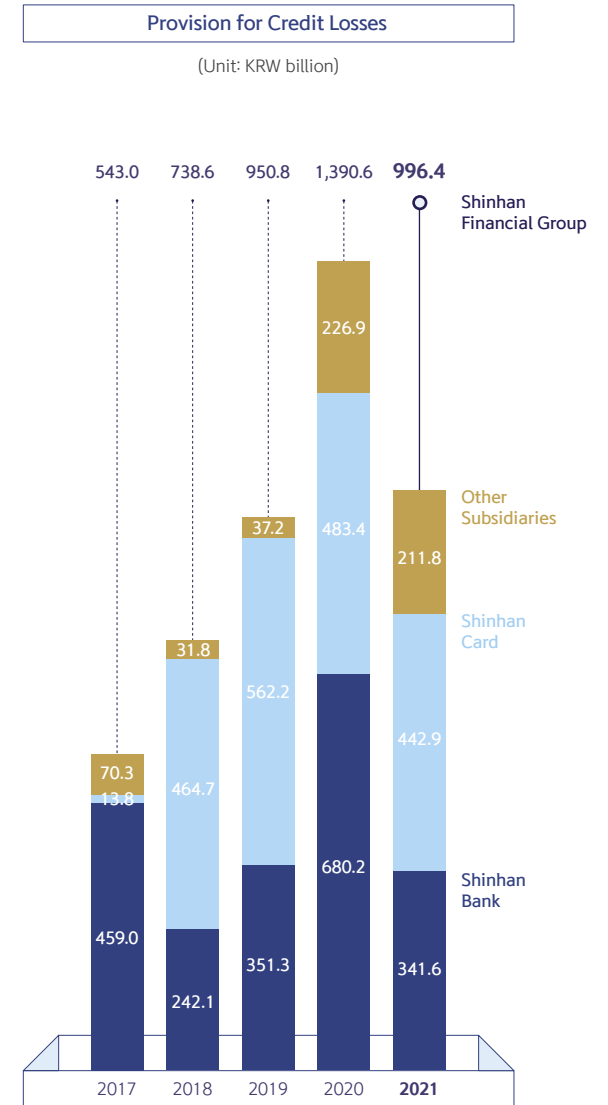

We continue to operate a Group-level crisis response system for the COVID-19 pandemic, including regular meetings of the Group Risk Management Council. In addition, we took practical action by putting into place detailed crisis recognition measures and undertaking in-depth analyses of financial markets.

In detail, we conducted stress tests around a number of scenarios and timely examinations of credit, liquidity and market risks, in preparation for increased financial market volatility, and established effective countermeasures. For credit risk, we examined areas of vulnerability when interest rates rise, which include heavy debtors, marginal firms, and borrowers supported by loan rescheduling and interest-deferral programs, to put countermeasures into place. We also strengthened our management of those industries which are most affected by fluctuating exchange rates and rising raw material prices. In particular, in IB business, we began monthly loan reviews for our overseas real estate and alternative investments, sectors which have been severely impacted by COVID-19.

For liquidity risk, the liquidity funding structures and emergency funding plans of each Group subsidiary were re-examined in the light of a potential liquidity crunch caused by increases in funding rates. In addition, we created a liquidity dashboard for our global branches to strengthen their monitoring of vulnerable areas such as rapid withdrawals from emerging country funds. For market risk, we examined the portfolio of the Group subsidiaries and improved their responses to fluctuations in financial markets, which has enabled us to assess the impact on the Group's asset value of rapid changes in interest rates, stock prices, and exchange rates.

These actions have strengthened the Group-level resilience, enabling Shinhan Financial Group to maintain stability even in the face of the prolonged pandemic.

Credit Cost Ratio

	2017	2018	2019	2020	2021
Shinhan Financial Group	0.21	0.26	0.31	0.41	0.27
Shinhan Bank	0.21	0.10	0.14	0.24	0.11
Shinhan Card	0.05	1.64	1.84	1.48	1.24

(Unit: %)

NPL & NPL Coverage

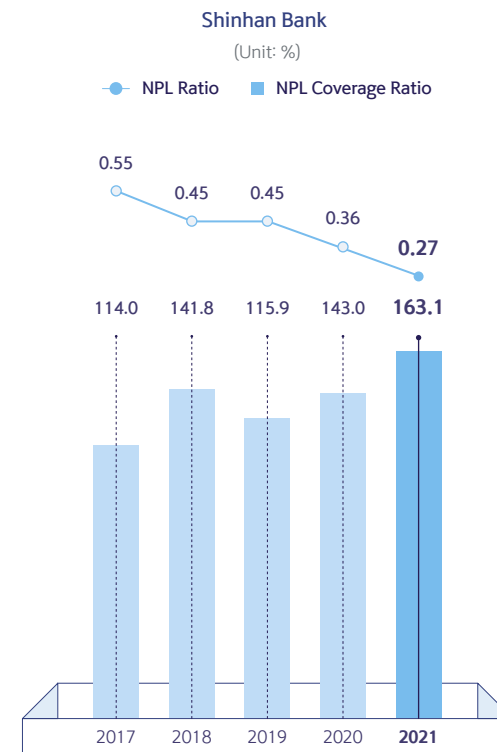
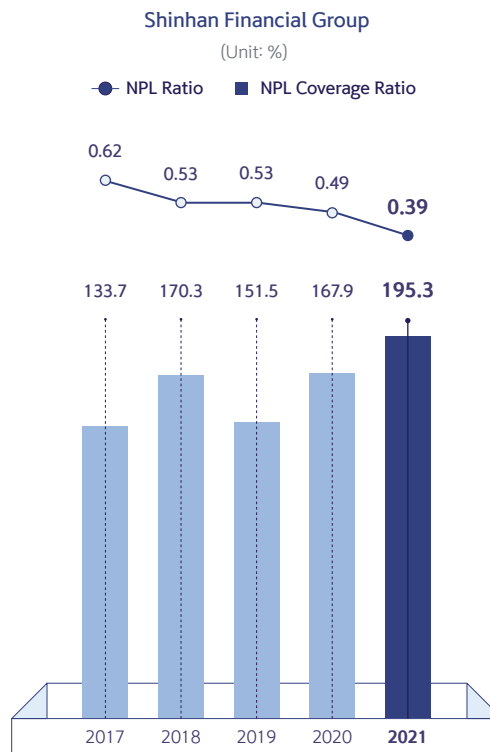

FEATURED CASE

Environmental Risk Management System

Financial institutions across the globe are striving to manage ESG factors and climate change and integrate them into their decision-making systems, especially as climate change response and disclosure frameworks such as the TCFD are resulting in a greater need to measure the financial impact of climate change and disclose the outcomes to external parties.

Recognizing the importance of ESG, Shinhan has been ahead of the curve, and in 2018 we became the first company in Korea to establish an Environment and Social Risk Management Policy (ESRM) Framework to manage the ESG aspects of our loans and investments. Our ESRM Framework includes our policy on limiting our involvement with coal power generation, monitoring selected areas of interest¹⁾, and assessing the environmental impact of large-scale development project financings. If a PF is assessed to potentially have a negative impact on the environment, we insist on measures to eliminate or minimize environmental damage, and reflect those conditions in financial contracts.

Environmental and Social Risk Review Procedure

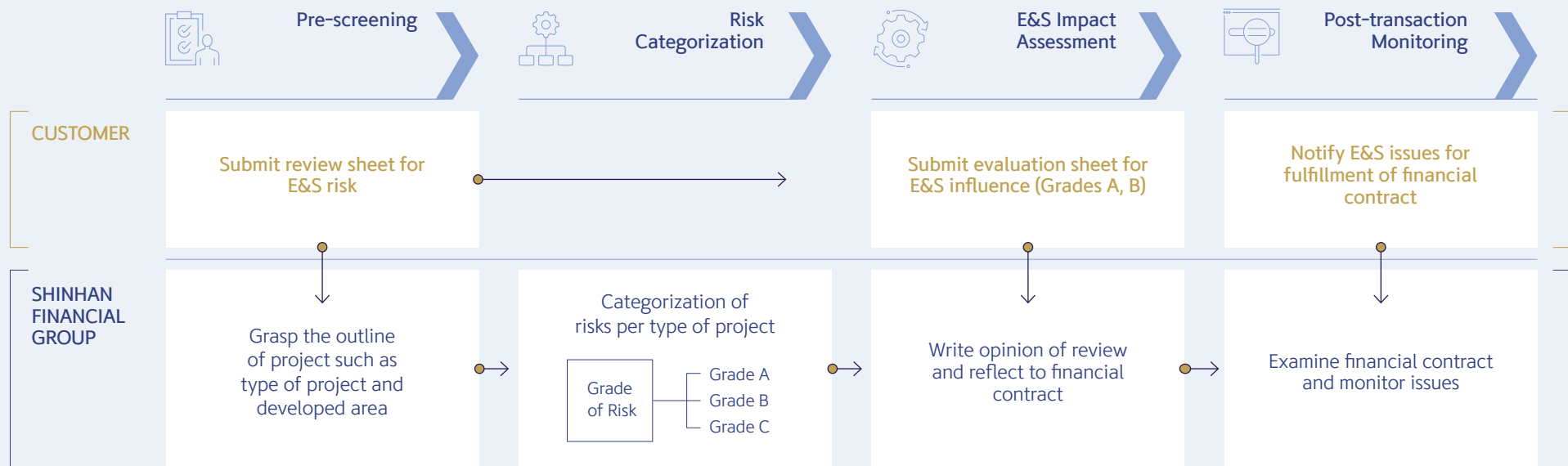

¹⁾ Shinhan Financial Group has selected 12 areas of interest regarding global warming, biodiversity and industrial safety in line with the guidelines of International Finance Corporation (IFC) and manages these areas of interest under its ESRM Framework.



In accordance with our assessment of how the transition and physical risks from climate change impact financial institutions, we are analyzing its impact on our portfolio and taking measures in response. In particular, Shinhan is the first company in Korea to develop a system for calculating the Group’s financed emissions, which is helping us to identify the impact of climate change on the Group’s portfolio and the related risks. We also collect data on GHG emissions, financial information, and other relevant data from the Group portfolio companies, and regularly measure the Group’s financed emissions using criteria set out by the Partnership for Carbon Accounting Financials (PCAF). This system allows us to measure financed emissions for each Group subsidiary and by asset, industry and defined business sector, enabling varied and highly detailed analyses. Moreover, we have incorporated an additional financed emissions simulation function which allows us to identify changes in financed emissions levels caused by a new transaction as well as the emissions level of a corporate client.

In the short term, the system will be used to identify areas that are vulnerable to climate change, and to enable us to put the right responses in place. Over the long term, it will be used to help our clients with their transition to a low-carbon economy through targeted financial support and to effectively manage our portfolio. In addition, we will improve our measurements and increase the amount of climate-related data we collect and analyze, and incorporate the financed emissions calculation system in our climate scenario analyses.



Please refer to our 2021 TCFD report for details.

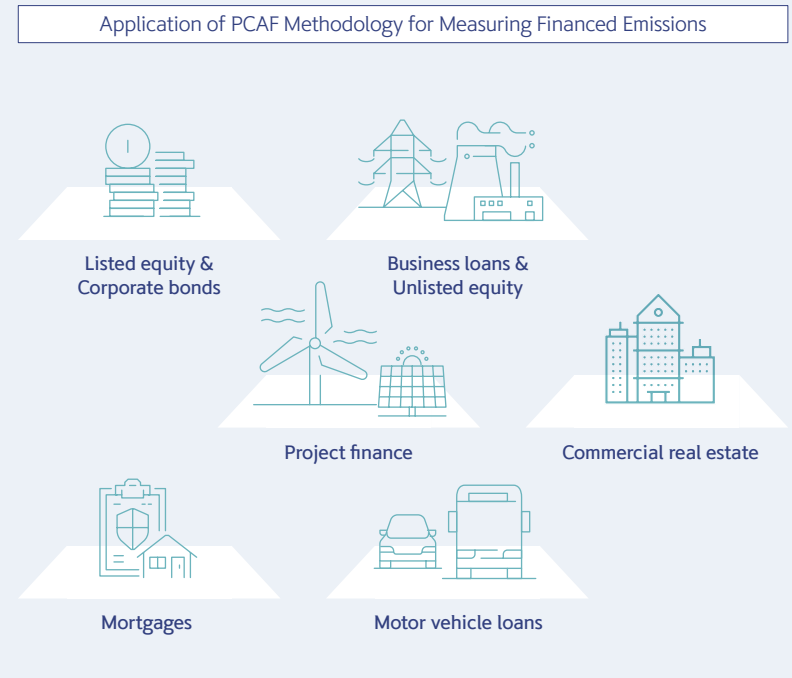

The methodology from the *PCAF Global GHG Accounting & Reporting Standard for the Financial Industry* was applied to measure the financed emissions of Shinhan Financial Group’s asset portfolio. In accordance with the PCAF Standard, six asset classes – listed equity and corporate bonds, business loans and unlisted equity, project finance, commercial real estate, mortgages, and motor vehicle loans – are included in the calculation of financed emissions.

The formula for the general approach to calculate financed emissions:

$$\text{Financed emissions} = \text{Emissions}_i \times (\text{Outstanding amount}_i / \text{Total asset}_i)$$

(with i = borrower or investee)

Soft landing strategy and risk management strategy in the post COVID-19 era

COVID-19 has led to substantial changes in consumer behavior and patterns of demand. On top of this, as the barriers among industries are being lowered with digital advancement, a phenomenon also known as “Big Blur”, we are expecting unprecedented changes in the financial industry. In response, Shinhan Financial Group has established an advanced system for the preemptive management of any financial risks that may occur as the world recovers from COVID-19. The risk scenarios that are being assessed include greater instability in financial systems, significant adjustments to asset prices as a result of rising interest rates, a liquidity crunch from debt deleveraging, and a shock in emerging markets from large capital outflows. In addition, we recognize the importance of non-financial strategic risk management, which is why we are setting out preemptive responses to improve our ability to adapt to the fundamental changes that will occur in the post pandemic era.

One of the biggest financial risk factors for Shinhan in 2022 is the possibility of increased volatility caused by the US monetary policy normalization. We have examined the spillover effects of the Fed’s normalization of its financial policy and assessed the associated risks and impact on the Group. In addition, based on various risk scenarios, we have selected several risk factors for our varied business segments to be managed and monitored at the Group-level. Against the backdrop of continued high interest rates, fluctuating exchange rates, and inflation in Korea, we have, at the Group level, expanded the scope of risk monitoring by identifying

different routes of financial contagion, and strengthened our risk scenario analysis to establish preemptive countermeasures.

In preparation for increased financial market volatility, we have analyzed the impact not only of absolute levels of interest rates, but also the impact of different yield curve scenarios, and incorporated our analysis to execute more flexible portfolio management schemes that are in line with interest rate sensitivity of bonds.

In order to be better prepared for a liquidity crunch, we have diversified the funding of the Group and each Group subsidiary, in terms of maturity, structure, and more. We also enhanced our liquidity emergency funding plan by operating our ALM portfolio under different scenarios in a more flexible manner.

We have increased monitoring of vulnerable borrower groups, particularly those who are most sensitive to rising interest rates and falling liquidity, and we are now focused on selective growth centered around high quality assets. In order to be ready for a potential crisis in emerging markets, we have improved liquidity management systems at overseas subsidiaries and strengthened risk management at the Group level, aimed at minimizing financial risks.

For non-financial risks, we are looking into risk factors such as acceleration of digital transformation and heightened demand for ESG management, as well as risks that may arise from some of the trends expected to emerge after the pandemic eases, such as virtual assets, intangible assets, generation gap and stratification, and organizational change. As a way to prepare ourselves for the future ahead we have created a list of risk factors and strengthened our management around them.

Shinhan Bank Delinquency Ratio by Sector

(Unit: %; Quarterly trend)

	Dec. 2020	Mar. 2021	Jun. 2021	Sep. 2021	Dec. 2021
Retail Loans	0.21	0.20	0.21	0.20	0.17
Large Corporates Loans	0.11	0.07	0.13	0.00	0.00
SME Loans	0.30	0.34	0.33	0.31	0.26

Shinhan Card Delinquency Ratio & 2M Delinquency Migration Ratio*

(Unit: %; Quarterly trend)

	Dec. 2020	Mar. 2021	Jun. 2021	Sep. 2021	Dec. 2021
Delinquency ratio (One Month)	1.04	0.96	0.85	0.89	0.80
2M delinquency migration ratio*	0.26	0.26	0.23	0.24	0.25

* 2 months delinquency migration ratio = (2 months overdue assets outstanding as of the end of base month) / (normal assets outstanding as of the end of (base month-2 months))

FEATURED
CASEShinhan Financial Group's
risk management organization and system

RISK MANAGEMENT TOOLS

RISK MANAGEMENT PHILOSOPHY

All employees of Shinhan Financial Group follow the same set of risk management guidelines that apply to every risk-related action and decision taken in front offices, thus ensuring that the fullest possible range of risks is taken into account in all our business dealings.

INTEGRATED RISK MONITORING SYSTEM

We run a comprehensive risk monitoring system that measures a wide range of outside economic indicators, our own risk indicators, and the current status of our risk management process and policies. This system enables a timely identification of potential risks and other key issues. Upon an analysis of the impacts of such risks and issues, preemptive countermeasures are put into place at the Group level. The system also detects and manages unexpected shifts within core indicators by operating a "risk dashboard" system to monitor the amount of assets, risks, and related external issues contained in the portfolios being managed by each subsidiary.

RISK EXPERT NETWORK (REN)

The REN, a network of our risk experts, was formed to foster risk experts through risk training programs and workshops, and to upgrade the overall risk management capabilities of Shinhan Financial Group. Members of the REN are chosen according to their work experience and knowledge within their business areas and the related risks. The REN performs a pivotal role in spreading a culture of strong risk management.

GROUP-WIDE CORPORATE CREDIT SCORING SYSTEM

In order to ensure the best-in-class credit risk management at all levels of our operations, all of the Group's subsidiaries are obliged to align their credit assessment system with the Group's standard corporate credit scoring system. This system, which has received an official approval from the Financial Supervisory Service in 2016, has improved the quality of our credit portfolio.

GROUP-WIDE RISK MANAGEMENT SYSTEM

We preemptively manage risk at the Group level through our seamless risk management system which identifies risks, determines the development phase of each risk, and then establishes and executes targeted countermeasures. For example, our liquidity risk management system monitors the status of liquidity management at each subsidiary in order to ensure efficient decision-making and suitable emergency measures in the event of a crisis. To respond to climate risk, we developed a system for calculating financed emissions, thereby identifying vulnerable areas with respect to climate change and supporting our "Zero Carbon Drive" strategy.

RISK MANAGEMENT ORGANIZATION

Shinhan Financial Group's risk management organization comprises of the Group Risk Management Committee, Group Risk Management Council, Group Chief Risk Officer (CRO), Risk Management Team of the holding company, and other risk-related committees and dedicated organizations within individual subsidiaries.

GROUP RISK MANAGEMENT COMMITTEE

As the highest decision-making body that establishes basic policies and strategies concerning the Group's risk management, the Committee, which is a subcommittee of the Group's Board of Directors, is composed of independent directors, and mainly deliberates and discusses the following:

1. The development of risk management policies that are in line with management strategies;
2. The determination of risk limits for the Group and its subsidiaries;
3. The approval of appropriate investment limits and risk exposures;
4. The enactment and amendment of the Group's risk management regulations and Group Risk Management Council regulations;
5. The organizational structure of the Group's risk management entities and their roles and responsibilities;
6. Matters concerning the operation of the Group's risk management system;
7. Matters concerning the setting of various limits and the issuance of approvals for exceeding limits;
8. Decision-making matters concerning FSS approvals, based on internal ratings approaches to the Group's credit evaluation system;
9. Matters concerning the Group's policies regarding risk disclosures;
10. The results of risk scenario analyses, and relevant capital management and financing plans;
11. Matters deemed necessary and appropriate by the BOD;
12. Matters demanded by outside regulations, including those of the FSC, and matters set forth in other regulations, guidelines, etc.; and
13. Other matters deemed necessary and appropriate by the Chairperson.

GROUP RISK MANAGEMENT COUNCIL

The Council discusses risk policies and strategies of the Group and each subsidiary, and makes decisions on matters necessary to the implementation of policies determined by the Group Risk Management Committee. It is composed of the Group CRO and the CROs of the Group's major subsidiaries. It mainly makes decisions on the following:

1. Matters concerning the setting of exposure limit for a country, areas that require caution, individual company and its affiliates;
2. Matters related to the analysis of the integrated crisis situation of the Group; and
3. Matters related to the Group's non-retail credit assessment system excluding those subjects to approval from the FSS.

It mainly deliberates and discusses the following:

1. Matters concerning the setting of risk tolerance of the holding company and each subsidiary;
2. Results of the analysis of the integrated crisis situation of the Group, and related matters on capital management plans and funding plans;
3. Matters related to risk disclosure policies; and
4. Other matters deemed necessary and appropriate by the Chairperson.

GROUP CHIEF RISK OFFICER

The Group Chief Risk Officer (CRO) assists the Group Risk Management Committee, implements the risk policies and strategies determined by the Committee, and ensures that they are executed consistently across all of the Group’s subsidiaries. In addition, the Group CRO evaluates each subsidiary’s CRO, and examines the status of each subsidiary’s risk management.

RISK MANAGEMENT TEAMS

The Risk Management Team of the holding company supports the Group CRO. The risk-related committees and dedicated teams within individual subsidiaries implement risk policies and strategies in line with the Group’s risk management direction, and report back to the holding company. They are also responsible for managing risks at the subsidiary level, and for making improvements to their risk management systems.

Risk Management Structure

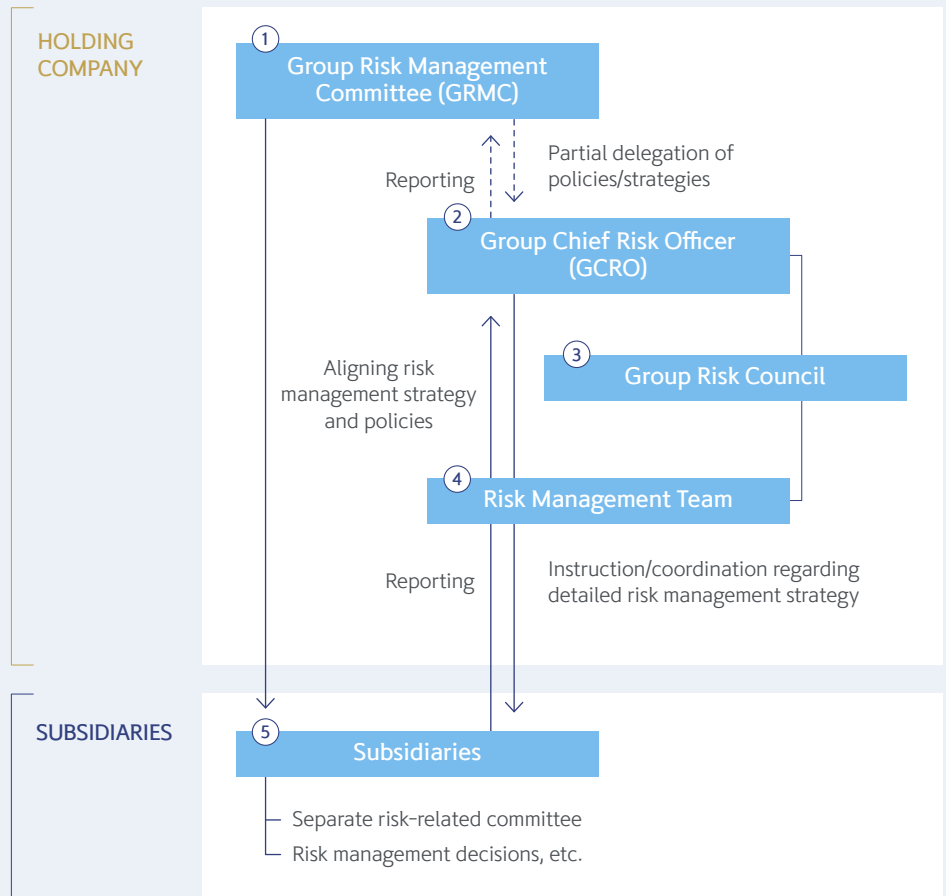

CRO's Reflections on Our Resilience

REINFORCING RISK MANAGEMENT TO ENSURE BALANCED GROWTH



Bang Dong Kwon
Chief Risk Officer, Shinhan Financial Group

We are in an era of wide-ranging and complex change. This wave of change is being led by the effects of the COVID-19 pandemic, and also by a turbocharged digital transformation which is changing how people live. In addition, stakeholder-centered ESG management, as a way to guarantee corporate sustainability, is becoming increasingly vital part of businesses.

The Group's risk management therefore seeks to break through these uncertainties as part of our commitment to "reading the nature of change and supporting the Group's balanced growth". Our risk strategy direction for 2022 is "**S.M.A.R.T.** Risk Management", to ensure that we are fully prepared for the rogue wave of increased complexity regarding the routes via which risk is spreading.

In order to respond to both the risks and the opportunities that will arise post-pandemic era, we are extending the range and depth of our scenario analysis and strengthening the relevant management support (**Scenario**). In addition, we are substantially improving the consistency, reliability, and speed of our data by upgrading the Group-level data-based risk measurement system, which in turn will allow us to make Group-level decision-making more data-based (**Measurement, Assessment**). To demonstrate greater resilience, we are managing all the key potential risks, so called a "gray rhino", in every segment of the Group's portfolio through an in-depth assessment of volatility in both financial markets and the real economy.

The spectrum of risk that we should manage is getting wider every day, which is why we are implementing new risk management initiatives in many different parts of our business.

We will also support qualitative growth by improving capital efficiency, strengthen our functions as the Group's risk management control tower, and upgrade our risk management capabilities by taking into account the industry characteristics of each Group subsidiary (**Resilience**). Furthermore, we will waste no time in strengthening our risk management system by using new digital technologies, such as artificial intelligence (AI) and machine learning, aimed at upgrading our capabilities in risk analysis and early detection of any risks (**Timely**).

The spectrum of risk that we should manage is getting wider every day, which is why we are implementing new risk management initiatives in many different parts of our business. In relation to ESG and climate change, Shinhan became the first company in the Korean financial industry to set up an Environment and Social Risk Management Policy Framework. We have also implemented a system for the calculation and management of financed emissions as part of our commitment to achieving net-zero. In addition, we have made a preemptive response to the rapid changes in the industrial landscape by increasing our ability to assess the value of intangible assets as part of a company's future value, thus more accurately reflecting the upside potential. We are also focusing on digital risks, including technological risks that may arise as the data-driven economy and businesses become more dominant, as well as on exposure to any new types of transferred risks that may be caused by having more partnerships with third parties.

There is no arguing that a great number of challenges lie ahead of us. In preparation for the opportunities and unexpected risks ahead, our risk management will focus more on scenario planning in order to identify those risks and opportunities, and then address them appropriately. No matter what uncertainties we face, we will respect all stakeholders from a long-term perspective and make utmost efforts for the Group's stable and balanced sustainable growth.

BUILDING A DIGITAL ECOSYSTEM TO ELEVATE DIGITAL COMPETITIVENESS

MAU of SFG's Main Platforms

(Unit: 10 thousand users)

- Shinhan Alpha+ I mobile
- Shinhan Card pPlay
- Shinhan Bank SOL

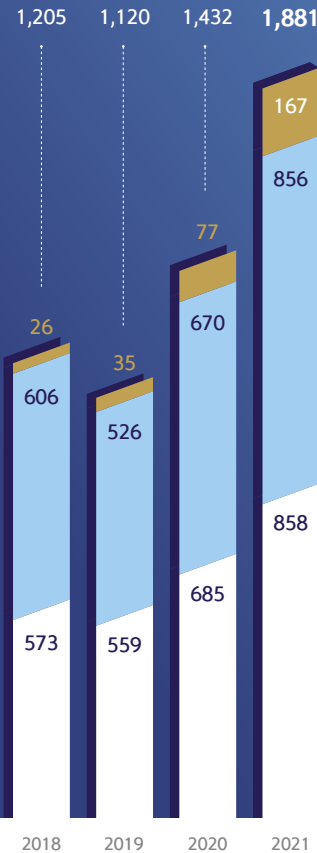

Innovating customer contact channels and accelerating the digital transformation in 2021

In 2021, major Shinhan subsidiaries, including Shinhan Bank, Shinhan Card, Shinhan Investment and Shinhan Life Insurance, increased the non-financial content on their financial platforms as a way to offer differentiated customer experiences in the digital era. As a result, the monthly active users (MAUs) of Shinhan Bank's SOL and Shinhan Card's pPlay recorded the highest level of annual growth within the industry in Korea. The MAUs of each of these platforms exceed 8.5 million, and they have successfully evolved into online destinations for customers to visit more often and stay longer.

Shinhan has been active in personalizing the services its digital platforms offer through the MyData business. Shinhan Bank and Shinhan Card have already acquired their MyData business licenses and launched services, and Shinhan Investment and Shinhan Life Insurance are planning to apply for the licenses.

Shinhan Bank's MyData service, called "Moneyverse", consists of fully personalized product recommendations, financial insights based on big data, and other asset management and financial analysis services. Moneyverse also offers the "My Calendar" function which provides a range of notifications relating to the user's financial schedules, public offerings, apartment subscriptions, and even lucky draw schedules of popular commercial products such as limited Nike sneakers. Shinhan Card provides tailored advice and recommendations for credit cards based on each user's asset base and pattern of consumption.

In addition, we are constantly adding data-driven alliances with partners across various industries, aimed at expanding financial data and converging with non-financial data. Going forward, Shinhan subsidiaries will offer distinctive services by combining data with their core businesses in banking, payments, investments and healthcare.

Shinhan’s rapid digital transformation has led to cost savings and increased operating profits, and we are increasingly incorporating digital technology in our offline operations. We continue to optimize the use of resources across our offline customer channels, with the focus being placed on greater scale and efficiency for Shinhan Bank and Shinhan Investment, and on improved productivity for Shinhan Card and Shinhan Life.

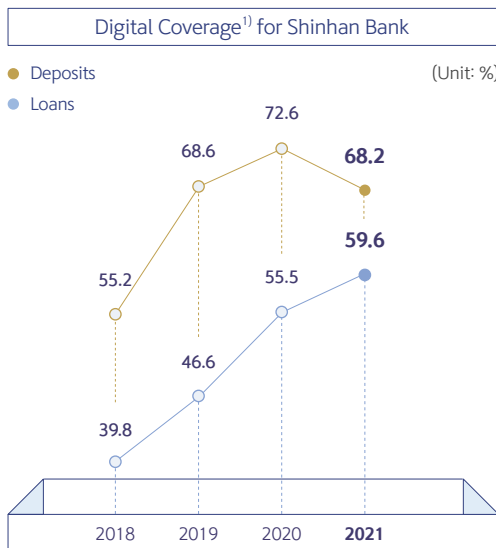

¹) Digital Coverage (%) = Number of new retail transaction via digital channels / Total number of new retail transactions

Discovering new markets and expanding products & services through new technologies

Shinhan is making innovative moves into establishing a highly competitive life-style platform that goes beyond strengthening the financial competitiveness. One leading example is “HowFit” which combines an AI-based home training platform with a motion recognition system. Healthcare will be a major source of revenue in the future, and thus Shinhan Financial Group has sought additional digital contact point with consumers of its core insurance business, which in turn led to the launch of HowFit in March 2021. The app has earned 4.5 stars in the Apple App Store and also won the grand prize as Google Play’s “2021 self-development app that lit up the world”, a clear recognition of its advanced technology and customer-focused innovation. HowFit had attracted 336,550 subscribers by the end of December 2021, and is now fully incorporated as a healthcare subsidiary of Shinhan Life Insurance, ready for a major expansion in 2022.

Shinhan Bank became the first Korean financial institution to enter the food delivery business with the launch of its “Ddaeng-gyeoyo” app. Unlike other existing platforms of its kind, Ddaeng-gyeoyo has been recognized for expanding services to the everyday lives of the financial customers, and praised for generating a win-win ecosystem for restaurant owners, consumers, and delivery riders. Such innovation is part of Shinhan’s commitment to leveraging customers’ non-financial data in order to further enhance innovation in financial services.



Shinhan’s healthcare app, “HowFit” combines AI technology with virtual home training classes

As a result, the launch of the Ddaeng-gyeoyo app in 2021 led on to the launch of the “Ddaeng-gyeoyo Business Loan” and “Ddaeng-gyeoyo Private Label Credit Card (PLCC)” in the first quarter of 2022, with installment savings products and other related financial products expected to be launched in the months to follow.

Shinhan is striving to be at the forefront of the new financial culture by introducing a range of services which leverage emerging technologies, including the metaverse. In response, Shinhan Card has signed a partnership with Zepeto, a metaverse platform in Korea, to open a virtual Shinhan Card space within Zepeto, with additional plans for launching financial products aimed specifically at the Generation Z in the near future. In addition to its alliances with external partners, Shinhan Bank is setting up its own metaverse-based, contactless communication platform named “S-Verse”. S-Verse will create a space which is open to customers at any time, and will be equipped with branches and shopping centers which offer both financial and non-financial services.

Furthermore, Shinhan is developing NFT-based platform content so that customers can store and share their belongings and experiences in a digital wallet. Shinhan Card has launched the “My NFT” service within the Shinhan pLay app, enabling its users to easily make an NFT of their favorite picture or image, as well as to send their ownership. Looking ahead, Shinhan plans to further connect and expand its platform based on new innovations such as its NFT-related services.

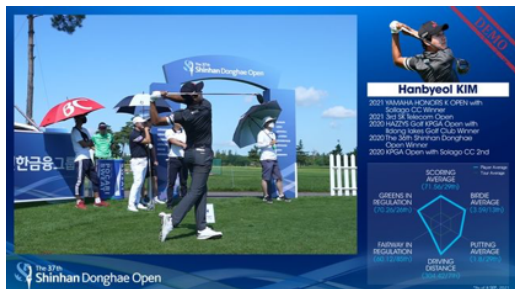

NFTs, created for the tee shot images of some 60 players who qualified for the Shinhan Donghae Open golf tournament

More investment into the digital domain and more fintech and inter-industry partnerships

Shinhan was the first company in the Korean financial industry to set up a strategic investment (SI) fund to invest in startups with emerging digital technologies. This SI fund, which amounts to KRW 300 billion in total, aims to increase traffic and transaction (T&T) of digital natives, including Millennials and Generation Z, enhance Shinhan’s capabilities in digital technology, and support digital business across the Group. As part of efforts to achieve these strategic goals, we have made a total of KRW 173 billion in investments in 11 companies as of the end of 2021. The startups we have invested in through our SI fund include a self-driving technology firm, a transaction platform for used goods targeting digital natives, style e-commerce, and other digital platforms that specialize in healthcare, used cars, blockchain, and metaverse entertainment. As a result, Shinhan became the first financial institution in Korea to launch a My NFT service which creates and inquires NFTs, launched a service to trade authenticated used cars, and offers advanced payment services and loans for e-commerce merchants.

Shinhan Financial Group plans to create a second fund in 2022 in order to increase investments and reinforce its long-term cooperation with digital startups.

With boundaries between industries becoming increasingly blurred, Shinhan is setting up strategic alliances with leading firms of different industries in order to add new customers and technologies, thereby creating new value. We have in place a business alliance with KT, Korea’s leading telecoms provider with 17 million subscribers.

This alliance covers many areas, including real estate, distribution, media infrastructure and platforms, and has resulted in multiple practical advancements, such as upgrading loan models using telecommunications data, embedding HowFit in KT’s IPTV platform, and entering other new non-financial businesses. In addition, Shinhan has acquired a strategic stake in Douzone, the leader in Korea’s ERP market, which has enabled us to go beyond the simple integration of services. The strategic investment allowed us to cooperate with Douzone to launch brand new corporate banking services from the Banking-as-a-Service (BaaS) perspective. We have greatly improved the convenience of corporate clients by enabling them to open a Douzone-Shinhan SolBiz corporate account without having to visit an offline branch. Such procedural innovation was made possible thanks to a real-time access to corporate data on the Douzone ERP platform, which boasts of having the largest amount of data of SMEs in Korea. Going forward, we will continue to identify and solve our client’s pain points and holistically innovate and improve the customer experience of our digital corporate banking services.

Launched in 2015, Shinhan Future's Lab is a startup accelerator program, the first of its kind in the Korea's financial industry, and has been a great success in expanding mutually beneficial cooperation with startups.

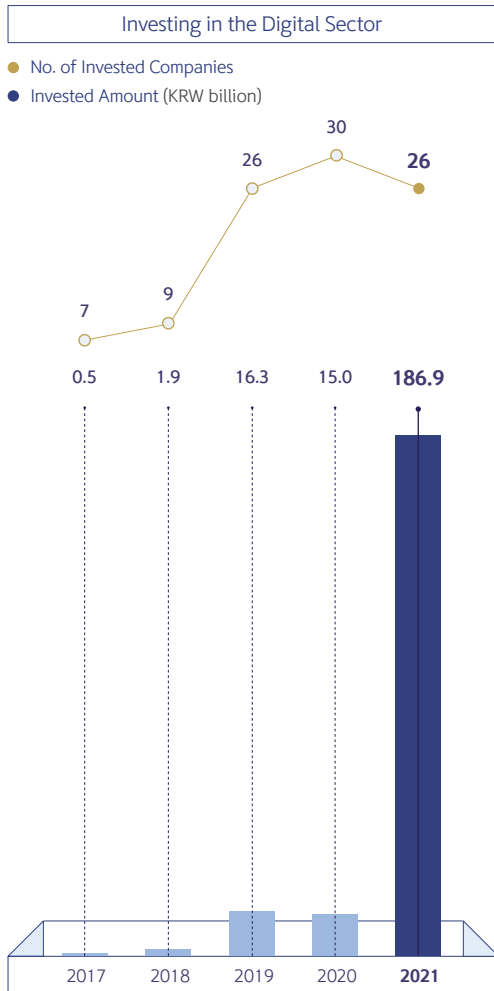

As of the end of 2021, we had supported 282 startups with a total investment of KRW 59.5 billion. Of the member companies, 10 were designated as baby unicorns in the Baby Unicorn 200 project of the Ministry of SMEs and Startups, the most of any startup accelerator in the financial industry. Such endeavors are not only limited to Korea. Shinhan is also striving to find and support local startups in our overseas strategic markets, including Vietnam and Indonesia, so that we can accelerate the Group's digital transformation and generate cross-border cooperation between innovative startups in different countries.

Attracting and nurturing the best in digital talent, and strengthening in-house capabilities in new technologies

Shinhan defines the ideal digital talent as "creating value through an understanding of core businesses and digital technologies", and operates Group-wide digital initiatives in support of this. We nurture experts in fields right across technology and digital business, and we are also enhancing the overall digital literacy of the Group. "SCOOL", the Group's digital training platform which stands for "Shinhan Collective Open Online Learning", uses technology to offer a wide range of studies, at levels from beginner to advanced. As of the end of 2021, a cumulative 10,000 employees had completed SCOOL digital training courses, thus playing a significant role in the Group's digital transformation. Shinhan is also enhancing its digital expertise through a number of programs which are either Group-level or subsidiary-specific, including a master's degree program in digital financial engineering at Korea University, the BD 1000

Project aimed at developing 1,000 big data analysts at Shinhan Bank, and a program to nurture experts in data science at Shinhan Card.

Shinhan strives not only to develop digital talent in-house, but also to recruit from outside. To this end, we introduced year-round recruiting system for digital and ICT talent for the first time in the Korea's financial industry, while also expanding our recruiting criteria for new hires, experienced staff, and holders of masters and PhD degrees. We also recruit from top-tier institutions such as Samsung Software Academy for Youth and Korea Advanced Institute of Science and Technology (KAIST). In addition, we are speeding up the recruitment of the best people in ABCD (AI, Blockchain, Cloud, Data) digital innovation. For example, we make full use of external recruiting platforms such as LinkedIn in order to target the recruitment of digital and technology experts. This can shorten the traditional recruiting time by one to two months and more accurately pinpoint the relevant candidates, thus enabling Shinhan to respond proactively to the need for digital talent.

Putting ESG into practice through digital services and technology

As digital transformation accelerates, some members of our society, especially the elderly, are left behind. As part of our efforts to bridge the digital divide for an inclusive digital economy, Shinhan Financial Group offers digital services tailored to senior citizens and others who are digitally marginalized. One example of this is a special ATM service that was launched in 2021 for senior customers who struggle with small fonts and complex financial terminology, and who therefore prefer to visiting bank counters even for simple transactions. By leveraging the results of our big data analysis, the four most frequently used ATM menus were positioned upfront in the most visible space, and in easy-to-understand, intuitive language. Following increased ATM utilization at branches which participated in the pilot project, and positive feedback on social media, this service is now being rolled out right across our branches.

Shinhan Bank selected one branch with a particularly high ratio of senior customers using bank counters for simple tasks, and converted it into a digital innovation branch with a layout aimed at better accommodating of customers both through design and by leveraging digital devices – different tasks were color-coded, and digital devices and lines on the branch floor were painted accordingly, so that customers could easily find the relevant counters. Smart ATM kiosks that had previously been installed outside the branch were moved inside to make them more usable for senior customers.

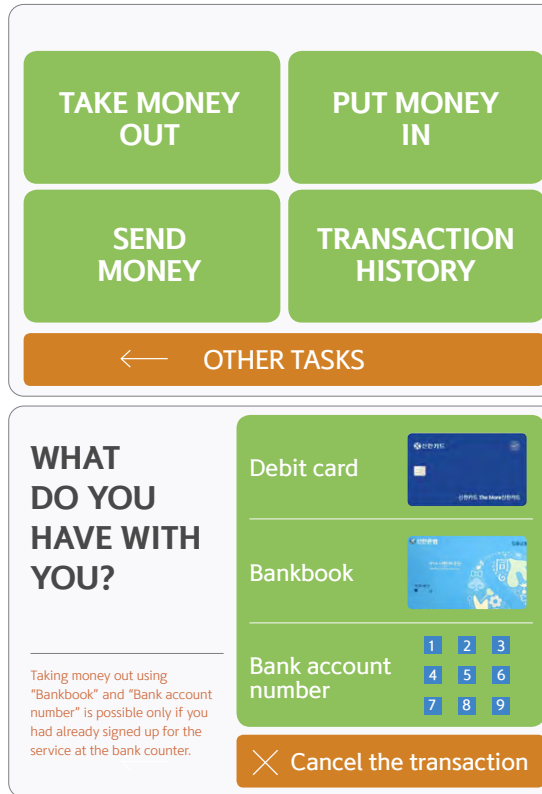

ATM screen tailored to senior customers



Digilog Branch, a testbed for the space of future financial services

Moving forward, we will continue to use data-driven analysis to improve the customer experience for senior citizens. We will also ensure that senior customers are not marginalized from the benefits of digital finance by offering both online and offline digital literacy education.

Shinhan is fully committed to supporting SMEs. Our food delivery app, “Ddaeng-gyeoyo”, waives onboarding and advertising fees for franchisees, and has the lowest brokerage fees in the industry, in our pursuit of win-win cooperation with small business owners. In addition, we are supporting delivery riders suffering financially from having a very limited credit history by collecting and analyzing delivery data and rolling out a micro-loan product exclusively for riders. In addition, we have recently started to analyze sales data from franchisees so that we can develop products specifically for business owners. This will enable us to create a mutually beneficial open platform based on the non-financial data of customers, franchisees and riders.

CDO's Reflections on Our Ecosystem

ELEVATING OUR STRENGTH TO DRIVE DIGITAL INNOVATION

**Kim Myoung Hee**

Chief Digital Officer, Shinhan Financial Group

Please tell us about Shinhan's digital vision and strategy

In order to put our new corporate vision, “We believe finance should be More Friendly, More Secure, More Creative”, into practice, we have set out the three pillars of our digital goal – data-driven innovation for a better customer experience (more friendly finance), reinforcing and protecting the rights of customers (more secure finance), and expanding new businesses for enhanced customer services and joint growth (more creative finance). For a more friendly finance, we focus on strengthening customer engagement by using data in order to improve and better manage the customer journey. For a more secure finance, we are fully committed to handling customer data in a completely secure manner. We are also committed to providing customers with safe and reliable finance and to provide inclusive digital finance. Last but not least, we will make our finance more creative by making inroads into new markets, exceeding customer expectations, and growing in partnership with our customers.

In a bid to achieve these three goals, we will upgrade our data governance and improve three core areas of Shinhan's digital transformation – technology, processes and organization. Above all, our customers will be at the center of our digital transformation, which will be driven by Shinhan's own unique characteristics with sincerity and consistency.

With the utilization of massive amounts of financial data becoming important, what is Shinhan's strategy for making use of this data?

Shinhan is both maximizing the use of data acquired across different subsidiaries of Shinhan Financial Group to generate One Shinhan synergy while making sure that all our businesses stay up to date with changes in data-related regulations. Korean financial authorities have overhauled policies aimed at protecting financial consumer's privacy and promoting data industry, and introduced MyData licenses. Shinhan Bank and Shinhan Card have acquired MyData licenses and launched related businesses, while Shinhan Investment and Shinhan Life Insurance are currently applying for the license. Going forward, we plan to launch distinctive services by integrating data with our core businesses of banking, payments, investments and healthcare.

In addition, Shinhan is responding to the greater use of data by setting up an advanced data governance system and building a Group-wide data dam. We are also establishing an integrated and standardized data utilization system and creating a Group-wide data strategy platform, with the goal of enhancing customer value by offering tailored services and increasing synergy across the Group.

We will upgrade our performance management systems to measure digital value more accurately, thereby managing our digital transformation as efficiently as possible and communicating with the market in a fully transparent way.

How do you expect Shinhan's digital transformation to affect its business model over the medium- to long-term?

The digitalization of the financial industry is having a radical effect on how a financial company is valued. The focus is increasingly moving away from being capital-based towards an emphasis on measuring the number of digital customers, such as MAU. Shinhan already has an active customer base of 19.5 million, representing approximately 68% of Korea's economically active population. We are dedicated to offering the highest levels of customer experience, based on our financial know-how, financial and non-financial (behavioral) data accumulated from both within and outside the Group, and our competitiveness in customer engagement. We will create our own distinctive value over the mid-to long-term by integrating our traditional, capital-intensive financial businesses with the capital-light platform business. In addition, we will upgrade our performance management systems to measure digital value more accurately, thereby managing our digital transformation as efficiently as possible and communicating with the market in a fully transparent way.

TAKING ACTION FOR A MORE SUSTAINABLE FUTURE

Shinhan's ESG Strategy Framework

Mission



Mid-term Goal

EXCELLENCE SHINHAN

ESG Principle

FINANCE for IMPACT

Vision

+ More Friendly, Secure, Creative

Mid-term Goal

F.R.E.S.H 2020S

ESG Slogan

Do the RIGHT Thing for a wonderful World

Strategic Directions

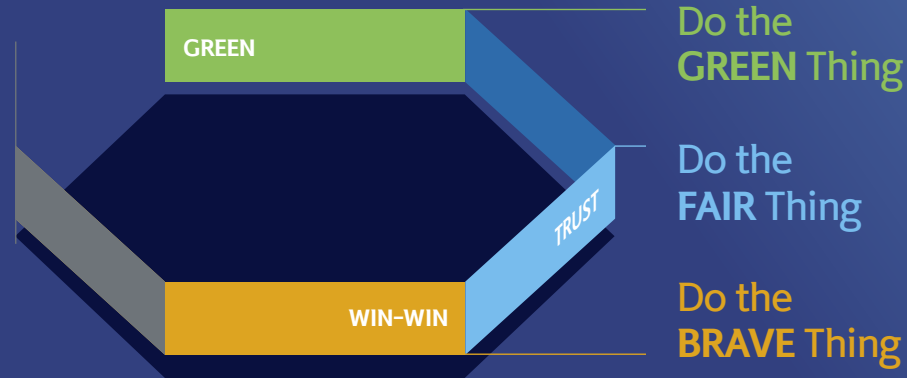

Do the Right Thing for a Wonderful World

Companies around the world agree that creating environmental, social, and governance (ESG) value is essential for sustainable corporate growth. Most ESG issues are difficult to resolve over the short-term, and require concerted efforts and collective action, which makes effective communications absolutely vital. Accordingly, many global companies have established their own ESG brand, and are striving to improve communications with their stakeholders.

Shinhan Financial Group created its ESG brand slogan in September 2021, “Do the Right Thing for a Wonderful World”, setting its ESG standard as “Is this the right thing?” and embodying its determination to “Do the Right Thing” to create a “Wonderful World” which is a destination of Shinhan’s ESG Way. “Do the Right Thing” is supported by efforts to reduce carbon emissions in order to “Do the Green Thing”, helping startups to “Do the Brave Thing”, and supporting equal opportunities and shared growth to “Do the Fair Thing”.

This ESG brand slogan demonstrates Shinhan Financial Group’s ESG strategy and implementation policies, and it is aligned with “FINANCE for IMPACT”, an ESG principle which refers to Shinhan’s efforts to maximize the positive impact of finance, based on which we have set out three strategic directions – Green, Win-win, and Trust. This redefines Shinhan’s ESG management from the customers’ perspective and aims to communicate our ESG message to customers in an easy-to-understand way, thus forming a consensus on how finance can make positive changes in our society.

Environmental

From Pledge to Action

In 2020, Shinhan Financial Group became the first financial company in East Asia to officially announce net-zero commitments for both our own carbon emissions as well as the financed emissions. Under “Zero Carbon Drive”, we have set ambitious, measurable goals aimed at achieving net-zero by 2050 through carbon reduction efforts of internal and financed emissions, coupled with carbon-offsetting and green financings.

We are increasing loan support for companies with eco-friendly technology, capital investments into renewable energy, and financial support for eco-friendly facilities for our corporate clients. In green finance¹⁾, we have provided a total of KRW 2.69 trillion, exceeding the 2021 target set out in our Green Financing Roadmap for the year with 122% achievement rate.

In order to ensure the systematic management of financed emissions within our asset portfolio, Shinhan measures carbon emissions based on PCAF Guidelines, and uses SBTi methodology to set specific reduction goals. As of the end of 2020, we had measured 43.8 million tCO₂e in financed emissions from KRW 212.3 trillion of the Group financial assets, which was followed by the goal setting of 33.7% reduction by 2030 and 59.5% by 2040. Beginning from 2022, green finance and the reduction of carbon emissions has been included as part of KPIs for Group subsidiaries to ensure that real action is taken.

Zero Carbon Drive is Shinhan’s eco-friendly growth strategy which will drive our successful transition to a green economy. Shinhan is paving the way to a low carbon transition through finance and is making efforts to further widen the path.



We also made pragmatic systemic upgrades to achieve our net-zero targets. In 2021, Shinhan developed a financed emissions measurement system that allows each subsidiary to calculate emissions information of a portfolio company and conduct simulations.

We launched a project to establish a “Group ESG Integrated Risk Management System. At the same time, we have created an “ESG rating” which encourages borrowers and investment companies to improve their ESG management, inducing and leading our corporate clients towards ESG management.

We also accelerated our engagement activities to drive faster change in partnership with our clients. In October 2020, we sent a letter to 242 investment target companies, calling on them to take an interest in climate change and to make climate disclosures in compliance with TCFD recommendations. We sent similar letters to 338 companies in 2021, and 146 companies replied by joining Shinhan’s commitment to net-zero.

In addition, Shinhan Bank newly launched the “ESG Consulting Cell” in 2022, which will work toward sharing its ESG expertise with its SME clients. These efforts will stimulate ESG management at our invested companies while also supporting the eco-transition of our corporate clients.

¹⁾ The figures for our green finance results are in line with the Green Bond Principles (GBP) of the International Capital Market Association (ICMA). The figures will be reclassified and reassessed in accordance with K-Taxonomy, once available.

Social

Hope Together SFG

In order to put the Group mission of “Compassionate Finance, Your Companion for the Future” into practice, Shinhan Financial Group has made an annual investment of KRW 90 billion in the Hope Society Project every year since 2017.

In 2021, we used the Shinhan Social Value Measurement Framework (SVMF) to measure the impact of the Hope Society Project for the three years from 2018 to 2020. The results indicated that total input of KRW 46.5 billion generated KRW 140.2 billion in social added value, creating a Social Return On Investment (SROI) of 305%. The social value of the Project was measured by classifying and measuring social savings, social value-added, outcome, influence and others, categorized from the perspective of the beneficiaries and measured using the SVMF framework. We were thus able to arrive at the objective, quantitative conclusion that the resources being invested are directly connected to the creation of social added value and improvements in life in each area, and are making a positive impact. Following this success, we will adopt SVMF for all our CSR programs. Moving forward, we will measure the social value of these programs as well as their financial and quantitative outcomes, thereby increasing the effectiveness and sustainability of our social contribution programs.

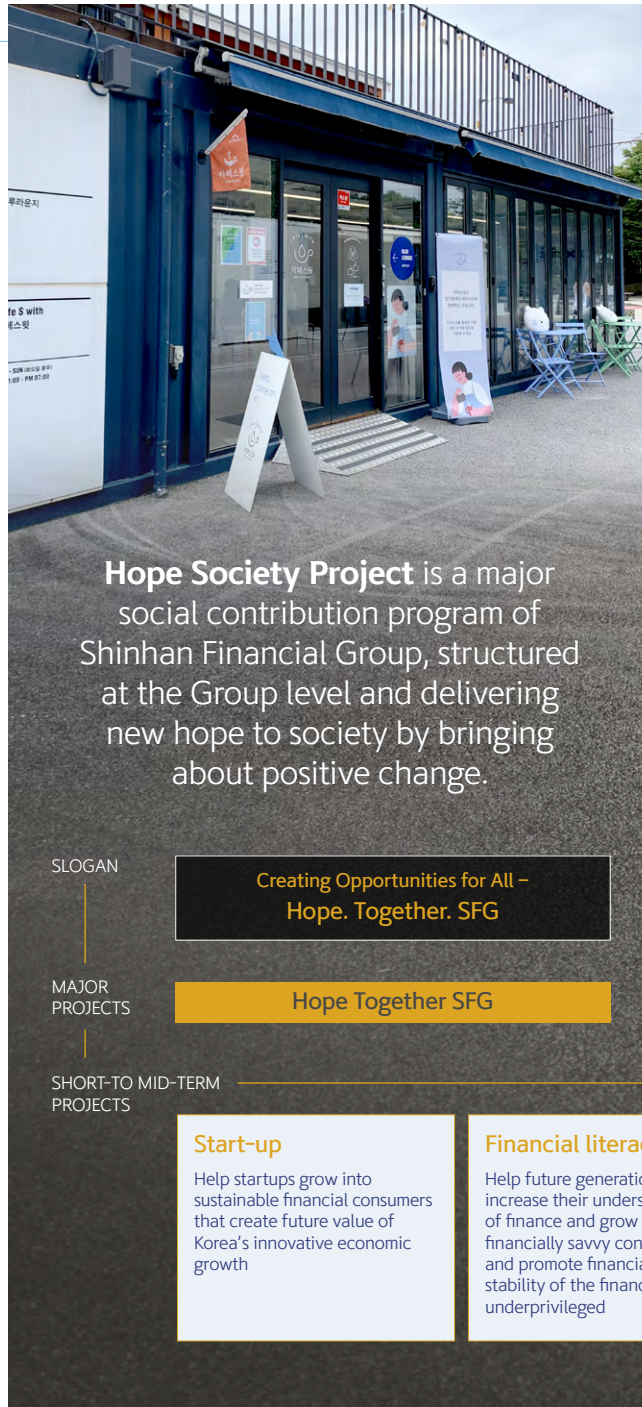

Hope Society Project is a major social contribution program of Shinhan Financial Group, structured at the Group level and delivering new hope to society by bringing about positive change.

SLOGAN

Creating Opportunities for All –
Hope. Together. SFG

MAJOR PROJECTS

Hope Together SFG

SHORT-TO MID-TERM PROJECTS

Start-up
Help startups grow into sustainable financial consumers that create future value of Korea’s innovative economic growth

Financial literacy
Help future generations increase their understanding of finance and grow into financially savvy consumers, and promote financial stability of the financially underprivileged

Group of community
Build a future development foundation that contributes to the social, economic value of the local community and its members

VERIFY EFFECTIVENESS

Analyze program effectiveness through Shinhan SVMF-based social value measurement

SFG Hope Foundation
2020 Corporate Social Responsibility Report



START-UP Shinhan Financial Group is a leading investor in startups and has been at the heart of the creation of an innovative growth ecosystem in Korea. In 2015, Shinhan became the first organization in the Korean financial sector to launch a fintech startup accelerator program “Shinhan Future’s Lab”, based on which we have been building long-term win-win relationships with globally competitive startups. Shinhan’s platform for supporting startups, “S² Bridge”, which is pronounced as “S-squared Bridge”, expanded its contact points in 2021, and is now a vital part of the startup ecosystem. S² Bridge has offline bases across Korea, including in Seoul, Incheon, Daejeon, Daegu, Gwangju, Busan and Jeju, and is supporting innovation within local economies. It also established a base in Vietnam which is supporting local startups and helping Korean startups establish a presence in that country.

Startups have infinite potential. We have established a system that supports the entire business cycle, from the very earliest days of a startup right through to its successful development. We are also creating sales channels and other cooperative systems which will help startups to make inroads into global markets, in order to support S² Bridge member companies so that they can produce a J-shaped growth curve and thus to amplify social value.

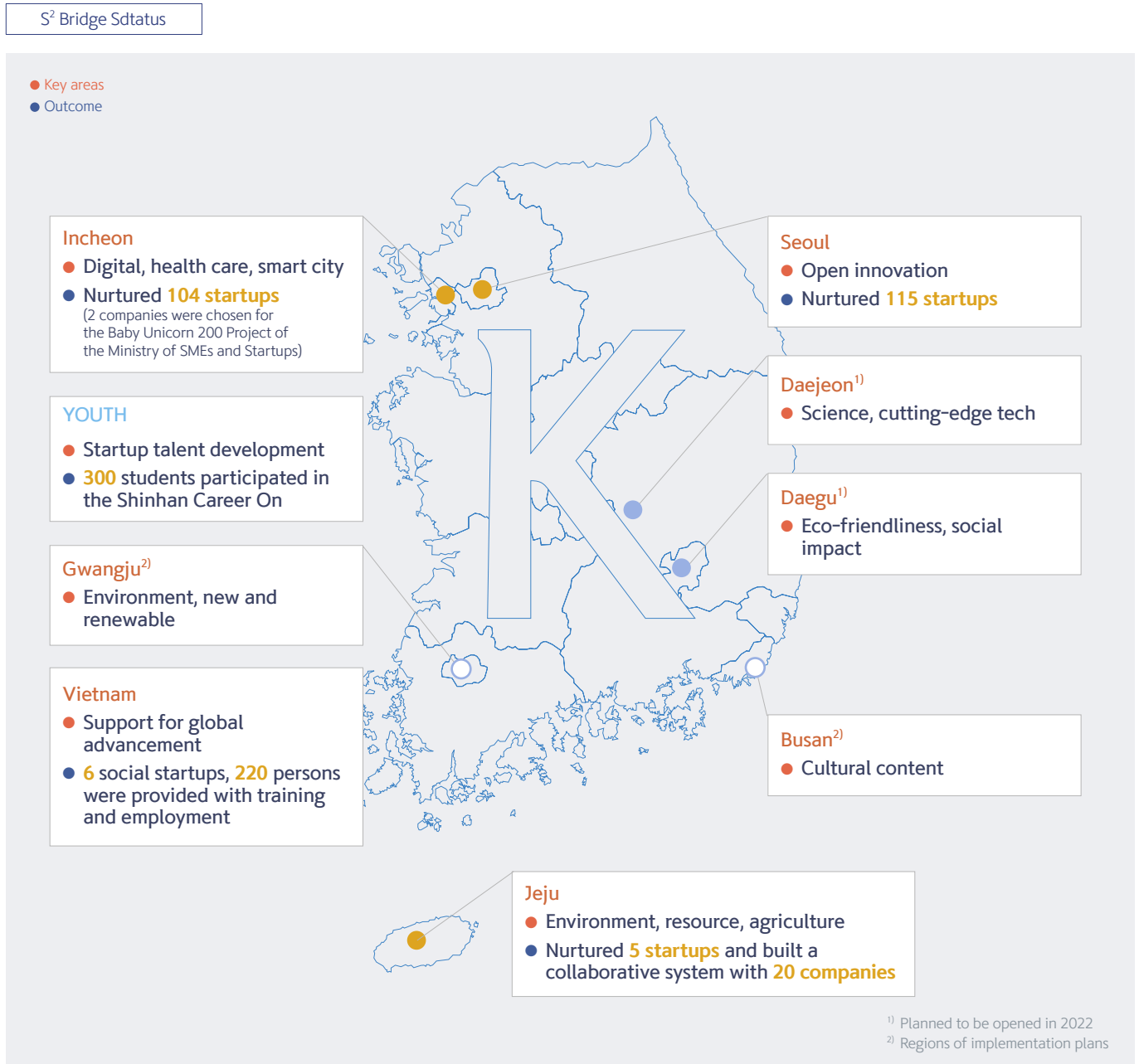

FINANCIAL LITERACY Shinhan runs a wide range of programs to help future generations of financial consumers to improve their understanding of finance. We also offer such social support to the underprivileged as employment education and skills development programs. In addition, Shinhan runs a program for young people aimed at improving their debt/credit status and increasing opportunities for employment; a project to build stable child-raising environment for double-income families; and a range of IT and software education support programs. In particular, the “Shinhan Easy” financial education platform brings together the capabilities of the Group subsidiaries in our efforts to help every generation in Korea have easy access to financial education.

GROUP OF COMMUNITY Shinhan Financial Group runs a wide range of programs to increase the social and economic value of local communities. We create jobs within our communities by strengthening our connections with companies which make a social impact, including social enterprises and cooperatives, setting a new standard for a model of social contributions through which local issues are assessed by local community members, and all stakeholders work together to solve any problems. In particular, we have worked in unison with local communities and stakeholder organizations to resolve environmental issues which have emerged during the COVID-19 pandemic. We also built an emergency support system for individuals who have suffered problems caused by prolonged quarantine measures.

In 2022, Shinhan will continue with its efforts to enable everyone to enjoy a healthy and stable life. We will increase our financial support for local communities and companies, and will give extra help to people who have thus far been unable to benefit from finance. In addition, we will focus on highly effective activities which generate the greatest possible social value, as measured by the SVMF.



Financial Education Platform

Launched “Shinhan Easy”, an integrated financial education platform of all Group subsidiaries



Youth Debt Total Care

The 3rd Youth Debt Total Care class supported 491 persons, through which 309 persons improved their credit score, 15 persons fully paid back their tuition loans



Shinhan Childcare Center

Provided childcare support by establishing 22 new childcare centers (cumulative 101 centers)



Overseas Employment of Youths, Global Young Challenger

The 3rd Global Young Challenger program supported 46 persons, and received the Minister of Employment and Labor Award for Job Creation in 2021



Job Support Program for the Disabled

Opened the second and third branch of “Cafe S-With”, and provided job support to around 20 persons with hearing impairments



Hope School Software Class

Software education provided to disabled students attending special schools: Education provided to 56 schools (cumulative 113 schools), 1,489 persons and a software contest jointly held with the Ministry of Education

“Shinhan Easy”, a financial education platform for all



Governance

ESG Governance & Organization

In 2015, Shinhan became the first financial holding company in Korea to create the CSR Committee (currently ESG Strategy Committee), a BOD sub-committee, to manage and supervise ESG at the BOD level. Starting in 2019, Shinhan appointed the Chief Strategy and Sustainability Officer (CSSO), an executive in charge of strategies and sustainability, at all Group subsidiaries and assigned working-level ESG employees to strategy departments to implement unified ESG strategies. In 2021, we created an ESG Implementation Committee consisting of the CEOs of all Group subsidiaries as a way to strengthen the driving force of the Group's ESG strategies.

After establishing a driving system in the decision-making phase, we strengthened working-level capabilities through organizational restructuring. An ESG Planning Team, which is a dedicated ESG organization, was created at Shinhan Financial Group in 2021, followed by the establishment of a dedicated ESG organization at major Group subsidiaries, including Shinhan Bank, Shinhan Card, Shinhan Investment, and Shinhan Life Insurance, completing the main elements of a bigger picture for our ESG driving system.

In early 2022, we expanded the scope of our ESG management, which had previously focused mainly on strategy and planning, to include investment and sales by setting up dedicated ESG organizations within

Shinhan Financial Group has always put ESG at the heart of its management strategy, and our **ESG driving system** continues to evolve for efficient and effective ESG actions with sincerity.

Shinhan's ESG Driving System



our unique matrix system, not under the direct charge of the CSSO. In addition, we created the “Green IB Execution Lab” within the GIB business unit. The Lab is in charge of all ESG-related investments, including the research and establishing of ESG investment strategies, as well as its usual front-line sales activities. In addition, an “ESG Global Desk” has been created as part of the Global business unit in order to identify and support new climate-related businesses and potential GIB collaborations overseas. “ESG Consulting Cell” was created at Shinhan Bank to help SMEs that have recognized the importance of ESG management but are experiencing limitations in their material and human resources. All of these new dedicated ESG teams are driving forward the evolution of Shinhan's ESG driving system.

FEATURED CASE

GLOBAL INITIATIVES



Joined in October 2021

- Net-Zero Insurance Alliance (NZIA)

Joined in July 2021

- Net Zero Asset Managers Initiative (NZAMI)

Joined in April 2021

- Net-Zero Banking Alliance (NZBA)



Joined in March 2021

- Value Balancing Alliance (VBA)



Joined in November 2020

- Science Based Target initiative (SBTi)



Joined in November 2020

- Partnership for Carbon Accounting Financials (PCAF)



Joined in September 2020

- Equator Principles



Joined in February 2020

- UNEP FI Principles for Sustainable Insurance (PSI)



Joined in September 2019

- UNEP FI Principles for Responsible Banking (PRB)



Joined in September 2018

- Task Force on Climate-related Financial Disclosures (TCFD)



Joined in May 2008

- UN Global Compact (UNGC)



Joined in May 2008

- UN Environmental Programme Finance Initiative (UNEP FI)



Joined in March 2007

- Carbon Disclosure Project (CDP)

ESG EVALUATION & AWARD

Global

<p>DJI Included in DJSI World for 9 consecutive years</p>	<p>CDP Leadership A- (8 consecutive years, Platinum Club)</p>	<p>MSCI ESG Ratings AA</p>
<p>ISS Quality Score Grade:1</p>	<p>Bloomberg GEI Included in the BGEI for 4 consecutive years</p>	

Korea

<p>KCGS A+ (Overall A+ grade for 7 consecutive years)</p>	<p>Sustainvest AA (3 consecutive years)</p>
---------------------------------------------------------------	-------------------------------------------------

* As of March 2022

- First in Korea or Korea's financial industry

CSSO's Reflections on Our Sustainability

SCALING OUR WONDERFUL IMPACT BY DOING THE RIGHT THING

**Koh Seogheon**

Chief Strategy & Sustainability Officer, Shinhan Financial Group

ESG management at Shinhan Financial Group - how is it different, and why is it strong?

Finance is at the heart of the flow of funds within a country. Finance can have a major impact on our society and industry, and shape the world we live in. The ESG strategy of a financial company therefore must be more rigorous than that of an industrial company. The guiding ESG principle for Shinhan Financial Group is "FINANCE for IMPACT" which we define as maximizing the "positive impact of finance which changes stakeholders". We are focusing on five major IMPACT tasks connected to our business. Our first focus is on leading the green finance through our Zero Carbon Drive. Second, going beyond our usual role providing financial support, while also strengthening our capability in corporate screening, we are leveraging the Triple-K Project to facilitate transaction with unicorn companies through non-financial support. Third, we are helping the financially underprivileged through Hope Together SFG project. Our fourth and fifth focus areas are pursuing diversity while increasing creativity and productivity, and protecting financial consumers at all costs. In summary, Shinhan's ESG does not lead to reduced profits, rather it is a challenging but essential part of business, that leads to securing more customers, helping them grow, and making the company grow as well over the long term.

Please tell us about Shinhan Financial Group on the global stage in 2021.

Shinhan has joined various global initiatives and has been gaining experience in collaborating with the global community. We are a founding signatory of the Net-Zero Banking Alliance (NZBA) established under UNEP FI leadership in April 2021 for COP26. Further solidifying our net-zero resolve, we became the first in Korea to join the Net-Zero Insurance Alliance (NZIA) and Net-Zero Asset Management Initiative (NZAMI). In November, Shinhan was invited to the 2021 United Nations Climate Change Conference (COP26) in Glasgow as a representative of private financial companies in Asia, where we shared our thoughts on the role of finance in responding to the climate crisis, outlined our Zero Carbon Drive, and encouraged the global community to continue the fight against climate change.

In December, Shinhan Financial Group CEO Cho Yong-byoung became the only individual from Asia to be elected to a seat in the UNEP FI Leadership Council, a newly launched high-level advisory body composed of CEOs of financial institutions to provide vision and strategic direction to UNEP FI and its members in fulfilling their responsibilities regarding environmental issues. As I also serve at UNEP FI's Global Steering Committee as the Asia Pacific Banking Sector Representative, Shinhan will deepen sustainability integration across our business sectors in line with the global standards, and will work towards mainstreaming ESG within the region.

Until now, our focus has been on establishing mid- to long-term ESG strategies centered on the holding company. Starting in 2022, however, we will widen our ESG to include the Group subsidiaries which actually undertake our business.

What plans do you have for Shinhan Financial Group's ESG in 2022?

Until now, our focus has been on establishing mid- to long-term ESG strategies centered on the holding company. Starting in 2022, however, we will widen our ESG to include the Group subsidiaries which actually undertake our business. This is our ESG strategy for the year, so called "2022 Shinhan ESG – Right, Nimble, Different", with four major directions of implementation. First, we will strengthen our ESG driving system by improving our ESG governance. Measures to strengthening our ESG driving system include establishing dedicated ESG organizations and a BOD sub-committee, and making ESG strategic KPIs a key part of subsidiary evaluations. Second, we will expand K-Taxonomy-based green finance and make further advancements in our ESG analysis-based loan and investment evaluation systems. In turn, we will aim to secure net-zero execution capabilities throughout our businesses. Third, we will exploit new ESG market opportunities by increasing ESG investments and rewarding companies which are outstanding in areas of ESG. And fourth, we will be active participants in identifying new ESG agenda, thereby strengthening Shinhan's role as a representative of Asian financial companies.

VERSATILE AND TALENTED PEOPLE TO LEAD FUTURE GROWTH

No. of Shinhan SHeroes Participants

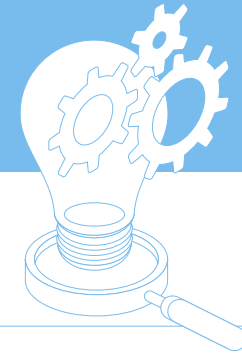
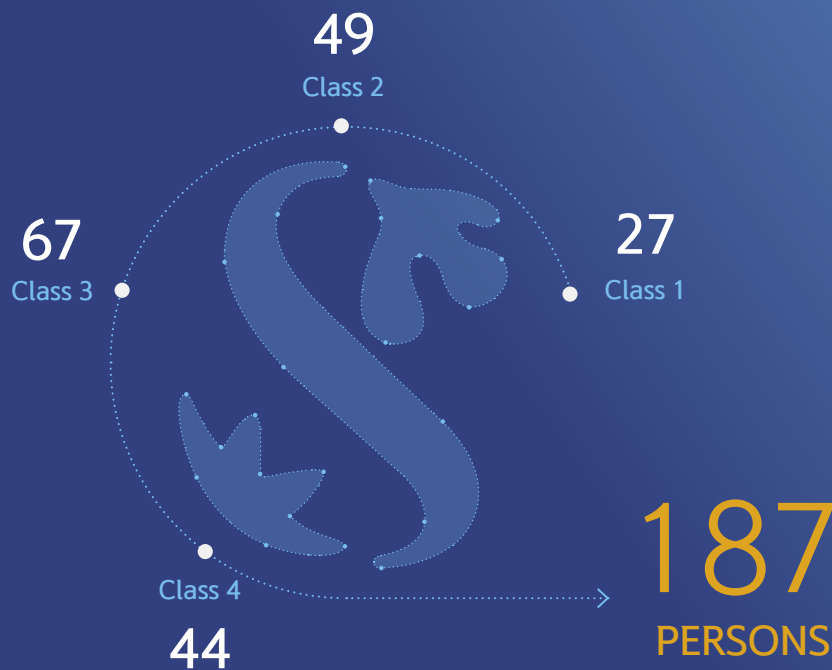

A diverse and inclusive workplace for all our employees

Shinhan Financial Group strives to create a corporate culture where no employee feels her/his capabilities overlooked or fails to seize given opportunities due to their gender, age, disability, or any other reasons. Our organizational culture that encourages all employees to voice their opinions contributes to generating dynamic synergy, which in turn creates new business opportunities and leads to better performance.

As part of these endeavors, Shinhan Financial Group is nurturing female leaders to bridge the gender gap in the management. Since the launch of “Shinhan SHeroes”, a program to nurture female talent, first of its kind in the Korean financial industry set up in 2018, focused efforts have been under way to foster female leaders in a well-structured way. Begun with 27 participants for its first class, the Shinhan SHeroes continues to identify female leaders, support them as they share their vision of growth for themselves and the Group, and run programs to nurture them as leaders. Shinhan SHeroes has been successful in its aim of developing more female leaders and creating role models with extensive experience and outstanding leadership skills, and is now increasing the size of its leadership group while also diversifying the regions and job positions targeted. 187 female talents have been chosen as Shinhan SHeroes so far, including 44 for the fourth class launched in 2021.

Shinhan SHeroes enables Shinhan’s outstanding female employees to expand their networks and share different points of views, contributing to sharpening competitive edge not only of individual employees, but also the company as a whole.

A number of programs are in place as part of Shinhan SHeroes, including expert-led leadership coaching, group mentoring, a platform for distance learning, and an active SHeroes alumni community. The lessons learned from these programs are shared at an annual Shinhan SHeroes conference held each November.

Shinhan is also doing its utmost to establish a corporate culture which supports a work-life balance and encourages female employees to chart a clear career path. The Group subsidiaries are being certified as family-friendly places to work thanks to our family-oriented programs including, among others, block leave of more than five consecutive days and paternity leave for male employees. As a result of these efforts, Shinhan Financial Group has been included in the Bloomberg Gender-Equality Index (GEI) for four years in a row since its first inclusion in 2019 for the first time in Korea.

In our efforts to bridge the generation gap within the organization, and to integrate a wide range of opinions in our decision-making processes, Shinhan has established the "Who-friend Committee", consisting of employees in their 20's and 30's, so called Millennials and Generation Z, and expanded opportunities for them to participate in critical decisions such as setting out the Group's mission and core values. The name "Who-friend" refers to the young generations who are capable of becoming a friend to whoever, and it aims to reflect the Group's commitment to creating a corporate culture of open communications without barriers. In addition, Shinhan is running a "Reverse Mentoring" system whereby members of the younger generations mentor executives to improve the way reports are made and meetings are conducted, sharing their ideas on the ideal way of working.

Shinhan Financial Group has a dedicated organization in charge of creating a corporate culture of diversity and inclusion. This includes HR policies which ensure gender equality and support work-life balance, fairer reporting systems, and improvements at subsidiary level. In addition, a number of internal organizations and policies are in place to prevent any form of discriminatory acts, including the Sexual Harassment Prevention Committee, the Workplace Bullying Prevention Committee, the Ombudsman and Grievance Settlement Process, and the Employee Happiness Center. In 2021, Shinhan set out its "Commitment to Diversity and Inclusion", thus embodying our commitment to the values of diversity.

Bloomberg GEI



Included in Bloomberg GEI for four years in a row

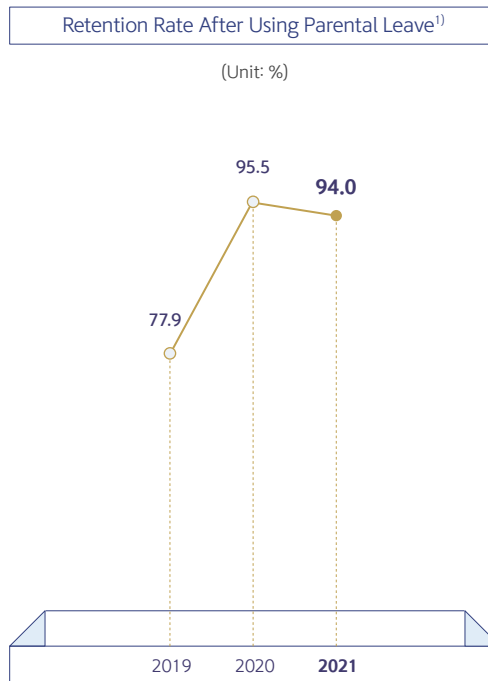

¹⁾ Data was updated to reflect OrangeLife's incorporation into the Group in 2019



Who-friend Committee

Shinhan Financial Group's Commitment to Diversity and Inclusion



A total “RE:Boot” of corporate culture

In 2021, Shinhan Financial Group launched its “RE:Boot Shinhan” project, aimed at supporting the company’s progress towards being a leading digital finance group by completely overhauling and upgrading the corporate culture. This strategy will set out a clear corporate direction, and establish efficient and effective systems for executing that strategy. Corporate culture is a major driving force in propelling the Group forward to generate exponential growth. That is why Shinhan Financial Group is now re-interpreting the tradition of the Shinhan culture, which has been in place since the founding of the Group, in order to meet the expectations of the digital era. The RE:Boot Shinhan project is improving the culture from the perspective of customers, employees and markets, and is ensuring that the Group is ready for the future.

In 2021, Shinhan set out a new vision for the Group and rebuilt the core values and standards to which all Shinhan employees must adhere. The new core values, as elucidated in “Shinhan Way 2.0”, are set out in easy-to-understand, intuitive language, and have been shared via multiple channels both in Korea and overseas, which has enabled Shinhan employees around the world to understand and act upon these essential principles.

Celebrating the launch of “RE:Boot Shinhan” project



RE:BOOT!

Core Value



RIGHT

We value doing **what is RIGHT** for our customers and for the future generations.



NIMBLE

We value being **NIMBLE** – executing with flexibility and efficiency, never stop learning and **keep moving forward**.

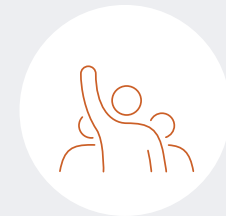

DIFFERENT

We respect individual **DIFFERENCES** and value having **DIFFERENTIATED outcomes**.

FEATURED CASE

SHINHAN LEADERSHIP CODE

The Shinhan Leadership Code is a set of principles that everyone at Shinhan, whether current leaders or aspiring leaders of the future, must adhere to.

RIGHT



NIMBLE



DIFFERENT



<p>Customer driven</p> <p>Leaders think and make decisions from the customers' point of view at all times. Leaders do not make compromises in any circumstances, in order that we can uphold the trust placed in us by customers and society.</p>	<p>Always learn</p> <p>Leaders never cease to learn, and can sense changes in advance. Leaders identify new business opportunities and changes in direction at an organization, even in a complex environment.</p>	<p>Empower others</p> <p>Leaders create an environment in which anyone can speak their mind and be listened to respectfully. Leaders enable and encourage employees to shine, not themselves.</p>
<p>Lead by example</p> <p>Leaders must embody the standards and guidelines that represent the many "invisibles" of our vision and culture as a company. They define our success, and the way we work.</p>	<p>Delete & simplify</p> <p>Leaders speed up the pace of execution by proactively eliminating and streamlining obstacles against change.</p>	<p>Aim for excellence</p> <p>Leaders strive to become the best they themselves can be. Leaders drive the organization to create something great, rather than something that is simply good enough.</p>
<p>Do the right thing</p> <p>Leaders pursue the right way in both process and outcome. Directions are presented with clarity, and evaluations are always fair, so that the right way of working is always put into practice.</p>	<p>Drive challenge</p> <p>Leaders create an organization that is not afraid. Leaders place greater value on the experience and knowledge derived from failures than from easy successes.</p>	<p>Cultivate talent</p> <p>Leaders believe that people are everything. Leaders always seek outstanding talent, actively nurture people, and foster the leaders of the future.</p>

5 Big Questions for Shinhan's Cultural "Re:Boot"

In 2021, as part of the "Re:BOOT" project, five key tasks were derived which have been refined to "five big questions" and best practices for these key tasks were shared Group-wide.

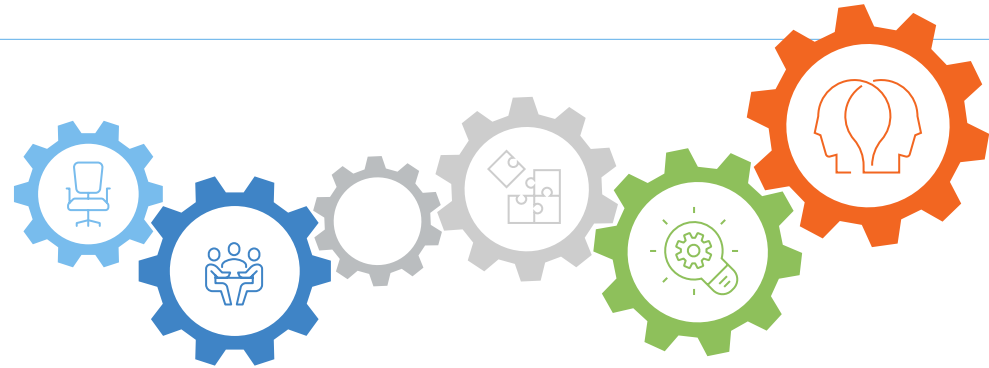

01

Have we drawn up our blueprint from the perspective of our customers?

First and foremost, we have set up a new vision for the Group that states "We believe finance should be More Friendly, More Secure, More Creative", and the Group subsidiaries have aligned and adjusted their own directions from customer's and long-term perspective, and then formulated detailed execution tasks. The CEOs of each subsidiary shared these tasks with their employees via video messages.

02

Have we adjusted the way we work to focus on data-driven work processes?

We have implemented a data-driven governance system which has fundamentally changed the way we work, especially in meetings and writing reports. We also have put into place management and HR systems, thereby boosting the data literacy of our employees and accelerating the organization's decision-making and business execution.

03

Do we have an agile organizational structure which revolves around customers?

Our definition of being agile is "S.A.Q" – speed, agility, quickness – based on which we formed an S.A.Q taskforce to pursue agile transformation at the Group level. We have thus laid the foundations upon which agile organizational systems can be built, while taking into account the unique characteristics and needs of each subsidiary.

04

What tools do we have to encourage employee creativity and initiative?

Activities such as the data-driven HR RE:Boot, the Open Talent Market, and Objective Key Result (OKR) have further improved the fairness of our HR systems. This encourages employees to self-motivate, thus creating a work culture grounded on creativity and initiative.

05

Are tasks prioritized accurately, and then executed efficiently?

Last but not least, in order to ensure that on-going innovation-spurring activities do not become one-off events, we have formed the CEO Culture Round (CCR), a consultative body composed of Group subsidiary CEOs that focuses on work culture. The CCR establishes firm-wide short- and long-term plans for putting RE:Boot into practice, while also executing and managing them efficiently and systematically.

FEATURED
CASE

ETHICAL MANAGEMENT

Shinhan Financial Group is further solidifying the trust-based relationships with its stakeholders through transparent and ethical business management.

In order to internalize ethical management as an inherent part of our corporate culture, and to increase ethical awareness of employees, we established the “Shinhan Financial Group Code of Ethics” and “Standards of Employee Conduct”, and then aligned our business operations accordingly. We offer a range of Group-wide employee training programs on ethics and compliance, and in addition, each subsidiary is undertaking activities to raise employee awareness of ethical compliance, including the issuance of compliance letters, ethics and compliance self-inspections, and both mandatory and voluntary training programs.

Strengthened Internal Controls

At Shinhan Financial Group, the Compliance Officer of the holding company oversees the Group’s internal controls, and also supports each subsidiary in implementing its internal control activities through the “SFG Joint Compliance Monitoring System”. The holding company receives regular compliance and internal transaction reports to ensure that each subsidiary’s internal control activities are being carried out effectively. In addition, every subsidiary is subject to multiple on-site inspections throughout the year to monitor their actual implementation of internal controls. All subsidiaries have an internal controls committee which is chaired by the CEO. These committees assess the effectiveness of internal control operations over the past year, and also review the status of internal control systems. Their findings are then reported annually to the Group Board of Directors.

Whistleblower System

Shinhan Financial Group continues to promote its whistleblower system to ensure proactive and preventative action against unethical behavior, and to build stronger internal controls. The whistleblower program provides a wide range of anonymous reporting channels, including a website, email, a dedicated phone line, and in-person interviews. The program is offered at both Group-level and at each subsidiary.

Anti-Money Laundering

As the anti-money laundering (AML) obligations placed on financial institutions continue to be strengthened, Shinhan Financial Group continues to upgrade its systems in order to implement global standards of AML. All subsidiaries that are subject to AML-related obligations have their own AML internal control processes, tailored to the risks of their own particular industry. In addition, we offer employees training and incentivize our employees to become certified AML experts.

Promoting Fair and Ethical Financial Trading

Shinhan Financial Group has expanded its training on fair, transparent, and ethical financial trading as a way to ensure that it is in compliance with all related laws and regulations. Employees working in the internal control departments of the Group subsidiaries are required to undertake annual training on ethical transactions, and violations are monitored for preventative purposes. Each subsidiary prepares its own internal guidelines on the prevention of unethical trade practices, and also conducts regular employee training and other monitoring activities.

COO's Reflections on Our Human-talent

HELPING OUR TALENT UNLOCK THEIR FULL POTENTIAL



Lee Een-Kyoon
Chief Operating Officer, Shinhan Financial Group

Shinhan is in the middle of the Shinhan RE:Boot project, aimed at transforming the Shinhan culture – what were the drivers behind the project, and where does it stand now?

Shinhan's power comes from its people. And the power of our people comes from Shinhan's culture.

Since its foundation, Shinhan has placed great value on its organizational culture. For instance, the Group's senior executives are committed to having annual discussions on establishing the right culture, which includes the CEO himself, who serves as the Culture Executive Manager. The Shinhan culture has been guiding Korea's financial industry in new directions, and always stood at the forefront of change.

The accelerated digitalization has spurred rapid changes in trends in the financial industry, as well as Shinhan-specific changes such as newly diversified businesses, the emergence of digital natives, and increased complexity of our internal environment. To strategically respond to such changes, we have launched "Shinhan RE:Boot" project, to seek a thorough transformation of the Shinhan culture.

The Shinhan RE:Boot movement embodies our commitment to renewing the Shinhan culture by listening intently to the voices of customers, society and employees, as if we rebooted the computer operating system. Following the announcement of the RE:Boot project, the Group has set out its new vision and rebuilt its core values, which will serve as standards for Shinhan employees.

We acknowledge that this transformation is a journey, and a never-ending mission – it began with the Shinhan cultural forum held on the Group's anniversary date in 2021, but it remains ongoing, with no final destination having been set. We are confident that our continued efforts to highlight the importance of culture and to improve it will earn Shinhan Financial Group great respect from our shareholders and customers, and will enable employees to take pride in their workplace.

2022 will mark the 40th anniversary of Shinhan Financial Group. We take pride in what we have achieved over the past 40 years, but we are not complacent. As Korea's No. 1 financial group, and one which is globally competitive, we will create a corporate culture befitting of a top-tier organization.

What are the challenges of a cultural transformation? In which areas do you want to improve the Shinhan corporate culture?

Inertia always presents challenges to any organization, which is why we have created the "D&R" concept, standing for "Delete and Reload". We are deleting any obstacles which hinder our pursuit of transformation, and we are continually reloading our values of customer focus, creativity, self-motivation, and challenging the future. Shinhan will move away from the conventional hierarchical structure, empower our customer contact points with decision-making authority and responsibility, and generate customer-oriented innovation. In addition, all biases and discrimination will be eliminated (Delete) and the values of fairness and inclusion will be substantially enhanced (Reload). This in turn will stimulate a corporate culture with much greater diversity.

In particular, we are committed to our "Commitment to Diversity and Inclusion" whereby we will establish an environment in which female employees are empowered to drive the Group's growth onwards. We will further expand the Shinhan SHeroes program, first female leadership development program among Korea's financial institutions, to accelerate the strengthening of female leadership. We will also improve our HR policies, personal development programs and organizational culture to assist our female employees grow further and faster.

COVID-19 has shed light on the importance of the well-being of employees. What kind of support programs has Shinhan offered to its employees for their health and safety?

The pandemic has served as a reminder that healthcare is an essential part of good management, and not merely an area of employee welfare. In fact, the World Health Organization (WHO) defines health as a state of complete physical, mental, and social wellbeing. With our top priority placed on the health and safety of our employees, we run a wide range of programs to effectively support and promote employee well-being from physical, mental, and societal perspectives.

In response to quarantine measures limiting physical activities, Shinhan has introduced a digital healthcare service through HowFIT, which also offers a contactless workout program. In addition, our online counseling service is available 24/7, 365 days a year to support our employees' mental health. We also offer online meditation, family counselling, and stress diagnosis and treatment programs. Furthermore, a wide range of Employee Assistance Programs (EAP), including subsidies for medical expenses, are in place. With employee well-being at the heart of Shinhan's competitiveness, we will continue to ensure the health and happiness of all our employees.



62
BUSINESS REPORT

74
CORPORATE GOVERNANCE
REPORT

REVIEW OF OPERATIONS

BUSINESS REPORT

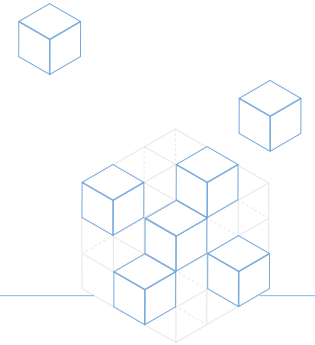

Shinhan Business Organization

Shinhan Financial Group consists of 17 direct subsidiaries that include Shinhan Bank, Shinhan Card, Shinhan Investment Corp., Shinhan Life Insurance, Shinhan Capital and Shinhan Asset Management, and 32 indirect subsidiaries. We provide comprehensive financial services, principally consisting of the following:

- commercial banking services, including retail banking, corporate banking, international banking, and other banking services.
- credit card services;
- securities brokerage services;
- life insurance services;
- asset management services; and
- other services, such as savings banking services, loan collection and credit reporting, collective investment administrative services, financial system development services, real estate trust services, investment advisory services, and venture capital services.

Provider of Optimal Integrated Financial Solutions

In 2011, Shinhan Financial Group adopted a matrix structure in order to maximize the development of synergy among Group subsidiaries by fully leveraging the advantages of a holding company system including the Group's extensive resources, expertise and customer base. With the easing of regulations relating to concurrent positions, we expanded our matrix structure to five divisions (GIB, GMS, Global, WM, Retirement Pension), and also has a separate council for real estate business. This matrix organization has helped the Group to maintain its high growth. The total net income before tax of our matrix businesses grew at a CAGR of 23.2% over the last five years, and their contribution to the Group's total income is expected to continue to increase.

Shinhan's Matrix Organization Structure



Contribution by Matrix Businesses

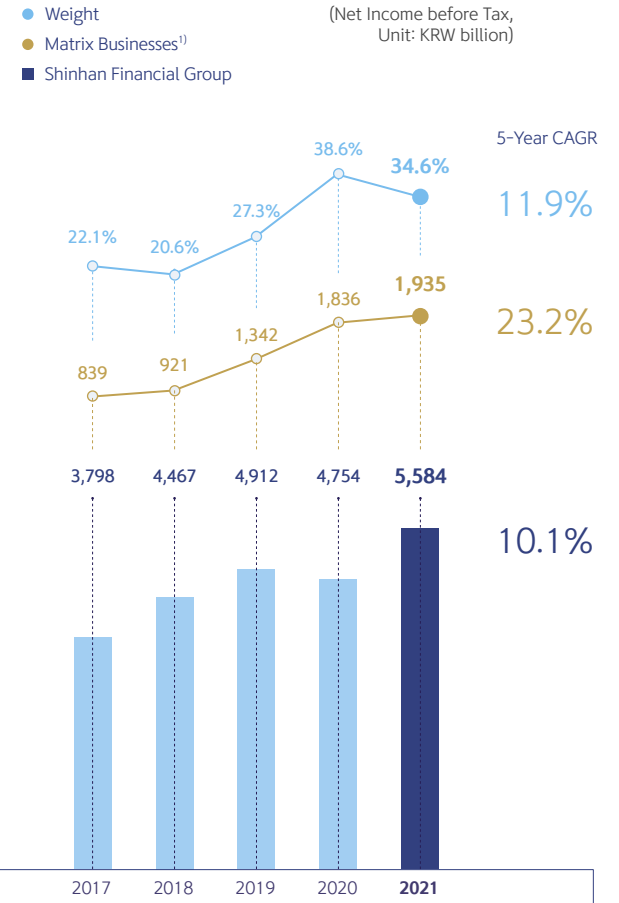

GIB (Group and Global Investment Banking)

Operating income of the Group and Global Investment Banking (GIB) Division increased by KRW 153 billion year-on-year in 2021 to reach KRW 1,069 billion, attributable to a higher market share in syndicated loan arrangements and increased domestic and overseas equity investments – the outcome of our efforts to enhance competitiveness in key IB markets. We also changed internal guidelines, thus expanding the asset groups that can be incorporated into GIB. As a result, we were able to increase the range and amount of asset products available to GIB front departments, enabling us to make inroads into new businesses such as hybrid asset securitization, leading to performance improvement. We also strived to generate growth through sustainable investments. We invested some KRW 1.1 trillion in innovative companies, in connection with the Group-level Triple-K Project, and newly launched the Green IB Execution Cell to identify new businesses related to ESG.

In 2022, Shinhan Financial Group will expand cooperation between the Group subsidiaries, including joint marketing, and thus strengthen key IB capabilities centered around solutions as a way to advance the IB revenue model of GIB. In addition, we will establish a more efficient resource management of the Group subsidiaries and enhance organizational operation capabilities to ensure agile responses to risks and opportunities. Also, continued efforts will be made to expand the earning base and the foundation of growth for our GIB business. To this end, we will upgrade the overseas IB sales system, make more investments in eco-friendly and renewable energy, and identify other new businesses to drive sustainable growth.

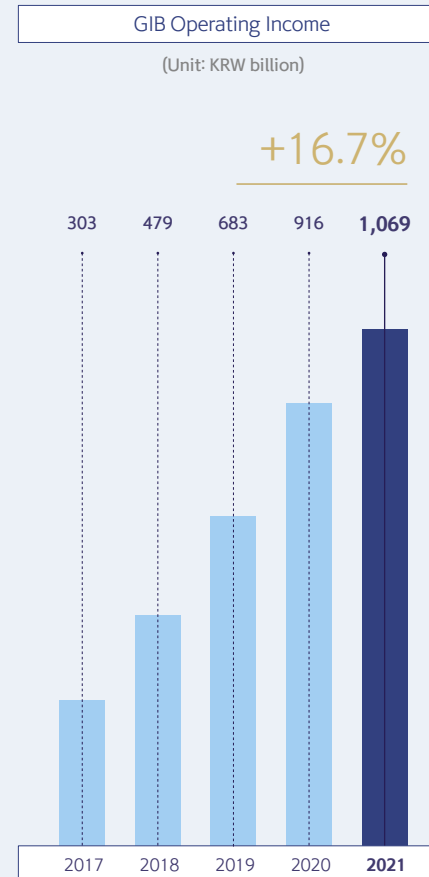

GIB Earnings Highlights

Market competitiveness
in syndicated loan arrangement

M/S 29.3%
(+3.03%p, YoY)

Global IB revenues

397.1 KRW billion
(+KRW 102.2 billion, YoY)

Support for sustainable finance

Investment in innovative growth

1,111.4 KRW billion
(+KRW 557.5 billion, YoY)

Eco-friendly & renewable energy

958.7 KRW billion
(+KRW 153.0 billion, YoY)

GMS (Global Markets and Securities)

In 2021, the Global Markets and Securities (GMS) Division recorded KRW 278.9 billion in net income before tax, and its assets under management (AUM) at the year-end stood at KRW 124.8 trillion. Despite highly volatile market conditions, including rising interest rates, we were able to achieve a stable performance by countering increased market volatility through defensive management strategies and strict risk management. Furthermore, through diversification of our AUMs and asset fragmentation by maturity, our GMS business was able to deliver strong earnings results.

GMS made active inroads into global markets in 2021, with the opening of a local desk in London, and plans to discover diverse overseas income sources in 2022. In particular, we will leverage our expertise to supply quality products to our sales channels, including retail bonds, alternative products and derivative-linked securities, while also strengthening the collaboration system of the Group.

Markets are expected to remain volatile in 2022, GMS will therefore maintain its defensive management strategies. At the same time, we will actively monitor markets in order to seek opportunities for generating income. In addition to upgrading our data-based decision-making, we are increasing our global presence by participating in pre-IPO-related investments managed by leading international investors, and by continuing to improve our products to ensure a strong performance, no matter how volatile markets become.

GMS Assets Under Management

(Unit: %)

Breakdown by Subsidiary

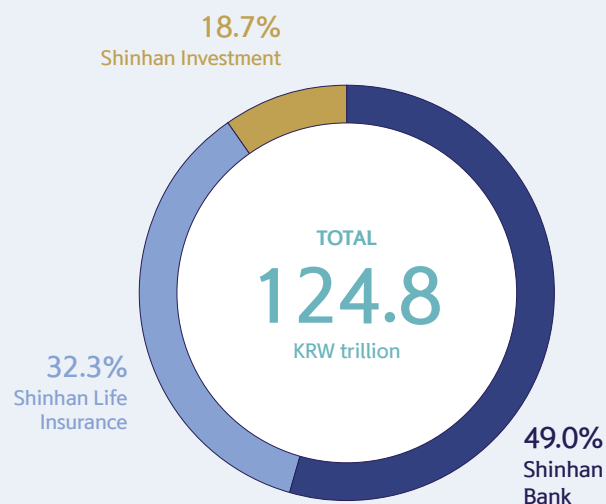

* As of December 31, 2021

Breakdown by Asset Type

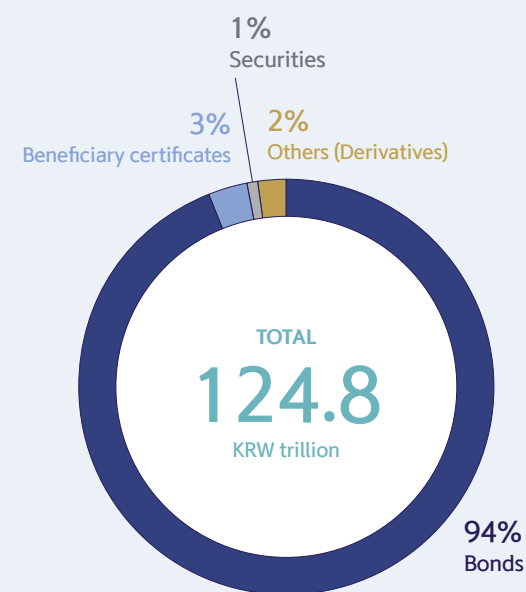

* As of December 31, 2021

Global (Global Business)

In 2021, the Global Business Division recorded KRW 594.5 billion of net income before tax, a year-on-year increase of 10.2%. This was achieved thanks to its resilience in crisis response and the continued growth in retail and corporate loans, despite the difficult global environment due to COVID-19 and political issues.

Six major overseas subsidiaries (Japan, China, Vietnam, US, India, Indonesia) saw growth in non-interest income (net increase of USD 16.9 million or 16.4%), mainly from F/X and derivatives income as well as loan handling fees and commissions. Our major markets (Hong Kong, New York, Singapore, London) led overall growth, with interest income increasing 52.8% or USD 34.3 million thanks to effective management of funding costs.

In 2022, we will work on developing into Asia's leading global company by using customer-centered and data-based decision-making as our driving force. We will generate growth through digital-focused inorganic investments and our ongoing global digital transformation. We will remain selective in our businesses, including the expansion of our digital-based retail business in Asia. In advanced financial markets, we will focus on financial institutions, IB-centered corporate banking and sourcing global products.

In addition, we will strengthen the non-banking business by building a balanced portfolio. To this end, we will expand the global reach of Shinhan Card and Shinhan Investment, and further strengthen Shinhan Life Insurance's business in Vietnam. We will also leverage the global capabilities of all Group subsidiaries in order to bring about "global connection and expansion" between operations in Korea and the overseas channels.

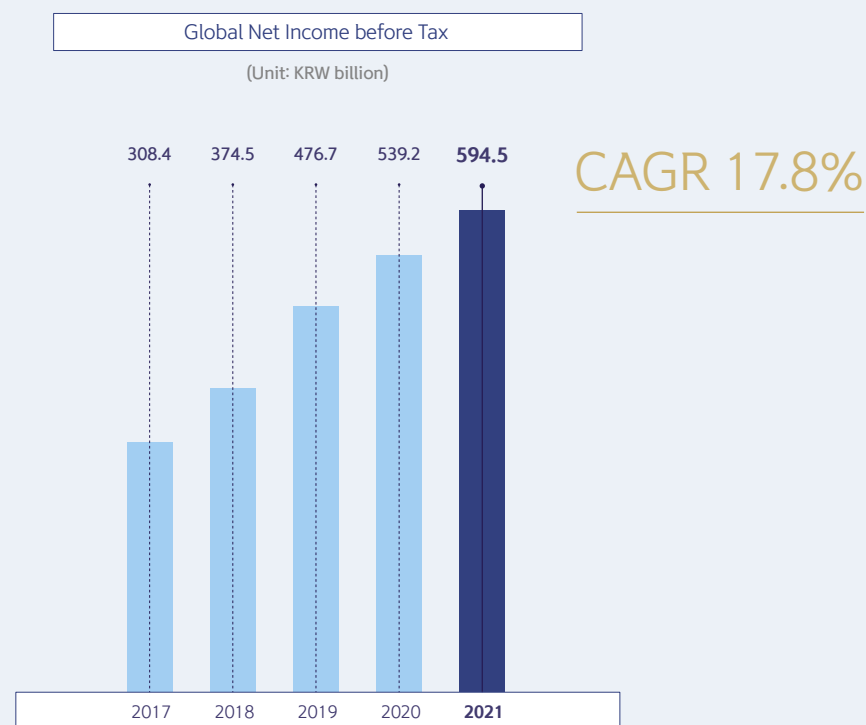

WM (Wealth Management)

The Wealth Management (WM) Division places top priority on customer trust and aims for stable portfolio and increased customer wealth. In 2021, AUM of our WM business rose by KRW 7.3 trillion year-on-year to reach KRW 53.6 trillion, driven by a significant rise in the number of high-net-worth individuals (HNWIs). We have one of the largest number of HNWIs in our client base with 17,500 customers with KRW 1 billion or more, and 46,100 customers with KRW 500 million or more in financial assets entrusted in Shinhan's accounts. Such growth has been achieved thanks to new internal evaluation methods and KPIs focused on customer rates of return and asset growth, and strengthened product-governance which covers products from launch to sales and post-sale follow-up.

We are living in a new era of high capital mobility where the borders between banking and securities are blurring. Against such a backdrop, we have launched the "Family Office Center" in February 2022, providing exceptional total life-cycle wealth management solutions and other financial advisory services for high-net-worth families and entrepreneurs. We are also focused on upgrading our digital wealth management platform so that customers can benefit from all of our WM services without face-to-face contact, in particular through our SOL PB and SOL Premier Lounge platforms. Going forward, we will solidify our leading position by continuing to expand our digital presence and by launching distinctive services for HNW individuals.

WM Assets Under Management

(Unit: KRW billion)

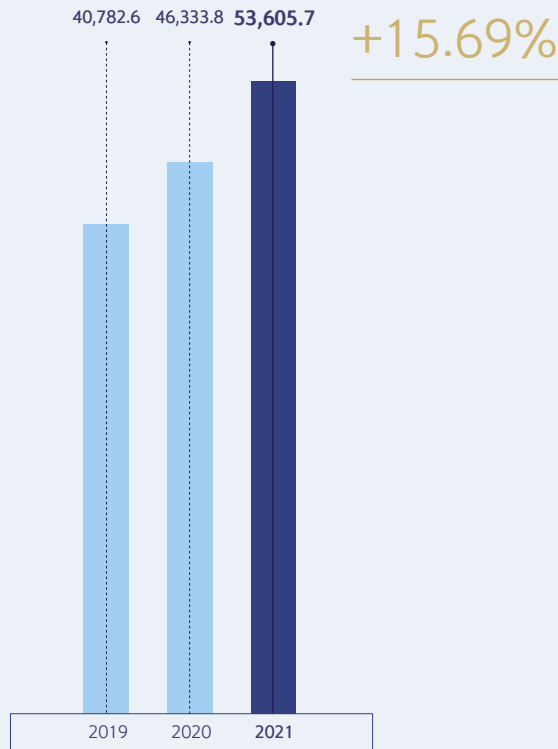

WM Assets Client Base*

(Unit: Persons)

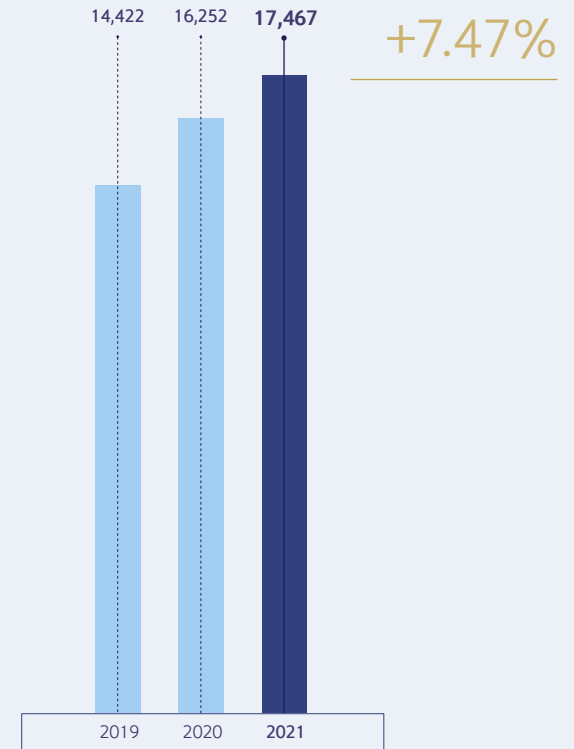

* Customers with more than KRW 1 billion financial assets in Shinhan accounts

Retirement Pension

With the retirement pension market increasingly focused on customer rates of return, there has been a shift towards defined-benefit (DB) pension and individual retirement pension (IRP) products. In addition, the collapse of the boundaries between banking, securities and insurance has been disadvantageous to the banking sector. Despite this challenging environment, the Retirement Pension Division had managed reserves of KRW 34.7 trillion as of 2021 year-end, a year-on-year increase of KRW 4.2 trillion, thanks to increased sales of DC and IRP products, making Shinhan Financial Group maintain its leading position, with 11.7% of market share, in the retirement pension market for five consecutive years. In particular, Shinhan Bank achieved stronger growth than any other commercial banks in Korea in terms of a net increase in deductibles, maintaining its solid growth pace.

In order to better respond to the large capital flows across different financial industrial segments, the Division changed its growth strategy for 2022. Under the new growth strategy, the Division will focus on generating growth from DC and IRP products and minimizing customer attrition. The sales focus will be on encouraging installments or monthly payments throughout the year, rather than a year-end lump sum payment. We will also strive to expand our non-face-to-face sales channels and to use big data-based analysis to better understand our customers. We will also increase our range of ETF and TDF investment products and diversify our product groups, while improving our asset management by more effectively measuring and managing customer rates of return.

As a way to strengthen our customer management, we are improving our DC/IRP customer management system by opening more Customer Management Centers. We are also upgrading non-face-to-face customer service infrastructure by offering AI voice counseling, and using both target-date funds and robo-advisors.

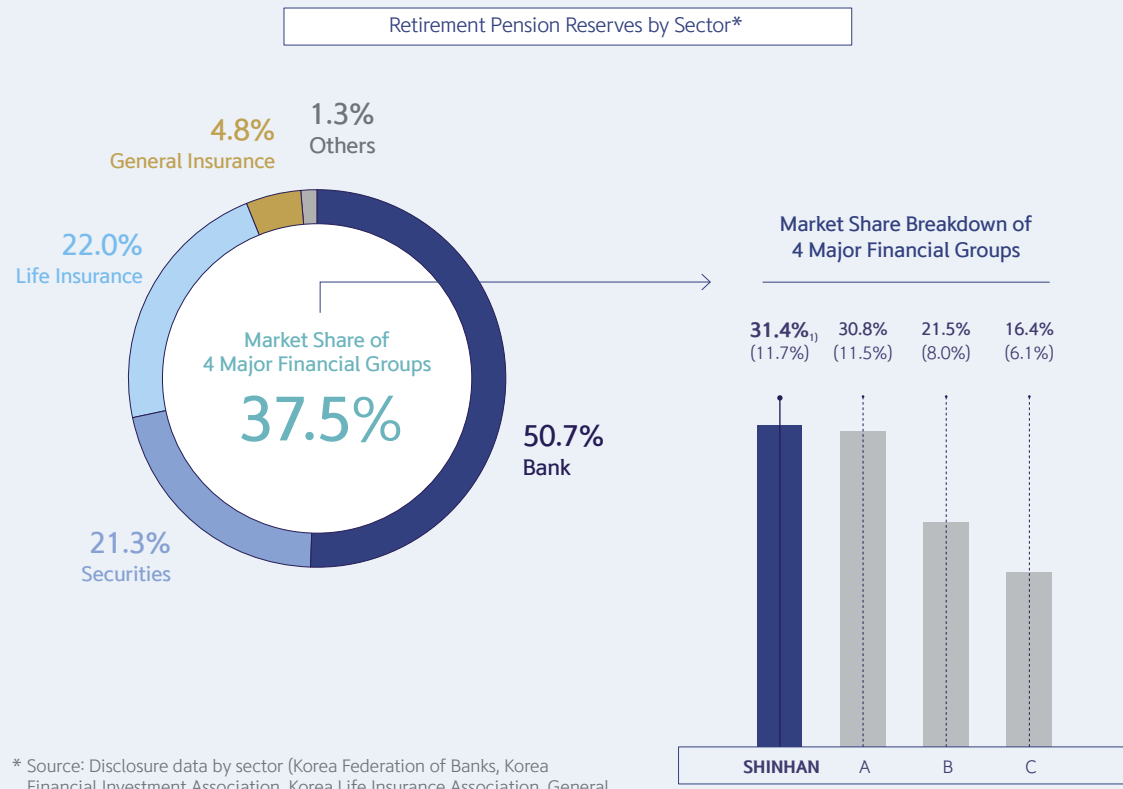

* Source: Disclosure data by sector (Korea Federation of Banks, Korea Financial Investment Association, Korea Life Insurance Association, General Insurance Association of Korea); and as of the end of 2021

¹⁾ Figures in brackets mean the share of entire market

Real Estate

The Real Estate Business Line was launched in August 2019, after the acquisition of Asia Trust in May 2019, to provide customers with products and services right across the real estate lifecycle. The Group Real Estate Strategy Committee, where the Real Estate Sector within the GIB Division plays a leading role, is held twice a year to discuss strategic directions of the Group-level real estate business, and to promote Group-wide synergy in real estate. The Real Estate Sector is composed of staff from Shinhan Bank, Shinhan Investment, Shinhan Life Insurance, and Shinhan Capital, and staff from Asia Trust and Shinhan Asset Management also participate in the Committee.

With the acquisition of Asia Trust, we are now licensed to offer financial services across the entire value chain in real estate from planning and development to sales and disposal after management. Moreover, we can leverage the wide range of financial services offered by our different subsidiaries by, for example, including, among others, offering real estate debt funds and trusts to our retail products through our banking and securities subsidiaries, and connecting our WM clients with a wide range of real estate advisory services such as development as well as sales and management.

In 2021, our Real Estate Business Line focused on Group-wide collaboration and synergy creation. As a result, we were involved in 50 deals and KRW 5.4 trillion worth of financial arrangements, with direct participation amounting to KRW 2 trillion.

In particular, we worked successfully on several large-scale projects, including the Magok CP4 complex development project, the Busan BIFC phase 3 development project, and the Uiwang Baegun Valley 2-1, 2 block development project.

In 2022, we will improve how we source information on the real estate market and innovate our internal systems by building a real estate network platform. In addition, we will leverage capabilities across the Group to target deals and win multiple large-scale projects, which will be supported by a working-level council under the Group Real Estate Strategy Committee.



Magok CP4 complex development project



Busan BIFC phase 3 development project

RE-VALUATION OF SHINHAN ON THE VERGE OF BREAKTHROUGH



Heo Young Taeg
Chief Management Officer, Shinhan Financial Group

What are the roles and responsibilities of the Chief Management Officer (CMO), and what is your business plan for 2022?

I was appointed to oversee the business management and performance of our subsidiaries, as well as the matrix-structured businesses when the Group Business Management teams were newly launched in January 2021. My primary responsibility is to generate synergy between the Group subsidiaries, and to manage the 15 subsidiaries and five matrix business lines in order to achieve optimal performance across markets and industries.

My goal for 2022 is to make it the first year of Shinhan's "Re-valuation". The Group's strategic direction is "Breakthrough 2022, RE:Boot Shinhan", setting out how Shinhan will renew itself by breaking through the challenges of markets and the competitive environment. Taking a step in this direction, our teams will thoroughly manage and fully support all Group subsidiaries and matrix business lines so that they can generate extraordinary outcomes.

In 2022, in particular, we will focus on subsidiary management as a way to help them achieve outstanding performance. To this end, we will offer active support to secure leading positions in areas we excel in, and to build competence in other business areas.

We will also continue to generate the highest levels of market confidence in Shinhan by delivering market-leading performance in its digital strategy, capital markets business, and asset management business. In addition, we are motivating all Group subsidiaries to develop more drivers of future growth by, for example, upgrading our subsidiary evaluations to include quantitative indicators related to digital technology and the customer base.

What do the Business Management teams view as the key tasks for 2022?

The most important tasks for this year are to strengthen our completeness based on strong fundamentals, and to enhance our position in the capital markets. We will therefore increase monitoring of business fundamentals from the perspective of profitability and efficiency.

We will also support and coordinate between Group subsidiaries so that they can achieve ground-breaking increases in MAUs of their digital platforms and the size of the customer base targeting digital natives, including Millennials and Generation Z.

While pursuing strong growth in interest income, we believe that it is also important in the current regulatory environment to build the foundations for mid- to long-term growth by diversifying our non-interest income.

To this end, we plan to focus on three major areas for a robust growth of our non-interest income. First, we will further strengthen our capabilities in capital markets business. We will aim to increase investment banking (IB) and FX derivative-related income by offering more of such services to more corporate clients. We will also strengthen our capital market-related retail sales, strive for higher rates of return on key asset management products, and further advance our position in alternative investments. Second, we will focus on bolstering our trust fee income. At Shinhan Bank, we plan to offering even more attractive retirement pension products, while at Asia Trust, we are expecting an increased commission income through growth in the property trust business as well as an increase in ownership. Lastly, we will focus on other sources of income, including an increase in dividends and gains on valuation through expanded investments in new technologies and venture firms. We will also generate income from our new data-based businesses.

Shinhan benefits from its matrix business system, but there must be other areas in which synergy can be generated between the Group subsidiaries. Do you have any specific plans for enhancing cooperation between them?

When it comes to synergy between the Group subsidiaries, many people generally first think of the matrix business system, and the cooperation across the Group's real estate business line. This is entirely natural since these businesses connect several Group subsidiaries. However, cooperation within the Group is not limited to the matrix system. In 2021, a number of internal organizations held discussions on generating positive outcomes through collaboration, including the One Shinhan Strategy Council, the Joint Business Council, and the Group MZ¹⁾ Working Group. These discussions led to positive and tangible outcomes, including a bigger MZ customer base, better performance in auto finance, and linked-up marketing in connection with the launch of integrated payment service.

Based on these successes, in 2022 we will increase cooperation between all the Group organizations which focus on the MZ customer. We will aim for seamless connections between Shinhan Plus and other Group subsidiary apps in order to increase our offerings of services and content, and to add more external alliances. In addition, we will implement targeted cross-subsidiary marketing to expand the key customer base. Finally, we will quickly respond to changes in the market environment by providing full support for increased cooperation among Group subsidiaries in key areas such as digital transformation, new business, and IPOs.

¹⁾ Compound word of Millennials and Generation Z

Focusing the capabilities of all of Shinhan into one powerful synergy generation

Shinhan Financial Group is implementing its “One Shinhan” strategy in order to promote close cooperation between the Group subsidiaries and to build an effective management system at the Group level. One Shinhan is not just a slogan, but a strategy shared by all the Group subsidiaries, aimed at providing all customers with optimized products and services. We will create more customer value by adapting to changes in our business environment, including money movement and the accelerated transition to a digital economy, and also by leveraging digital technology to make One Shinhan truly distinctive in a “right, nimble, different” way.

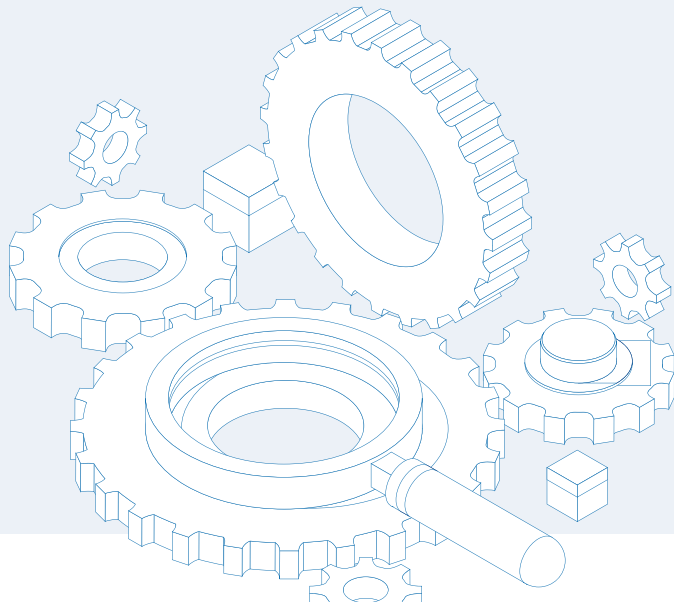

In 2021, Shinhan Financial Group segmented customers and markets from the perspective of actual transactions, and used this information to develop areas of cooperation between the Group subsidiaries, thereby expanding the Group customer base. Shinhan Bank launched “The More” installment savings product in connection with Shinhan Card’s “The More” credit and debit card”, targeting customers in their 20s and 30s. Building upon the success of “The More” product series, the Group launched various sets of hybrid products, including the launch of Shinhan Card’s “Meme Card” for teenagers, and increased the overall cross-selling of the Group’s products. In response to the huge capital inflow into the capital market, we undertook a more aggressive Group-wide marketing of brokerage-type ISAs and securities-related products. In addition, as the transition to a digital economy moves ever faster, we leveraged the Group’s wide customer base to spur increased cross-selling among our subsidiaries through our digital platforms, including the integrated Shinhan Pay and Shinhan MyCar joint platform. The Group subsidiaries also made joint efforts in speeding up the distribution of COVID-19 government subsidies.

In 2022, Shinhan Financial Group will increase customer value and expand cooperation between the Group subsidiaries by building a digital-based One Shinhan collaboration system and strengthening the new business value chain. In order to better respond to changes in the digital environment while also increasing the cross-selling ratio within our customer base, we will offer more financial products and services through digital channels and upgrade non-face-to-face marketing through the stronger connection between the Group integrated platform “Shinhan Plus” and the apps run by subsidiaries.

In addition, we will expand areas of collaboration among the Group subsidiaries to offer a more comprehensive financial solution for our clients by, for example, establishing a comprehensive financial service model¹⁾ offered by the exceptional financial consultants (FCs) from our newly-integrated insurance subsidiary, and offering a comprehensive real estate service²⁾ which brings together the capabilities of our Real Estate Business Line and Asia Trust. One key task will be to increase the number of customers in their 20s and 30s, as they will be the foundation of our future growth. To this end, we will strengthen collaboration between our subsidiaries, namely Shinhan Bank, Shinhan Card, Shinhan Investment, and Shinhan Life Insurance, and expand both internal and external communications while also working together with our customer advisory groups to make our products and services truly distinctive and attractive to the young generation.

¹⁾ Comprehensive financial service model seeking to widen the range of products offered by our FCs to include credit cards, retirement pension products, loans, etc.

²⁾ Comprehensive real estate service that combines the real estate investment advisory capabilities of Shinhan Bank and Shinhan Investment with the real estate development consulting, development agency, and management capabilities of Asia Trust

Active Customers and Cross-selling Ratio

(Unit: million persons, %)

Classification	2018	2019	2020	2021	YoY
No. of active customers ¹⁾	18.82	18.99	19.14	19.54	+0.40
No. of cross-selling customer ²⁾	7.47	7.64	7.87	8.22	+0.34
Cross selling ratio	39.7%	40.2%	41.1%	42.0%	+0.9%p

¹⁾ Sum of active customers of Shinhan Bank, Shinhan Card, Shinhan Investment, and Shinhan Life Insurance (excluding double counts)

²⁾ No. of active customers who have business with two or more of Shinhan's major subsidiaries, which are Shinhan Bank, Shinhan Card, Shinhan Investment, and Shinhan Life Insurance.

Synergy Creation

We are going beyond the collaboration centered around Shinhan Bank and Shinhan Card, and increasing collaboration in new business segments centering on other subsidiaries, such as Shinhan Investment and Asia Trust.

(Unit: KRW billion)

Classification	2020	2021	YoY	Growth rate
Profits generated through synergy effect ¹⁾	257.2	308.7	+51.5	+20.0%
Shinhan Bank & Shinhan Card	76.0 ²⁾	84.7	+8.7	+11.4%
Others	181.3	224.0	+42.8	+23.6%

¹⁾ Sum of profits generated through the collaboration of major subsidiaries of Shinhan – Shinhan Bank, Shinhan Card, Shinhan Investment, Shinhan Life Insurance, Shinhan Capital, Shinhan Asset Management, Jeju Bank, Shinhan Savings Bank, and Asia Trust (excluding private equity investments and IB-related earnings)

²⁾ Excluding one-off factors

CORPORATE GOVERNANCE REPORT

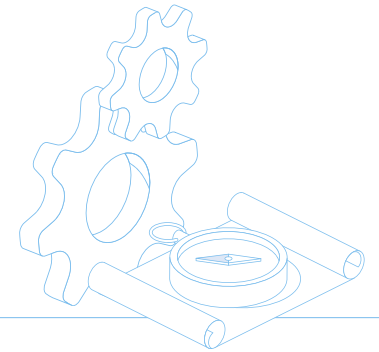

Shinhan Corporate Governance

Shinhan Financial Group has established a governance structure and principles that promote the interests of shareholders, protect the rights of stakeholders, enhance corporate value, and achieve sustainable growth. Thanks to our commitment to these principles and policies, we run our business ethically and with a sense of responsibility.

Our outstanding corporate governance has garnered outside recognition. For example, in the ESG assessment carried out by the Korea Corporate Governance Service (KCGS), we have received an integrated assessment rating of A+ for seven consecutive years since 2015, and obtained an S rating in the governance category in 2017. In addition, we continued to receive the highest-possible rating even when a more demanding assessment model was applied to financial institutions beginning in 2018..

[SFG's Corporate Governance Report](#)



[Convocation Notice of
the 21st AGM & Proxy Supplements](#)



Principles of Governance Structure

Transparent Governance Structure

We actively disclose our governance-related standards, procedures, and outcomes to ensure transparent corporate governance. We share corporate governance-related matters with all stakeholders by publishing an annual corporate governance report, disclosing it on the company website, and then submitting it to the Korea Federation of Banks, 20 days prior to the annual general meeting (AGM). In March 2022, we made improvements in the contents of our convocation notice while also providing an additional proxy supplement material, thus offering a more in-depth information on the AGM agenda as well as on the Group's overall corporate governance structure in a more reader-friendly format.

In addition, we help our stakeholders understand operational practices concerning corporate governance by disclosing the full text of our internal corporate governance regulations in the annual corporate governance report. These include the Articles of Incorporation, BOD regulations, and the regulations of each sub-committee of the BOD.

It is particularly noteworthy that we use a cumulative voting methodology in order to protect the rights of minority shareholders at AGMs, and use both an electronic voting system and a system enabling shareholders to vote in writing in order to actively guarantee shareholder voting rights. We also offer fair and timely information at AGMs by providing real-time video streaming.

Sound Governance Structure

We have formed a Board of Directors (BOD) equipped with the independence and expertise necessary to maintain sound corporate governance. We faithfully abide by all laws, including the Commercial Act and the Act on Corporate Governance of Financial Companies, and all internal regulations, including the Articles of Incorporation, the code of corporate governance, and the regulations of the BOD. In addition, all recommendations in relation to BODs stipulated in the Act on Corporate Governance of Financial Companies and the KCGS Corporate Governance Code are reflected in the Group's corporate governance, and strictly observed.

Stable Governance Structure

In order to ensure stable governance structure through checks and balances among our constituents, we have delegated our decision-making and operation to the Board and the management, respectively, and the management reports the status of their execution of duties to the Board. The Company also actively promotes the Board's Independent Directors-centered activities by filling a majority of each subcommittee with Independent Directors. The Board is granted the authorities to appoint and dismiss CEO (executive director) and senior management. Independent Directors have the authority to request data, advisory services, etc., while the Company has the obligation to provide this information to Independent Directors.

In particular, if an Independent Director has excellent abilities in handling duties, the Independent Director's tenure is guaranteed within the scope of observing external laws and internal rules, in consideration of the Company's governance stability and continuity as well as Board expertise.

In addition, to keep Clubby Boards of Independent Directors in check, we do not appoint an Independent Director who is included in the group of candidates subject to re-appointment as a member of the Independent Director and Audit Committee Member Recommendation Committee unless there are inefficiencies in Committee composition. Even if an Independent Director who is a part of the group of candidates subject to re-appointment unavoidably becomes a member of the Independent Director and Audit Committee Member Recommendation Committee for efficient Committee composition, the Independent Director is fundamentally prohibited from recommending him/herself and participating in a vote on his/her own recommendation agenda item pursuant to regulations. Also, the age of the CEO & President is restricted to 70 or less to result in the full establishment of a virtuous cycle of management succession.

Diversity and Expertise of the Board of Directors

Shinhan Financial Group specifies the principle of diversity in the composition of the BOD in its internal code of corporate governance, so that Board members do not all share a common background or represent certain interests. Moreover, we use a “Board Skill Matrix” to confirm diversity and expertise of the Board members. They also have a wide range of expertise, which prevents the BOD from leaning too much towards a specific background or occupational group. The independent members of the BOD evenly represent the six sectors stipulated as required expertise in the Act on Corporate Governance of Financial Companies, specifically finance, business administration, economics, legal affairs, accounting, and information technology.

The Company also considers diverse recommendation channels and perspectives regarding the Board’s composition and the selection of Independent Director candidates, including from shareholders, the Independent Director and Audit Committee Member Recommendation Committee, and outside agencies. By operating a system which invites shareholders to recommend candidates as independent directors, we receive recommendations for candidates who are fully committed to independently representing shareholder value, and also enable shareholders to participate in management.

We are dedicated to increasing female representation on the Board. At the 2020 AGM, Yoon Jaewon, a female independent director with expertise in accounting, was appointed to join our Board, and in March 2022, Kim Jo Seol, a female independent director with expertise in economics, was appointed.

We also ensure that the candidate group represents diversity in experience, background, and age, while factors that could restrict diversity, such as race, ethnicity, and religion are strictly taken out of the consideration for the candidacy. This is helping us in our efforts to abide faithfully by the principle of diversity in the composition of the BOD.

[Board Diversity Guidelines](#) 

Board Composition

* As of March 2022

Director	Independence	Gender	Key Expertise ¹⁾	Director Since
Cho Yong-byoung	Executive	M	Finance , Business Management	March 2017
Lee Yoon-jae	Independent	M	Economics , Finance, Business Management	March 2019
Kwak Su Keun	Independent	M	Accounting , Business Management	March 2021
Kim Jo Seol	Independent	F	Economics , International Business	March 2022
Park Ansoon	Independent	M	Business Mgt. , International Business	March 2017
Bae Hoon	Independent	M	Legal , Accounting, Business Management, International Business	March 2021
Byeon Yang-ho	Independent	M	Finance , Business Management, Economics	March 2019
Sung Jaeho	Independent	M	Legal , International Business	March 2019
Yoon Jaewon	Independent	F	Accounting , Business Management	March 2020
Lee Yong Guk	Independent	M	Legal , International Business	March 2021
Jin Hyun-duk	Independent	M	Business Management , International Business	March 2020
Choi Jae Boong	Independent	M	Technology	March 2021
Huh Yong-hak	Independent	M	International Business , Finance, Business Management	March 2019
Jin Ok-dong	Non-executive	M	Finance , Business Management, International Business	March 2019

¹⁾

Skills/Qualifications	Description
Finance	Understanding of financial market, reporting, and management strategies
Economics	Ability to interpret macro-economic trends and events
Business management	Current or past leadership roles as top or senior executives
Accounting	Accounting expertise overseeing the integrity of financial reporting
Legal	Legislative experiences gained as policy practitioners and legal professionals, or from the academia and relevant associations
Technology	Experience with or oversight of information system, fin-tech or privacy, cyber security and their related risks
International Business	Experience in diverse geographic, political and regulatory environments

Board Sub-Committee Structure

As the company's top-level standing decision-making body, Shinhan Financial Group's BOD is vested with the authority to appoint and dismiss the CEO, and mainly consists of independent directors. As of the end of March, 2022, the BOD comprises a total 14 members, of which 12 are independent directors. Since March 2010, it has been regulated that an independent director serves as the BOD Chairperson.

As of March 2022, there are a total seven sub-committees of the Board – the Independent Director and Audit Committee Member Recommendation Committee, CEO Recommendation Committee, Audit Committee, Remuneration Committee, Risk Management Committee, ESG Strategy Committee, and Subsidiary Management Committee. Of these, the establishment of the Independent Director and Audit Committee Member Recommendation Committee, CEO Recommendation Committee, Audit Committee, Remuneration Committee, and Risk Management Committee has been made mandatory by such laws as the Act on Corporate Governance of Financial Companies. The BOD autonomously established the other two remaining committees to enhance BOD expertise, independence, and efficiency.

With regards to recommending candidates for executive positions, the Group operates the Independent Director and Audit Committee Member Recommendation Committee and CEO Recommendation Committee. Enforced on August 1, 2016, the Act on Corporate Governance of Financial Companies obligates the establishment of the executive recommendation committee, which recommends candidates for executives, such as independent directors, chairman, CEO, and audit committee members.

Even before the enforcement of relevant laws, the Group segmented the authority to recommend executives and divided it among sub-committees of the Board.



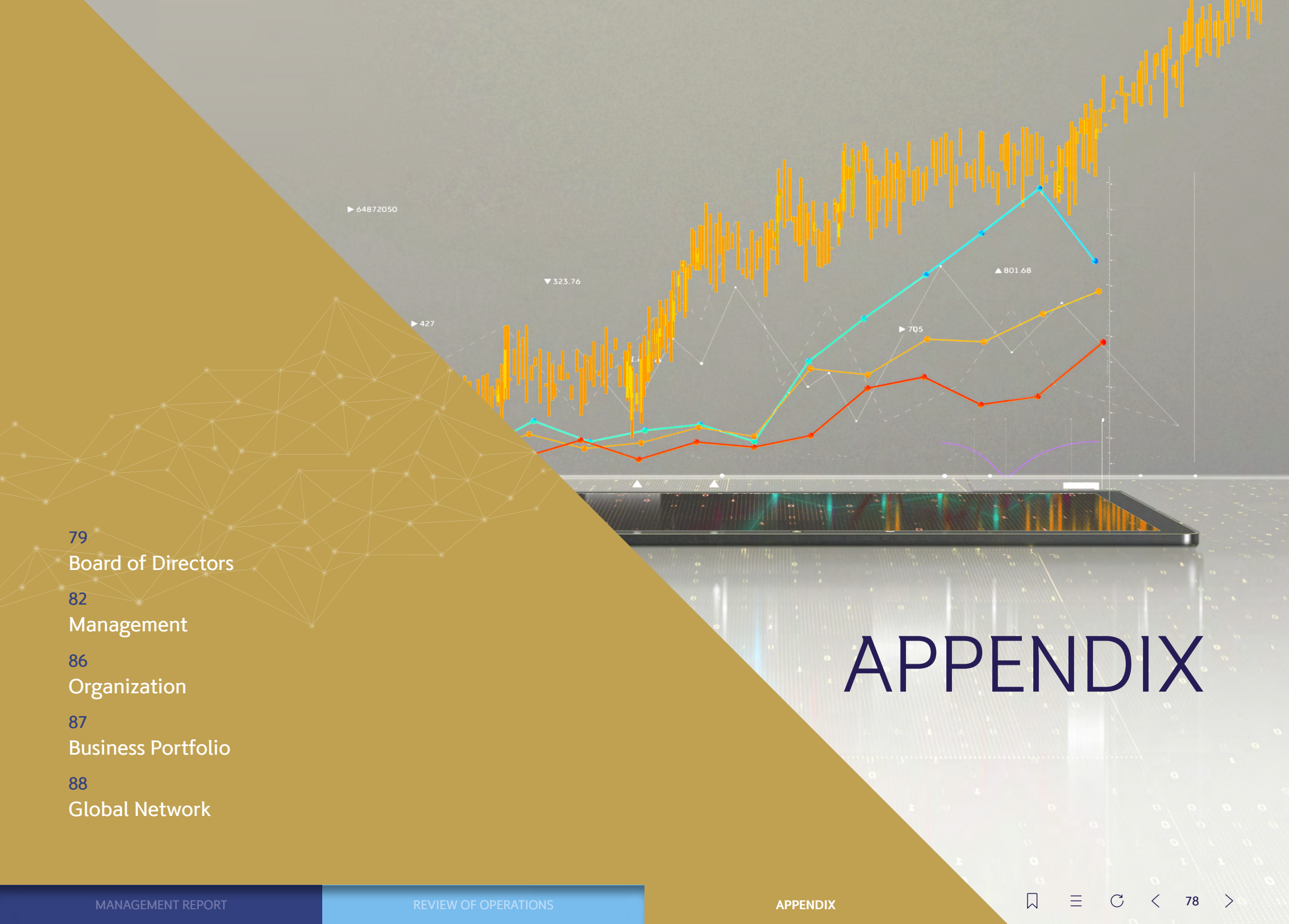

- 79 Board of Directors
- 82 Management
- 86 Organization
- 87 Business Portfolio
- 88 Global Network

APPENDIX

INDEPENDENT DIRECTORS

Lee Yoon-jae (Chair of the Board)

Date of Birth November 3, 1950
Current Position Retired CEO, KorEI
Education AMP, Harvard Business School
 MBA, Stanford Graduate School of Business

Main Work Experience

2015-2018 Independent Director, CJ Freshway
 2012-2016 Independent Director, Busan Bank
 2009-2014 Independent Director, LG
 2001-2010 CEO, KorEI

Kwak Su Keun

Date of Birth August 16, 1953
Current Position Honorary Professor of Accounting, Seoul National University, Business School
Education Ph.D. in Business Administration, University of North Carolina Chapel Hill
 M.A in Business Administration, Seoul National University
 B.B.A, Seoul National University

Main Work Experience

2018-Current Honorary Professor of Accounting, Seoul National University, Business School
 2019-Current Chair of Corporate Governance Advisory Board, Korea Listed Companies Association
 2012-2014 Chair of Financial Supervisory Advisory Committee, Financial Supervisory Service
 2011-2020 Independent Director, LS
 2004-2012 Non-executive Member, Securities and Futures Commission

Kim Jo Seol

Date of Birth December 5, 1957
Current Position Professor, Department of Economics, Osaka University of Commerce
Education Ph.D. in Economics, Osaka City University

Main Work Experience

2020-Current Professor, Department of Economics, Osaka University of Commerce
 2021-Current Executive Director and Vice-chairman of the Association of North-east Asia
 2017-2019 Advisory member of the Presidential Advisory Committee for the Peaceful Unification Advisory Council

Park Ansoon

Date of Birth January 24, 1945
Current Position Chairman, Taisei Group Co., Ltd.
Education B.A. in Philosophy, Waseda University

Main Work Experience

2010-Current Chairman, Taisei Group Co., Ltd.
 2018-Current Chairman, the Korean Residents Union in Japan
 2012-2018 Vice Chairman, the Korean Residents Union in Japan

BOARD OF DIRECTORS (continued)

Bae Hoon

Date of Birth	March 30, 1953
Current Position	Representative Attorney, Orbis Legal Profession Corporation
Education	MBA, Kobe University Graduate School B.A in Economics, Kyoto University
Main Work Experience	
2003-Current	Representative Attorney, Orbis Legal Profession Corporation
2006-2012	Director, LAZAK (Lawyers Association of Zainichi Korea)
2002-2006	Co-representative Attorney, LAZAK (Lawyers Association of Zainichi Korea)

Byeon Yang-ho

Date of Birth	July 30, 1954
Current Position	Company Advisor, VIG Partners
Education	Ph.D. in Economics, Northern Illinois University M.A in Economics, Northern Illinois University B.A in International Trade, Seoul National University
Main Work Experience	
2016-Current	Company Advisor, VIG Partners
2011-2015	Non-Executive Director, TongYang Life Insurance
2005	Founder of Korean 1st Private Equity Fund, Vogo Fund
2004-2005	President, Korea Financial Intelligence Unit

Sung Jaeho

Date of Birth	March 18, 1960
Current Position	Professor, Sungkyunkwan University School of Law
Education	Ph.D. in Law, Sungkyunkwan University Masters in Law, Sungkyunkwan University Bachelor of Laws, Sungkyunkwan University
Main Work Experience	
1994-Current	Professor, Sungkyunkwan University School of Law
2018-2019	Independent Director, NICE Holdings
2015-2019	Independent Director, Shinhan Card
2015	Chairman, Korea Council of International Law

Yoon Jaewon

Date of Birth	August 29, 1970
Current Position	Professor, College of Business Administration, Hongik University
Education	Ph.D. in Accounting, Korea University
Main Work Experience	
2004-Current	Professor, College of Business Administration, Hongik University
2017-Current	Member, Committee on Development Tax System, Ministry of Economy and Finance
2017-Current	Member, Committee on National Accounting policy, Ministry of Economy and Finance
2013-2019	Non-executive Judge, Tax Tribunal

Lee Yong Guk

Date of Birth	May 11, 1964
Current Position	Clinical Professor, Seoul National University, School of Law
Education	J.D., Harvard University Law School B.A. Princeton University, Woodrow Wilson School of Public and International Affairs
Main Work Experience	
2020-Current	Clinical Professor, Seoul National University, School of Law
1992-2019	Attorney, Cleary Gottlieb Steen & Hamilton LLP.
2014-2019	Director, Foreign Law Firm Association

Jin Hyun-duk

Date of Birth	September 10, 1955
Current Position	CEO, PHOEDRA Co., Ltd.
Education	MBA, Keio Business School
Main Work Experience	
1988-Current	CEO, PHOEDRA Co., Ltd.
Current	Councilor, The Korea Educational Foundation
2014-Current	Visiting Professor, Business administration, Sakushin-gakuin University, Japan
2014-Current	Visiting Professor, Engineering, Utsunomiya University, Graduate School, Japan

BOARD OF DIRECTORS (continued)

Choi Jae Boong

Date of Birth February 18, 1965
Current Position Professor, Sungkyunkwan University,
College of Engineering
Education Ph.D. in Mechanical Engineering,
University of Waterloo
M.A. in Mechanical Engineering,
University of Waterloo
B.A. in Mechanical Engineering,
Sungkyunkwan University

Main Work Experience

2009–Current Professor, Sungkyunkwan University,
College of Engineering
2019–Current Director, Sungkyunkwan University,
Human-centered Convergence Design Project
(BK21+)
2018–2019 Policy Advisor, Innovative Growth Committee,
Ministry of Strategy and Finance
2014–2021 Independent Director, E-mart

Huh Yong-hak

Date of Birth September 10, 1958
Current Position CEO, First Bridge Strategy Ltd.
Education M.S. in International Affairs, Columbia University

Main Work Experience

2015–Current CEO, First Bridge Strategy Ltd.
2008–2014 CIO of Alternative Investment,
Hong Kong Monetary Authority
2004–2008 Executive Director of Asia Investment Banking
Division, HSBC
2003–2004 Managing Director, Olympus Capital Investment

EXECUTIVE DIRECTOR

Cho Yong-byoung

Date of Birth June 30, 1957
Current Position CEO, Shinhan Financial Group
Education B.A. in Law, Korea University

Main Work Experience

2017–Current CEO, Shinhan Financial Group
2015–2017 President & CEO, Shinhan Bank
2013–2015 CEO, Shinhan BNP Paribas Asset Management
2011–2013 Deputy President, Shinhan Bank

NON-EXECUTIVE DIRECTOR

Jin Ok-dong

Date of Birth February 21, 1961
Current Position President & CEO, Shinhan Bank
Education MBA, Chung Ang University

Main Work Experience

2018–Current President & CEO, Shinhan Bank
2017–2018 Deputy President, Shinhan Financial Group
2017 Deputy President, Shinhan Bank
2015–2016 CEO, Shinhan Bank Japan

MANAGEMENT

EXECUTIVE MANAGEMENT TEAM

Cho Yong-byoung

Date of Birth June 30, 1957

Current Position Chief Executive Officer (CEO),
Shinhan Financial Group

Education B.A. in Law, Korea University

Main Work Experience

2017-Current CEO, Shinhan Financial Group

2015-2017 President & CEO, Shinhan Bank

2013-2015 CEO, Shinhan BNP Paribas Asset Management

2011-2013 Deputy President, Shinhan Bank

Heo Young Taeg

Date of Birth August 13, 1961

Current Position Deputy President & Chief Management Officer (CMO),
Shinhan Financial Group

Education B.A. in Business Administration, Korea University

Main Work Experience

2021-Current Deputy President & CMO, Shinhan Financial Group

2019-2020 CEO, Shinhan Capital

2016-2018 Head of Global Business, Shinhan Bank

Jang Dong-ki

Date of Birth January 2, 1964

Current Position Deputy President & Head of Global Markets and
Securities (GMS), Shinhan Financial Group

Education B.A. in Economics, Seoul National University

Main Work Experience

2019-Current Deputy President & Head of GMS,
Shinhan Financial Group

2018-2019 Deputy President & CFO, Shinhan Financial Group

An Hyo Ryul

Date of Birth May 26, 1965
Current Position Deputy President & Head of Wealth Management (WM), Shinhan Financial Group
Education B.A. in Business Administration, Korea University
Main Work Experience
 2021–Current Deputy President & Head of WM, Shinhan Financial Group
 2020–2021 Executive Director & Head of Retirement Pension, Shinhan Financial Group
 2018–2020 Head of Management Planning and Consumer Protection, Shinhan Bank

Wang Ho-min

Date of Birth March 4, 1964
Current Position Deputy President & Chief Compliance Officer (CCO), Shinhan Financial Group
Education B.A. in Law, Hankuk University of Foreign Studies
Main Work Experience
 2019–Current Executive Director & CCO, Shinhan Financial Group
 2017–2019 General Manager of Jamsil-nam Branch, Shinhan Bank

Ahn Jun Sik

Date of Birth May 1, 1965
Current Position Deputy President & Chief Public Relation Officer (CPRO), Shinhan Financial Group
Education B.A. in Economics, Pusan National University
Main Work Experience
 2021–Current Deputy President & CPRO, Shinhan Financial Group
 2019–2020 Head of Seocho Division, Shinhan Bank

Lee Young Jong

Date of Birth February 7, 1966
Current Position Deputy President & Head of Retirement Pension, Shinhan Financial Group
Education B.A. in Business Administration, Seoul National University
Main Work Experience
 2022–Current Deputy President & Head of Retirement Pension, Shinhan Financial Group
 2021–2022 Chief Strategic Officer (CSO), Shinhan Life Insurance
 2019–2021 Deputy President, OrangeLife Insurance

Lee Een-Kyoon

Date of Birth April 1, 1967
Current Position Deputy President & Chief Operation Officer (COO), Shinhan Financial Group
Education B.A. in English Literature, Hanyang University
Main Work Experience
 2019–Current Executive Director & COO, Shinhan Financial Group
 2017–2019 Head of Management Support Team, Shinhan Financial Group

Jung Keun Soo

Date of Birth April 11, 1966
Current Position Deputy President & Head of Group and Global Investment Banking (GIB), Shinhan Financial Group
Education B.A. in Chinese Language & Literature, Korea University
Main Work Experience
 2021–Current Deputy President & Head of GIB, Shinhan Financial Group
 2019–2020 Managing Director, Investment & Finance Division, Shinhan Bank

Kim Soung Jo

Date of Birth January 18, 1967

Current Position Deputy President, Shinhan Financial Group

Education B.A. in Economics, Seoul National University

Main Work Experience

2021–Current Deputy President and Head of Audit Shinhan Financial Group

2018–2020 Head of Audit Team, Shinhan Financial Group

Bang Dong Kwon

Date of Birth February 10, 1966

Current Position Deputy President & Chief Risk Officer (CRO), Shinhan Financial Group

Education B.A. in English Literature, Sungkyunkwan University

Main Work Experience

2020–Current Deputy President & CRO, Shinhan Financial Group

2019–2020 General Manager, Risk Management Department, Shinhan Bank

Seo Seung Hyeon

Date of Birth March 4, 1967

Current Position Deputy President & Head of Global Business, Shinhan Financial Group

Education M.A. in Economics, Korea University
B.A. in Agricultural Economics, Korea University

Main Work Experience

2022–Current Deputy President & Head of Global Business, Shinhan Financial Group

2020–2021 Head of Global Business Division, Shinhan Bank

2018–2020 General Manager, Shinhan Bank London Branch

Lee Taekyung

Date of Birth May 30, 1966

Current Position Deputy President & Chief Financial Officer (CFO), Shinhan Financial Group

Education B.A. in Economics, Seoul National University

Main Work Experience

2022–Current Deputy President & CFO, Shinhan Financial Group

2021–2022 CEO, Shinhan Bank Vietnam

2019–2021 CEO, Shinhan Bank Cambodia

Kim Myoung Hee

Date of Birth January 16, 1968

Current Position Deputy President and Chief Digital Officer (CDO), Shinhan Financial Group

Education Ph. D. in Knowledge Consulting, Dankook University
M.A. in Management Information System (MIS), Sogang University

B.A. in Management Science, KAIST

Main Work Experience

2022–Current Deputy President and CDO, Shinhan Financial Group

2020–2021 CEO, Hancor MDS Inc.

2013–2017 Senior Vice President and Head of Solutions consulting and IoT Solutions Division, SK Telecom

2010–2013 Executive Director and Head of Service Management & Infra Technology Services, IBM Korea Inc.

Koh Seogheon

Date of Birth September 27, 1968
Current Position Executive Director & Chief Strategy and Sustainability Officer (CSSO), Shinhan Financial Group
Education Bachelor of Economics, Seoul National University
Main Work Experience
2022–Current Executive Director & CSSO, Shinhan Financial Group
2020–2021 Head of Business Management Division, Shinhan Financial Group
2019–2020 Head of Strategic Planning Team, Shinhan Financial Group

Kim Tae Youn

Date of Birth July 7, 1968
Current Position Executive Director & Head of Accounting Division, Shinhan Financial Group
Education B.A. in Economics, Yonsei University
Main Work Experience
2022–Current Executive Director & Head of Accounting Division, Shinhan Financial Group
2017–2021 Managing Director, head of Finance Management Team, Shinhan Financial Group
2009–2017 Deputy General Manager of Finance Management Team, Shinhan Financial Group

Lee Keon Hyok

Date of Birth July 17, 1963
Current Position Head of Future Strategy Research Institute, Shinhan Financial Group
Education M.A. and Ph. D. in Economics, London School of Economics (LSE)
Main Work Experience
2020–Current Head of Future Strategy Research Institute, Shinhan Financial Group
2018–2019 Senior Advisor, Kim & Chang Law Firm
2016–2018 Vice President, Samsung Economic Research Institute

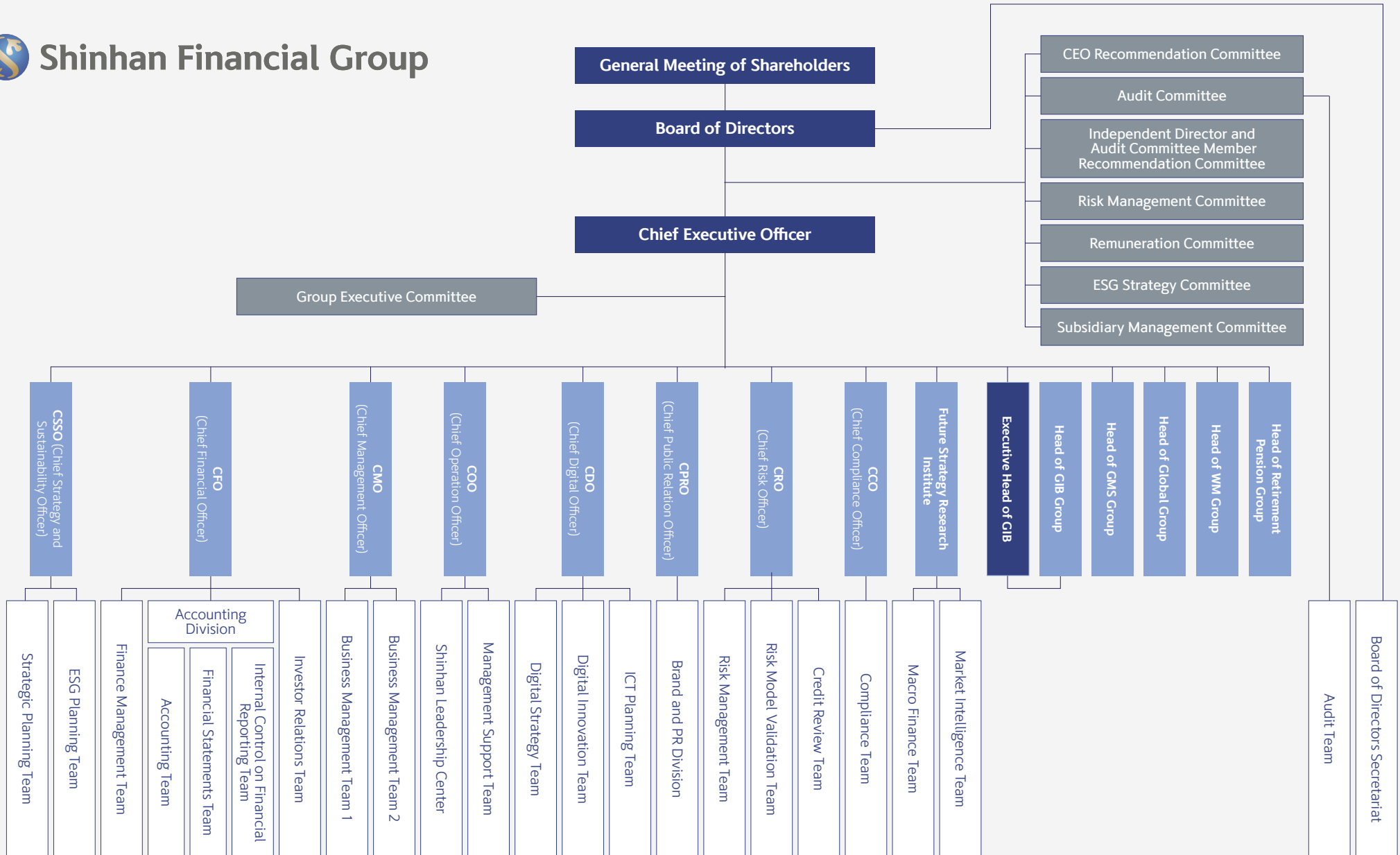

Shinhan Financial Group

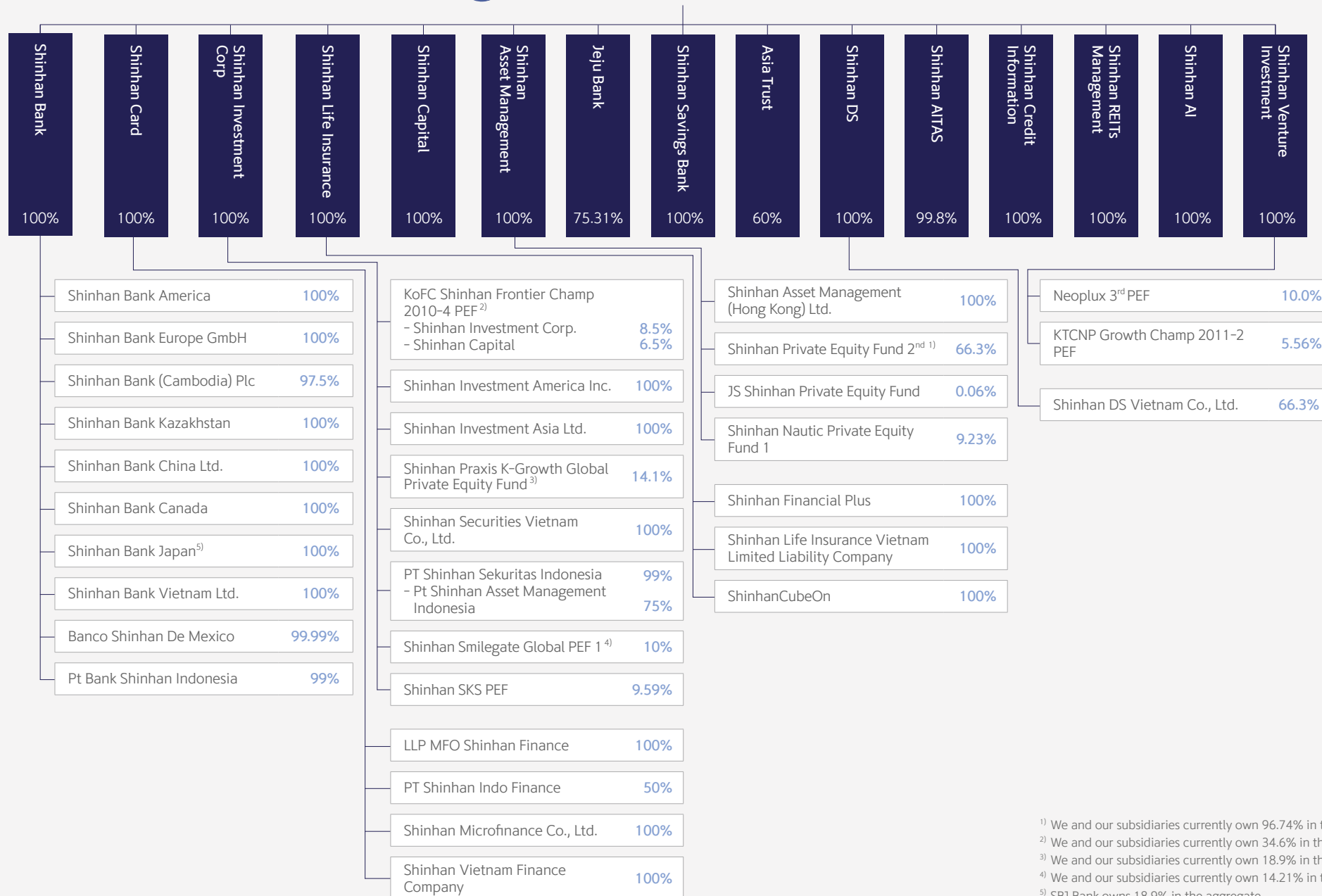

¹⁾ We and our subsidiaries currently own 96.74% in the aggregate.

²⁾ We and our subsidiaries currently own 34.6% in the aggregate.

³⁾ We and our subsidiaries currently own 18.9% in the aggregate.

⁴⁾ We and our subsidiaries currently own 14.21% in the aggregate.

⁵⁾ SBJ Bank owns 18.9% in the aggregate.

SHINHAN BANK

Country	Name	Telephone	Address
Japan	Shinhan Bank Japan	+81-3-6403-0505	The Mita Bellju Building 5F, 108-0014 5-36-7 Shiba, Minato-ku, Tokyo, Japan
China	Shinhan Bank (China)	+86-10-8529-0088	12th Fl. Zhongyu Plaza No.6, Workers' Stadium Road N., Chaoyang District, Beijing 100027, China
Vietnam	Shinhan Bank Vietnam	+84-8-3829-1581	Ground Floor, Mezzanine, 2nd & 3rd floor, Empress Tower, 138 – 142 Hai Ba Trung, Dakao Ward, District 1, Ho Chi Minh City, Vietnam
USA	Shinhan Bank America	+1-646-843-7300	475 Park Ave South 4th(5th) FL New York, NY 10016
Indonesia	PT Bank Shinhan Indonesia	+62-21-2975-1500	International Financial Centre Tower 2, Ground floor, Mezzanine, 30th and 31st floor, Jl. Jenderal Sudirman Kav.22-23 South Jakarta, Indonesia
Germany	Shinhan Bank Europe GmbH	+49-69-975-7130	An der Welle 7, 60322 Frankfurt am Main, Germany
Canada	Shinhan Bank Canada	+1-416-250-3500	5140 Yonge Street Suite 2300 Toronto, Ontario, M2N6L7, Canada
Cambodia	Shinhan Bank (Cambodia) Plc	+855-23-971-100	No.79 Kampuchea Krom, Sangkat Mororom, Khan 7 Makara, Phnom Penh, Cambodia
Kazakhstan	Shinhan Bank Kazakhstan	+7-727-356-9620	38 Dostyk ave. Almaty, 050010, Kazakhstan
Mexico	Banco Shinhan de Mexico	+52-55-6722-8000	Av. Paseo de la Reforma 250, Reforma Capital Torre B Cuauhtemoc, Juarez, 06600, Mexico D.F., Mexico
Hong Kong	Hong Kong Branch	+852-2867-0100	Unit 7703, International Commerce Centre, 1 Austin Road West, Kowloon, Hong Kong
USA	New York Branch	+1-212-371-8000	600 3rd Ave, 17th Floor, New York, NY10016, USA
UK	London Branch	+44-207-600-0606	6th Floor, 77 Gracechurch Street, London, EC3V 0AS. UK
Singapore	Singapore Branch	+65-6536-1144	1 George St. #15-03, Singapore 049145
India	Mumbai Branch	+91-22-6199-2000	Unit No 1, Peninsula Tower 1, Peninsula Corporate Park, G K Marg, Lower Parel, Mumbai, 400013, India
India	New Delhi Branch	+91-11-4500-4800	2nd & 3rd Floor, D-5, South Extension, Part-2, New Delhi
India	Kancheepuram Branch	+91-44-2714-3500	Survey No:69/4A1 B No.101A, Bangalore Highway Road, Thandalam Village, Kancheepuram, Tamilnadu, India 602105
India	Pune Branch	+91-20-3086-4800	Ground Floor, Red Building. Plot No.2, Galaxy Society, Boat Club Road, Pune, Maharashtra, India 411001
India	Ahmedabad Branch	+91-79-7117-0400	FF2&FF3, 1st Floor, Shapath V Building, Opp. Karnavati Club, S.G.Highway, Ahmedabad, Gujarat, India 380015
India	Ranga Reddy Branch	+91-40-6635-2000	SLN Terminus, 1st Floor, Survey No 133, Gachibowli, Serilingampally, Mandal, Ranga Reddy District, Telangana State, India 500032
Myanmar	Yangon Branch	+95-1-9345-170	No.192, 10th Floor, Myanmar Centre Tower 1, Kabaraye Pagoda Road, Bahan Township, Yangon, Myanmar
Australia	Sydney Branch	+61-2-9224-7901	Level 25, 52 Martin Place, Sydney, NSW 2000, Australia
Philippines	Manila Branch	+63-2-405-6300	21st Floor, RCBC Savings Bank Corporate Center (RSBCC), 26th & 25th Street, Bonifacio South, Bonifacio Global City, Taguig City, Manila, Philippines
UAE	Dubai Branch	+971-4-551-2820	S1204, Emirates Financial Tower, DIFC, P.O. Box 507001, Dubai, UAE
Uzbekistan	Shinhan Bank Uzbekistan Representative Office	+998-71-150-1184	Neworld Bldg. 3rd Fl., Oybek St. 22 Tashkent, Uzbekistan 100015
Hungary	Shinhan Bank Hungary Representative Office	+36-30-969-5829	1117 Budapest, Irinyi Jozsef utca 4-20, 225/1, Hungary

SHINHAN CARD

Country	Name	Telephone	Address
Indonesia	PT Shinhan Indo Finance	+62-21-857+9095	Wisma Indomobil 1, 10th Floor, Jl. Letjen M.T. Haryono Kav. 8, Jakarta 13330, Indonesia
Kazakhstan	LLP MFO Shinhan Finance	+7-727-355-2550	2nd Floor, 48 Auezov street, Almaty, Kazakhstan
Myanmar	Shinhan Microfinance Co., Ltd.	+95-94-5296-7837	No.206, Thiri Mingalar Street, East Ywama, Insein Township, Yangon, Myanmar
Vietnam	Shinhan Vietnam Finance Limited (SVFC)	+84-1900-5454 49	Units 2301-06 & 2311 23F, Saigon Trade Center, No. 37 Ton Duc Thang Street, Ben Nghe, District 1, Ho Chi Minh City, Vietnam
Myanmar	Shinhancard Co., LTD (Representative Office)	+95-9251890332	Level 3, Business Suite 03-08, No.1, Kaba Aye Pagoda Road Ward, Yankin Township, Yangon, Myanmar

SHINHAN INVESTMENT

Country	Name	Telephone	Address
Indonesia	PT. Shinhan Sekuritas Indonesia	+62-21-8086-9900	Equity Tower, 50th Floor, Jl. Jend. Sudirman No. Kav. 52-53, South Jakarta 12190, Indonesia
Hong Kong	Shinhan Investment Asia Ltd.	+852-3713-5301	Units 7705A, Level 77 International Commerce Center (ICC), 1 Austin Road West, Kowloon, Hong Kong
Vietnam	Shinhan Securities Vietnam Co., Ltd.	+84-28-6299-8000	22nd floor, Centec Tower, 72-74 Nguyen Thi Minh Khai, Phuong 6, District 3, Ho Chi Minh City, Vietnam
USA	Shinhan Investment America Inc.	+1-212-397-4000	1325 Avenue of the Americas #2002A, New York, NY 10019, USA
China	Shinhan Investment Shanghai Representative Office	+86-21-6194-6624	#3222, 32/F, One Lujiazui, 68 Yin Cheng Road, Pudong, Shanghai, China
Vietnam	Shinhan Investment Ho-Chi-Minh City Representative Office	+84-28-6287-8034	22nd Floor, Centec Tower, 72-74 Nguyen Thi Minh Khai, Phuong 6, District 3, Ho Chi Minh City, Vietnam
Indonesia	Shinhan Asset Management Indonesia	+62 21 3100078	Equity Tower, 50th Floor, Jl. Jend. Sudirman No. Kav. 52-53, South Jakarta 12190, Indonesia

SHINHAN LIFE INSURANCE

Country	Name	Telephone	Address
Vietnam	Shinhan Life Insurance Vietnam Limited Liability Company (SHLV)	+84-28-7300-9920	20th Floor, Friendship Tower, 31 Le Duan, Ben Nghe Ward, District 1, Ho Chi Minh City, Vietnam
UK	Shinhan Life Insurance London Office	+44-7494-712945	Level 30, The Leadenhall Building, 122 Leadenhall Street, London, EC3V 4AB, UK

SHINHAN ASSET MANAGEMENT

Country	Name	Telephone	Address
Hong Kong	Shinhan Asset Management (HK) Ltd.	+852-2525-9110	Unit 7702B, Level 77, International Commerce Centre, 1 Austin Road West Kowloon, Hong Kong

SHINHAN DS

Country	Name	Telephone	Address
Vietnam	Shinhan DS Vietnam Company Limited	+84-28-3823-7255	Room 201, 2nd Floor, Center Tower, 72-74 Nguyen Thi Minh Khai, Ward 6, District 3, Ho Chi Minh City, Vietnam
Indonesia	Shinhan DS Indonesia Office	+62-813-1532-3465	Gedung Equity Tower Lantai 8 Unit B Sudirman Central Business District (SCBD) lot 9, Jalan Jenderal Sudirman Kav. 52-53 Kelurahan Senayan, kecamatan Kebayoran Baru, Jakarta Selatan 12190, Indonesia



**SHINHAN FINANCIAL GROUP CO., LTD.
AND SUBSIDIARIES**

Consolidated Financial Statements

December 31, 2021 and 2020

(With Independent Auditors' Report Thereon)

Contents

	Page
Independent Auditors' Report	1
Consolidated Statements of Financial Position	5
Consolidated Statements of Comprehensive Income	7
Consolidated Statements of Changes in Equity	9
Consolidated Statements of Cash Flows	11
Notes to the Consolidated Financial Statements	14



Independent Auditor's Report

(English Translation of a Report Originally Issued in Korean)

To the Board of Directors and Shareholders of Shinhan Financial Group Co., Ltd.

Opinion

We have audited the accompanying consolidated financial statements of Shinhan Financial Group Co., Ltd. and its subsidiaries (collectively referred to as the "Group"), which comprise the consolidated statements of financial position as at December 31, 2021 and 2020, and the consolidated statements of comprehensive income, consolidated statements of changes in equity and consolidated statements of cash flows for the years then ended, and notes to the consolidated financial statements, including a summary of significant accounting policies.

In our opinion, the accompanying consolidated financial statements present fairly, in all material respects, the consolidated financial position of the Group as at December 31, 2021 and 2020, and its consolidated financial performance and its consolidated cash flows for the years then ended in accordance with International Financial Reporting Standards as adopted by the Republic of Korea (Korean IFRS).

Basis for Opinion

We conducted our audits in accordance with Korean Standards on Auditing. Our responsibilities under those standards are further described in the *Auditor's Responsibilities for the Audit of the Consolidated Financial Statements* section of our report. We are independent of the Group in accordance with the ethical requirements of the Republic of Korea that are relevant to our audit of the consolidated financial statements and we have fulfilled our other ethical responsibilities in accordance with the ethical requirements. We believe that the audit evidence we have obtained is sufficient and appropriate to provide a basis for our audit opinion.

Emphasis of Matter

Without qualifying our opinion, we draw attention to Note 4 and Note 49 of the financial statements. As explained in Notes 4 and 49, the rapid spread of the COVID-19 has had a negative impact on the global economy, which can result in an increase in expected credit losses, potential impairment of assets, and negatively affecting the Group's ability to generate revenue.

Key Audit Matters

Key audit matters are those matters that, in our professional judgment, were of most significance in our audit of the consolidated financial statements of the current period. These matters were addressed in the context of our audit of the consolidated financial statements as a whole, and in forming our opinion thereon, and we do not provide a separate opinion on these matters.

1. Expected Credit Losses on Loans Measured at Amortized Cost

Why it is determined to be a key audit matter:

The impairment guidance under Korean IFRS 1109 *Financial Instruments* requires determination of significant increases in credit risk and measurement of expected credit losses using forward-looking information and others. Accordingly, the Group developed a new measurement model utilizing various types of information, which requires a higher level of management's interpretation and judgment.

The Group measures expected credit losses on loans measured at amortized cost based on both individual and collective assessments. Individual assessment of expected credit losses is performed based on estimates of future forecast cash flow with a relatively high degree of management's estimates and judgments, and collective assessment of expected credit losses is involved with a variety and complex variable inputs and assumptions that requires management's estimates and judgments. Due to these facts, expected credit losses of loans measured at amortized costs are determined as a key audit matter.

As described in Note 12, loans measured at amortized cost subject to individual or collective assessments amount to ₩ 392,304,224 million, with allowances for credit losses of ₩ 3,167,068 million as of December 31, 2021.

How our audit addressed the key audit matter:

(1) Assessment of expected credit losses on an individual basis

We obtained an understanding and evaluated the processes and controls relating to the assessment of expected credit losses on an individual basis. In particular, we focused our effort on the assumptions used in estimating future cash flows. We evaluated whether management's estimation was reasonable and we assessed the key assumptions in the cash flow projection including growth rate of entities subject to individual assessment and collateral valuation. As part of these procedures, we assessed whether sales growth rate, operating income ratio, and assumptions on investment activities were consistent with historical operating performance and current market conditions. Furthermore, we assessed the appropriateness of collateral valuation by conducting our own research on recent property prices and engaged independent appraisal specialists in assessing reasonableness of appraisal reports, models and methodologies used by management.

(2) Assessment of expected credit losses on a collective basis

We obtained an understanding and evaluated the processes and controls relating to management's calculation of expected credit losses on a collective basis in accordance with impairment requirements under Korean IFRS 1109 *Financial Instruments*. As explained in Note 3(8), management assesses credit ratings to recognize lifetime expected credit losses on loans with significant increase in credit risk and impaired loans. Other than these cases, management recognizes 12-months of expected credit losses. To calculate all expected credit losses, management has applied forward-looking information, possible multiple scenarios, probability of default, loss given default and other assumptions estimated through its internal procedures and controls implemented for various assumptions.

We assessed the design and operating effectiveness of controls relating to credit ratings that reasonably reflect both qualitative and quantitative information. Our testing over the accuracy and reliability of the information included agreeing qualitative and quantitative information with relevant evidence.

We reviewed the appropriateness of management policies and procedures to determine significant increases in credit risk, and tested reasonableness of expected credit loss model applied by each of the three stages(Stage 1, 2 and 3) depending on how significantly credit risk was increased.

Our audit effort involved risk specialists in verifying the reasonability and possibility of forward-looking information and multiple scenarios produced by management. Also, our audit involved risk specialists to statistically analyze the correlation between forward-looking information and probability of default or loss given default. We assessed the appropriateness of methodologies for adjusting the probability of default to reflect forward-looking information on estimation of expected credit losses. We further tested the reasonableness and mathematical accuracy of the information through recalculation and inspection of supporting data.

We reviewed the methodologies used by management to verify that probability of default and loss given default were calibrated using sufficient and reasonable historical data. We determined that the default and loss data used were appropriately gathered and applied in accordance with internal control procedures. In addition, we assessed reasonableness and accuracy of probability of default and loss given default through procedures including recalculation, and evaluated management's default and loss data by agreeing them with relevant evidence.

2. Valuation of Over-The-Counter Derivatives Classified as Level 3 Subject to Internal Valuation Models

Why it is determined to be a key audit matter :

Fair value of large portion of over-the-counter derivatives in the consolidated financial statements is calculated through the use of an internally developed valuation system. Judgment is required in estimating the fair value of these derivatives held by Shinhan Investment Co., Ltd. in determining appropriate models, assumptions and inputs. Given the complexity of estimation and the extent of judgment involved in valuing these over-the-counter derivatives, we considered this to be a key audit matter. Over-the-counter derivatives of Shinhan Investment Co., Ltd. subject to fair value measurement are financial liabilities designated as fair value through profit or loss related to derivative linked securities and financial assets at fair value through profit or loss(See Note 4(5)) that amount to ₩ 8,376,316 million as of December 31, 2021.

How our audit addressed the key audit matter :

We obtained an understanding and evaluated processes and controls in relation to fair value measurement. Our focus was particularly on the accuracy of underlying transaction data used and mathematical calculation in accordance with management's internal valuation methodologies.

We assessed design and tested operating effectiveness of controls over accuracy and completeness of key inputs such as underlying transaction data (notional amount, interest rate, maturity etc.) used in management's determination of estimated fair value. We tested transaction data used in the valuation by examining supporting evidence including contracts and trade confirmations.

We also tested the controls over periodic verification of management's internal valuation system, verification of input data, and recalculation of output data to ensure the accuracy of over-the-counter derivative valuation. We involved our derivative valuation specialist to independently estimate fair values utilizing independent valuation models and variables to see if management's valuation is outside our ranges.

Other Matter

Auditing standards and their application in practice vary among countries. The procedures and practices used in the Republic of Korea to audit such consolidated financial statements may differ from those generally accepted and applied in other countries.

Responsibilities of Management and Those Charged with Governance for the Consolidated Financial Statements

Management is responsible for the preparation and fair presentation of the consolidated financial statements in accordance with Korean IFRS, and for such internal control as management determines is necessary to enable the preparation of consolidated financial statements that are free from material misstatement, whether due to fraud or error.

In preparing the consolidated financial statements, management is responsible for assessing the Group's ability to continue as a going concern, disclosing, as applicable, matters related to going concern and using the going concern basis of accounting unless management either intends to liquidate the Group or to cease operations.

Those charged with governance are responsible for overseeing the Group's financial reporting process.

Auditor's Responsibilities for the Audit of the Consolidated Financial Statements

Our objectives are to obtain reasonable assurance about whether the consolidated financial statements as a whole are free from material misstatement, whether due to fraud or error, and to issue an auditor's report that includes our opinion. Reasonable assurance is a high level of assurance, but is not a guarantee that an audit conducted in accordance with Korean Standards on Auditing will always detect a material misstatement when it exists. Misstatements can arise from fraud or error and are considered material if, individually or in the aggregate, they could reasonably be expected to influence the economic decisions of users taken on the basis of these consolidated financial statements.

As part of an audit in accordance with Korean Standards on Auditing, we exercise professional judgment and maintain professional skepticism throughout the audit. We also:

- Identify and assess the risks of material misstatement of the consolidated financial statements, whether due to fraud or error, design and perform audit procedures responsive to those risks, and obtain audit evidence that is sufficient and appropriate to provide a basis for our opinion. The risk of not detecting a material misstatement resulting from fraud is higher than for one resulting from error, as fraud may involve collusion, forgery, intentional omissions, misrepresentations, or the override of internal control.
- Obtain an understanding of internal control relevant to the audit in order to design audit procedures that are appropriate in the circumstances, but not for the purpose of expressing an opinion on the effectiveness of the entity's internal control.
- Evaluate the appropriateness of accounting policies used and the reasonableness of accounting estimates and related disclosures made by management.

- Conclude on the appropriateness of management's use of the going concern basis of accounting and, based on the audit evidence obtained, whether a material uncertainty exists related to events or conditions that may cast significant doubt on the Group's ability to continue as a going concern. If we conclude that a material uncertainty exists, we are required to draw attention in our auditor's report to the related disclosures in the consolidated financial statements or, if such disclosures are inadequate, to modify our opinion. Our conclusions are based on the audit evidence obtained up to the date of our auditor's report. However, future events or conditions may cause the Group to cease to continue as a going concern.
- Evaluate the overall presentation, structure and content of the consolidated financial statements, including the disclosures, and whether the consolidated financial statements represent the underlying transactions and events in a manner that achieves fair presentation.
- Obtain sufficient appropriate audit evidence regarding the financial information of the entities or business activities within the Group to express an opinion on the consolidated financial statements. We are responsible for the direction, supervision and performance of the Group audit. We remain solely responsible for our audit opinion.

We communicate with those charged with governance regarding, among other matters, the planned scope and timing of the audit and significant audit findings, including any significant deficiencies in internal control that we identify during our audit.

We also provide those charged with governance with a statement that we have complied with relevant ethical requirements regarding independence, and to communicate with them all relationships and other matters that may reasonably be thought to bear on our independence, and where applicable, related safeguards.

From the matters communicated with those charged with governance, we determine those matters that were of most significance in the audit of the consolidated financial statements of the current period and are therefore the key audit matters. We describe these matters in our auditor's report unless law or regulation precludes public disclosure about the matter or when, in extremely rare circumstances, we determine that a matter should not be communicated in our report because the adverse consequences of doing so would reasonably be expected to outweigh the public interest benefits of such communication.

The engagement partner on the audit resulting in this independent auditor's report is Sungeun Jin, Certified Public Accountant.

/s/ Samil PricewaterhouseCoopers
Seoul, Korea
March 3, 2022

<p>This report is effective as of March 3, 2022, the audit report date. Certain subsequent events or circumstances, which may occur between the audit report date and the time of reading this report, could have a material impact on the accompanying consolidated financial statements and notes thereto. Accordingly, the readers of the audit report should understand that there is a possibility that the above audit report may have to be revised to reflect the impact of such subsequent events or circumstances, if any.</p>

SHINHAN FINANCIAL GROUP CO., LTD. AND SUBSIDIARIES

Consolidated Statements of Financial Position

As of December 31, 2021 and 2020

(In millions of won)

	<u>Note</u>	<u>2021</u>	<u>2020</u>
Assets			
Cash and due from banks at amortized cost	4, 8, 12, 19	₩ 28,453,404	33,410,542
Financial assets at fair value through profit or loss	4, 9, 19	62,403,759	59,091,403
Derivative assets	4, 10	3,799,189	5,633,915
Securities at fair value through other comprehensive income	4, 11, 19	64,838,323	58,316,112
Securities at amortized cost	4, 11, 19	49,930,076	47,282,623
Loans at amortized cost	4, 12	389,137,156	356,221,519
Property and equipment, net	13, 18, 19	4,046,164	3,989,697
Intangible assets	14	5,644,782	5,480,619
Investments in associates	15	2,913,745	2,657,768
Current tax receivable		15,159	51,894
Deferred tax assets	41	134,854	215,345
Investment property	16	675,391	615,235
Net defined benefit assets	25	142,020	18,374
Other assets	4, 12, 17, 19	35,973,754	32,194,666
Assets held for sale		44,409	54,392
Total assets		<u>₩ 648,152,185</u>	<u>605,234,104</u>

SHINHAN FINANCIAL GROUP CO., LTD. AND SUBSIDIARIES
Consolidated Statements of Financial Position (Continued)

As of December 31, 2021 and 2020

<i>(In millions of won)</i>	<u>Note</u>		<u>2021</u>	<u>2020</u>
Liabilities				
Deposits	4, 20	₩	364,896,675	326,416,868
Financial liabilities at fair value through profit or loss	4, 21		1,369,225	1,436,694
Financial liabilities designated at fair value through profit or loss	4, 22		8,023,870	8,455,724
Derivative liabilities	4, 10		3,586,564	5,016,567
Borrowings	4, 23		43,167,065	41,594,064
Debt securities issued	4, 24		80,149,363	75,134,394
Net defined benefit liabilities	25		51,204	62,514
Provisions	26		1,166,856	804,736
Current tax payable			702,660	389,586
Deferred tax liabilities	41		175,947	579,656
Liabilities under insurance contracts	27		54,333,498	53,460,230
Other liabilities	4, 28		40,990,836	45,526,213
Total liabilities			<u>598,613,763</u>	<u>558,877,246</u>
Equity				
	29			
Capital stock			2,969,641	2,969,641
Hybrid bonds			3,334,531	2,179,934
Capital surplus			12,095,043	12,234,939
Capital adjustments			(664,429)	(687,935)
Accumulated other comprehensive loss			(984,936)	(404,181)
Retained earnings			30,541,300	27,777,169
Total equity attributable to equity holders of Shinhan Financial Group Co., Ltd.			<u>47,291,150</u>	<u>44,069,567</u>
Non-controlling interests			2,247,272	2,287,291
Total equity			<u>49,538,422</u>	<u>46,356,858</u>
Total liabilities and equity		₩	<u>648,152,185</u>	<u>605,234,104</u>

See accompanying notes to the consolidated financial statements.

SHINHAN FINANCIAL GROUP CO., LTD. AND SUBSIDIARIES

Consolidated Statements of Comprehensive Income

For the years ended December 31, 2021 and 2020

(In millions of won)

	Note	2021	2020
Interest income			
Financial assets at fair value through other comprehensive income and at amortized cost	₩	14,027,418	13,943,159
Financial assets at fair value through profit or loss		696,812	830,837
		14,724,230	14,773,996
Interest expense		(3,954,905)	(4,891,296)
Net interest income	31	10,769,325	9,882,700
Fees and commission income			
Fees and commission income		4,139,885	3,814,474
Fees and commission expense		(1,464,888)	(1,431,541)
Net fees and commission income	32	2,674,997	2,382,933
Insurance income			
Insurance income		6,484,523	7,247,753
Insurance expenses		(7,259,909)	(7,851,685)
Net insurance expenses	27	(775,386)	(603,932)
Dividend income			
Dividend income	33	124,531	97,956
Net gain on financial instruments at fair value through profit or loss			
Net gain on financial instruments at fair value through profit or loss	34	1,103,631	272,830
Net gain (loss) on financial instruments at fair value through profit or loss (overlay approach)	9	43,003	(136,255)
Net gain (loss) on financial instruments designated at fair value through profit or loss	35	(88,301)	198,239
Net gain on foreign currency transaction		222,819	526,615
Net gain on disposal of securities at fair value through other comprehensive income	11	85,596	273,793
Net loss on disposal of securities at amortized cost	11	(319)	(25)
Provision for allowance for credit loss	36	(974,685)	(1,382,179)
General and administrative expenses	37	(5,743,088)	(5,212,473)
Other operating expenses, net	39	(1,490,027)	(1,370,466)
Operating income		5,952,096	4,929,736
Equity method income			
Equity method income	15	158,600	159,533
Other non-operating expense, net	40	(527,032)	(335,398)
Profit before income taxes		5,583,664	4,753,871
Income tax expense			
Income tax expense	41	1,471,036	1,255,795
Profit for the year	₩	4,112,628	3,498,076

SHINHAN FINANCIAL GROUP CO., LTD. AND SUBSIDIARIES
Consolidated Statements of Comprehensive Income (Continued)

For the years ended December 31, 2021 and 2020

<i>(In millions of won, except earnings per share data)</i>	Note	2021	2020
Other comprehensive income for the year, net of income tax	29		
Items that are or may be reclassified to profit or loss:			
Loss on securities at fair value through other comprehensive income	₩	(879,671)	(86,784)
Gain (loss) on financial instruments at fair value through profit or loss (overlay approach)	9	(20,098)	90,298
Equity in other comprehensive income (loss) of associates		2,748	(3,318)
Foreign currency translation adjustments for foreign operations		252,308	(161,365)
Net change in unrealized fair value of cash flow hedges		21,700	(14,460)
Other comprehensive income (loss) of separate account		(41,273)	3,884
		<u>(664,286)</u>	<u>(171,745)</u>
Items that will never be reclassified to profit or loss:			
Remeasurements of the defined benefit liability		43,277	15,812
Equity in other comprehensive loss of associates		(2)	(10)
Valuation gain on securities at fair value through other comprehensive income		35,441	6,841
Loss on disposal of securities at fair value through other comprehensive income		(29,421)	(27,826)
Changes in own credit risk on financial liabilities designated at fair value through profit of loss		(2,798)	3,084
		<u>46,497</u>	<u>(2,099)</u>
Total other comprehensive income, net of income tax		<u>(617,789)</u>	<u>(173,844)</u>
Total comprehensive income for the year	₩	<u>3,494,839</u>	<u>3,324,232</u>
Profit attributable to:			
Equity holders of Shinhan Financial Group Co., Ltd.	29, 42 ₩	4,019,254	3,414,595
Non-controlling interests		93,374	83,481
	₩	<u>4,112,628</u>	<u>3,498,076</u>
Total comprehensive income attributable to:			
Equity holders of Shinhan Financial Group Co., Ltd.	₩	3,402,925	3,242,745
Non-controlling interests		91,914	81,487
	₩	<u>3,494,839</u>	<u>3,324,232</u>
Earnings per share:	29, 42		
Basic and diluted earnings per share in won	₩	<u>7,308</u>	<u>6,654</u>

See accompanying notes to the consolidated financial statements.

SHINHAN FINANCIAL GROUP CO., LTD. AND SUBSIDIARIES

Consolidated Statements of Changes in Equity

For the years ended December 31, 2020

(In millions of won)

	Equity attributable to equity holders of Shinhan Financial Group Co., Ltd.								
	Capital stock	Hybrid bonds	Capital surplus	Capital adjustments	Accumulated other comprehensive income (loss)	Retained earnings	Sub-total	Non-controlling interests	Total
Balance at January 1, 2020	₩ 2,732,463	1,731,235	10,565,353	(1,116,770)	(260,156)	25,525,821	39,177,946	2,752,435	41,930,381
Total comprehensive income for the year									
Profit for the year	-	-	-	-	-	3,414,595	3,414,595	83,481	3,498,076
Other comprehensive income (loss), net of income tax:									
Loss on valuation and disposal of securities at fair value through other comprehensive income	-	-	-	-	(107,484)	-	(107,484)	(285)	(107,769)
Gain on financial instruments at fair value through profit or loss (overlay approach)	-	-	-	-	90,298	-	90,298	-	90,298
Equity in other comprehensive loss of associates	-	-	-	-	(3,328)	-	(3,328)	-	(3,328)
Foreign currency translation adjustments for foreign operations	-	-	-	-	(159,596)	-	(159,596)	(1,769)	(161,365)
Net change in unrealized fair value of cash flow hedges	-	-	-	-	(14,460)	-	(14,460)	-	(14,460)
Other comprehensive income of separate account	-	-	-	-	3,884	-	3,884	-	3,884
Remeasurements of defined benefit plans	-	-	-	-	15,752	-	15,752	60	15,812
Changes in own credit risk on financial liabilities designated at fair value through profit or loss	-	-	-	-	3,084	-	3,084	-	3,084
Total other comprehensive loss	-	-	-	-	(171,850)	-	(171,850)	(1,994)	(173,844)
Total comprehensive income(loss)	-	-	-	-	(171,850)	3,414,595	3,242,745	81,487	3,324,232
Other changes in equity									
Dividends	-	-	-	-	-	(883,929)	(883,929)	-	(883,929)
Dividends to hybrid bonds	-	-	-	-	-	(85,327)	(85,327)	-	(85,327)
Issuance of hybrid bonds	-	448,699	-	-	-	-	448,699	-	448,699
Paid-in capital increase	237,178	-	1,197,774	-	-	-	1,434,952	-	1,434,952
Acquisition of treasury stock(Note 29)	-	-	-	(150,467)	-	-	(150,467)	-	(150,467)
Disposal of treasury stock(Note 29)	-	-	-	451,809	-	-	451,809	-	451,809
Retirement of treasury stock(Note 29)	-	-	-	150,000	-	(150,025)	(25)	-	(25)
Change in other capital adjustments	-	-	471,812	(22,507)	-	(16,141)	433,164	-	433,164
Change in other non-controlling interests	-	-	-	-	-	-	-	(546,631)	(546,631)
	237,178	448,699	1,669,586	428,835	-	(1,135,422)	1,648,876	(546,631)	1,102,245
Reclassification of OCI retained earnings	-	-	-	-	27,825	(27,825)	-	-	-
Balance at December 31, 2020	₩ 2,969,641	2,179,934	12,234,939	(687,935)	(404,181)	27,777,169	44,069,567	2,287,291	46,356,858

See accompanying notes to the consolidated financial statements.

SHINHAN FINANCIAL GROUP CO., LTD. AND SUBSIDIARIES

Consolidated Statements of Changes in Equity (Continued)

For the years ended December 31, 2021

(In millions of won)

	Equity attributable to equity holders of Shinhan Financial Group Co., Ltd.									
	Capital stock	Hybrid bonds	Capital surplus	Capital adjustments	Accumulated other comprehensive income (loss)	Retained earnings	Sub-total	Non-controlling interests	Total	
Balance at January 1, 2021	₩	2,969,641	2,179,934	12,234,939	(687,935)	(404,181)	27,777,169	44,069,567	2,287,291	46,356,858
Total comprehensive income for the year										
Profit for the year		-	-	-	-	4,019,254	4,019,254	93,374		4,112,628
Other comprehensive income (loss), net of income tax:										
Loss on valuation and disposal of securities at fair value through other comprehensive income		-	-	-	(871,104)	-	(871,104)	(2,547)		(873,651)
Gain on financial instruments at fair value through profit or loss (overlay approach)		-	-	-	(20,098)	-	(20,098)	-		(20,098)
Equity in other comprehensive income of associates		-	-	-	2,746	-	2,746	-		2,746
Foreign currency translation adjustments for foreign operations		-	-	-	251,842	-	251,842	466		252,308
Net change in unrealized fair value of cash flow hedges		-	-	-	21,700	-	21,700	-		21,700
Other comprehensive income of separate account		-	-	-	(41,273)	-	(41,273)	-		(41,273)
Remeasurements of defined benefit plans		-	-	-	42,656	-	42,656	621		43,277
Changes in own credit risk on financial liabilities designated at fair value through profit or loss		-	-	-	(2,798)	-	(2,798)	-		(2,798)
Total other comprehensive loss		-	-	-	(616,329)	-	(616,329)	(1,460)		(617,789)
Total comprehensive income(loss)		-	-	-	(616,329)	4,019,254	3,402,925	91,914		3,494,839
Other changes in equity										
Dividends		-	-	-	-	(803,838)	(803,838)	-		(803,838)
Interim dividends		-	-	-	-	(299,082)	(299,082)	-		(299,082)
Dividends to hybrid bonds		-	-	-	-	(116,388)	(116,388)	-		(116,388)
Issuance of hybrid bonds		-	1,154,597	-	-	-	1,154,597	-		1,154,597
Acquisition of treasury stock (Note 29)		-	-	-	(79)	-	(79)	-		(79)
Disposal of treasury stock (Note 29)		-	-	-	23,589	-	23,589	-		23,589
Change in other capital adjustments		-	-	(105)	(4)	(241)	(350)	-		(350)
Change in other non-controlling interests		-	-	(139,791)	-	-	(139,791)	(131,933)		(271,724)
		-	1,154,597	(139,896)	23,506	(1,219,549)	(181,342)	(131,933)		(313,275)
Reclassification of OCI retained earnings		-	-	-	-	35,574	(35,574)	-		-
Balance at December 31, 2021	₩	2,969,641	3,334,531	12,095,043	(664,429)	(984,936)	30,541,300	47,291,150	2,247,272	49,538,422

See accompanying notes to the consolidated financial statements

SHINHAN FINANCIAL GROUP CO., LTD. AND SUBSIDIARIES

Consolidated Statements of Cash Flows

For the years ended December 31, 2021 and 2020

<i>(In millions of won)</i>	<u>Note</u>	<u>2021</u>	<u>2020</u>
Cash flows from operating activities			
Profit before income taxes	₩	5,583,664	4,753,871
Adjustments for:			
Interest income	31	(14,724,230)	(14,773,996)
Interest expense	31	3,954,905	4,891,296
Dividend income	33	(124,531)	(97,956)
Net fees and commission expense	32	124,486	187,304
Net insurance loss	27	1,356,064	1,726,150
Net loss (gain) on financial instruments at fair value through profit or loss	34	(174,279)	136,191
Net loss (gain) on derivatives	10	64,128	(245,681)
Net loss (gain) on financial instruments at fair value through profit or loss (overlay approach)	9	(43,003)	136,255
Net gain on foreign currency translation		(21,130)	(232,723)
Net gain on financial instruments designated at fair value through profit or loss	35	(423,914)	(241,066)
Net gain on disposal of securities at fair value through other comprehensive income	11	(85,596)	(273,793)
Net loss on disposal of securities at amortized cost	11	319	25
Provision for allowance for credit loss	36	974,685	1,382,179
Employee benefit	25	221,259	175,539
Depreciation and other amortization	37	902,692	768,488
Other operating expense	39	457,359	202,178
Equity method income, net	15	(158,600)	(159,533)
Other non-operating expense	40	447,138	153,360
		<u>(7,252,248)</u>	<u>(6,265,783)</u>
Changes in assets and liabilities:			
Due from banks at amortized cost		9,570,696	(4,915,143)
Securities at fair value through profit or loss		(2,934,113)	(7,088,599)
Due from banks at fair value through profit or loss		92,944	862,047
Loans at fair value through profit or loss		341,140	132,172
Financial instruments designated at fair value through profit or loss		(9,466)	(708,627)
Derivative instruments		14,548	(65,288)
Loans at amortized cost		(28,740,535)	(32,897,127)
Other assets		(6,920,943)	(7,866,826)

SHINHAN FINANCIAL GROUP CO., LTD. AND SUBSIDIARIES

Consolidated Statements of Cash Flows (Continued)

For the years ended December 31, 2021 and 2020

<i>(In millions of won)</i>	<u>Note</u>	<u>2021</u>	<u>2020</u>
Deposits	₩	36,948,828	33,139,123
Liabilities for defined benefit obligations		(261,750)	(243,428)
Provisions		(25,526)	51,567
Other liabilities		(4,489,460)	8,503,803
		<u>3,586,363</u>	<u>(11,096,326)</u>
Income taxes paid		(1,149,965)	(1,184,910)
Interest received		14,325,392	14,570,884
Interest paid		(4,114,027)	(5,267,781)
Dividends received		100,936	80,728
Net cash inflow (outflow) from operating activities		<u>11,080,115</u>	<u>(4,409,317)</u>
Cash flows from investing activities			
Decrease in financial instruments at fair value through profit or loss		4,362,417	4,537,421
Increase in financial instruments at fair value through profit or loss		(5,409,361)	(4,982,663)
Proceeds from disposal of securities at fair value through other comprehensive income		29,991,033	53,048,284
Acquisition of securities at fair value through other comprehensive income		(37,575,878)	(52,657,353)
Proceeds from disposal of securities at amortized cost		5,203,156	5,923,611
Acquisition of securities at amortized cost		(7,343,501)	(7,645,000)
Proceeds from disposal of property and equipment	13, 40	20,068	248,037
Acquisition of property and equipment	13	(334,874)	(279,654)
Proceeds from disposal of intangible assets	14, 40	15,867	5,298
Acquisition of intangible assets	14	(555,340)	(362,415)
Proceeds from disposal of investments in associates	15	357,401	266,322
Acquisition of investments in associates	15	(588,827)	(776,799)
Proceeds from disposal of investment property	16, 40	276	113,038
Acquisition of investment property	16	(8,292)	(243,806)
Proceeds from disposal of assets held for sale		47,792	2,048
Change in other assets		(220,636)	11,233
Proceeds from settlement of hedging derivative financial instruments		61,502	25,722
Payment of settlement of hedging derivative financial instruments		(53,313)	(186,169)
Net cash flow from business combination	47	-	(73,081)
Net cash outflow from investing activities		<u>(12,030,510)</u>	<u>(3,025,926)</u>

SHINHAN FINANCIAL GROUP CO., LTD. AND SUBSIDIARIES
Consolidated Statements of Cash Flows (Continued)
For the years ended December 31, 2021 and 2020

<i>(In millions of won)</i>	<u>Note</u>	<u>2021</u>	<u>2020</u>
Cash flows from financing activities			
Issuance of hybrid bonds	₩	1,154,597	448,698
Net increase in borrowings		849,212	7,465,106
Proceeds from debt securities issued		28,561,082	21,480,455
Repayments of debt securities issued		(24,143,252)	(21,508,827)
Change in other liabilities		83,067	(30,526)
Dividends paid		(1,218,761)	(968,847)
Proceeds from settlement of hedging derivative financial instruments		1,223,033	851,381
Payment of settlement of hedging derivative financial instruments		(1,210,366)	(807,705)
Acquisition of treasury stock		(79)	(150,182)
Disposition and redemption of treasury stock		23,588	161,863
Increase(decrease) in non-controlling interests		(84,998)	566,673
Redemption of lease liabilities		(275,273)	(781,867)
Paid-in capital increase		-	1,154,347
Payment of stock issuance costs		(105)	-
Net cash inflow from financing activities		<u>4,961,745</u>	<u>7,880,569</u>
Effect of exchange rate changes on cash and cash equivalents held		<u>109,553</u>	<u>(61,518)</u>
Increase in cash and cash equivalents		4,120,903	383,808
Cash and cash equivalents at beginning of year	44	<u>8,962,982</u>	<u>8,579,174</u>
Cash and cash equivalents at end of year	44	<u>₩ 13,083,885</u>	<u>8,962,982</u>

See accompanying notes to the consolidated financial statements.

SHINHAN FINANCIAL GROUP CO., LTD. AND SUBSIDIARIES

Notes to the Consolidated Financial Statements

December 31, 2021 and 2020

1. Reporting entity

Shinhan Financial Group Co., Ltd., the controlling company, and its subsidiaries included in consolidation (collectively the “Group”) are summarized as follows:

(a) Controlling company

Shinhan Financial Group Co., Ltd. (the “Shinhan Financial Group” or the “Company”), the controlling company, is incorporated on September 1, 2001 for the main purposes of controlling, managing and funding Shinhan Bank, Shinhan Securities Co., Ltd., Shinhan Capital Co., Ltd. and Shinhan BNP Asset Management Co., Ltd. by way of share transfers. The total capital stock amounted to ₩1,461,721 million. Also, Shinhan Financial Group’s shares have been listed on the Korea Exchange since September 10, 2001 and Shinhan Financial Group’s American Depositary Shares have been registered with the Securities and Exchange Commission (SEC) and listed on the New York Stock Exchange since September 16, 2003.

(b) Ownership of Shinhan Financial Group and its major consolidated subsidiaries as of December 31, 2021 and 2020 are as follows:

Investor	Investee(*1)	Location	Date of financial information	Ownership (%)	
				December 31, 2021	December 31, 2020
Shinhan Financial Group Co., Ltd.	Shinhan Bank	Korea	December 31	100.0	100.0
"	Shinhan Card Co., Ltd.	"	"	100.0	100.0
"	Shinhan Investment Corp.	"	"	100.0	100.0
"	Shinhan Life Insurance Co., Ltd.(*2)	"	"	100.0	100.0
"	Orange Life Insurance Co., Ltd.(*2)	"	"	-	100.0
"	Shinhan Capital Co., Ltd.	"	"	100.0	100.0
"	Jeju Bank	"	"	75.3	75.3
"	Shinhan Credit Information Co., Ltd.	"	"	100.0	100.0
"	Shinhan Alternative Investment Management Inc.	"	"	100.0	100.0
"	Shinhan Asset Management Co., Ltd.(*3)	"	"	100.0	65.0
"	SHC Management Co., Ltd.	"	"	100.0	100.0
"	Shinhan DS	"	"	100.0	100.0
"	Shinhan Savings Bank	"	"	100.0	100.0
"	Asia Trust Co., Ltd.	"	"	60.0	60.0
"	Shinhan AITAS Co., Ltd.	"	"	99.8	99.8
"	Shinhan REITs Management Co., Ltd.	"	"	100.0	100.0
"	Shinhan AI Co., Ltd.	"	"	100.0	100.0
"	Shinhan Venture Investment Co., Ltd.(*4)	"	"	100.0	100.0
Shinhan Bank	Shinhan Bank America	USA	"	100.0	100.0
"	Shinhan Bank Europe GmbH	Germany	"	100.0	100.0
"	Shinhan Bank Cambodia	Cambodia	"	97.5	97.5
"	Shinhan Bank Kazakhstan Limited	Kazakhstan	"	100.0	100.0
"	Shinhan Bank Canada	Canada	"	100.0	100.0
"	Shinhan Bank (China) Limited	China	"	100.0	100.0
"	Shinhan Bank Japan	Japan	"	100.0	100.0
"	Shinhan Bank Vietnam Ltd	Vietnam	"	100.0	100.0
"	Banco Shinhan de Mexico	Mexico	"	99.9	99.9
"	PT Bank Shinhan Indonesia	Indonesia	"	99.0	99.0
Shinhan Bank Japan	SBJDNX	Japan	"	100.0	100.0
Shinhan Card Co., Ltd.	LLP MFO Shinhan Finance	Kazakhstan	"	100.0	100.0
"	PT. Shinhan Indo Finance	Indonesia	"	50.0+1 share	50.0+1 share
"	Shinhan Microfinance Co., Ltd.	Myanmar	"	100.0	100.0
"	Shinhan Vietnam Finance Co., Ltd.	Vietnam	"	100.0	100.0

SHINHAN FINANCIAL GROUP CO., LTD. AND SUBSIDIARIES

Notes to the Consolidated Financial Statements

December 31, 2021 and 2020

1. Reporting entity (continued)

(b) Ownership of Shinhan Financial Group and its major consolidated subsidiaries as of December 31, 2021 and 2020 are as follows (continued):

Investor	Investee(*1)	Location	Date of financial information	Ownership (%)	
				December 31, 2021	December 31, 2020
Shinhan Investment Corp.	Shinhan Investment Corp. USA Inc.	USA	December 31	100.0	100.0
"	Shinhan Investment Asia Ltd.	Hong Kong	"	100.0	100.0
"	SHINHAN SECURITIES VIETNAM CO., LTD.	Vietnam	"	100.0	100.0
"	PT. Shinhan Sekuritas Indonesia	Indonesia	"	99.0	99.0
PT Shinhan Sekuritas Indonesia	PT. Shinhan Asset Management Indonesia	"	"	75.0	75.0
Shinhan Life Insurance Co., Ltd.	Shinhan Financial Plus	Korea	"	100.0	100.0
"	Shinhan CubeOn Co., Ltd.(*5)	Korea	"	100.0	-
"	Shinhan Life Insurance Vietnam Co., Ltd.(*6)	Vietnam	"	100.0	-
Shinhan Asset Management Co., Ltd.	SHINHAN ASSET MGT HK, LIMITED(*7)	Hong Kong	"	100.0	100.0
Shinhan DS	SHINHAN DS VIETNAM CO., LTD.	Vietnam	"	100.0	100.0

(*1) Subsidiaries such as trust, beneficiary certificate, corporate restructuring fund and private equity fund which are not actually operating their own business are excluded.

(*2) Shinhan Life Insurance Co., Ltd. and Orange Life Insurance Co., Ltd. merged on July 1, 2021. The company name after the merger is Shinhan Life Insurance Co., Ltd.

(*3) The Group acquired additional shares of Shinhan BNPP Asset Management Co., Ltd. for the year ended December 31, 2021, and Shinhan BNPP Asset Management Co., Ltd. became a wholly owned subsidiary of the Group. Shinhan BNPP Asset Management Co., Ltd. changed its name to Shinhan Asset Management Co., Ltd.

(*4) For the year ended December 31, 2021, Neoplux Co., Ltd. changed its name to Shinhan Venture Investment Co., Ltd.

(*5) Newly invested subsidiaries subject to consolidation are included for the year ended December 31, 2021.

(*6) Newly invested subsidiaries subject to consolidation are included for the year ended December 31, 2021. Shinhan Insurance Vietnam Co., Ltd. changed its name to Shinhan Life Insurance Vietnam Co., Ltd.

(*7) For the year ended December 31, 2021, SHINHAN BNP ASSET MGT HK, LIMITED changed its name to SHINHAN ASSET MGT HK, LIMITED.

SHINHAN FINANCIAL GROUP CO., LTD. AND SUBSIDIARIES

Notes to the Consolidated Financial Statements

December 31, 2021 and 2020

1. Reporting entity (continued)

(c) Consolidated structured entities

Consolidated structured entities are as follows:

Category	Consolidated structured entities	Description
Trust	Shinhan Bank (including development trust) and 17 others	A trust is consolidated when the Group as a trustee is exposed to variable returns, if principle or interest amounts of the entrusted properties falls below guaranteed amount, the Group should compensate it, and the Group has the ability to affect those returns.
Asset-Backed Securitization	MPC Yulchon Green I and 225 others	An entity for asset backed securitization is consolidated when the Group has sole decision-making authority to dispose assets or change the conditions of the assets, and the Group is exposed to, or has rights to related variable returns by providing credit enhancement and purchases of subordinated securities.
Structured Financing	SHPE Holdings One Co., Ltd.	An entity established for structured financing relating to real estate, shipping, or mergers and acquisitions is consolidated, when the Group has the greatest credit to the entity, has sole decision-making authority of these Entities due to the entities default, and is exposed to, or has rights to related variable returns.
Investment Fund	KoFC Shinhan Frontier Champ 2010-4 PEF and 131 others	An investment fund is consolidated, when the Group manages or invests assets of the investment funds on behalf of other investors as a collective investor or a business executive, or has the ability to dismiss the manager of the investment funds, and is exposed to, or has rights to, the variable returns.

(*) The Group provides credit contribution (ABCP purchase agreements) of ₩7,457,666 million for the purpose of credit enhancement of structured companies.

SHINHAN FINANCIAL GROUP CO., LTD. AND SUBSIDIARIES

Notes to the Consolidated Financial Statements

December 31, 2021 and 2020

2. Basis of preparation

(a) Statement of compliance

The Group maintains its accounting records in Korean won and prepares statutory financial statements in the Korean language (Hangul) in accordance with International Financial Reporting Standards as adopted by the Republic of Korea (Korean IFRS). The accompanying consolidated financial statements have been condensed, restructured and translated into English from the Korean language financial statements.

The consolidated financial statements were authorized for issue by the Board of Directors on February 9, 2022, which will be submitted for approval to the stockholder's meeting to be held on March 24, 2022.

(b) Basis of measurement

The consolidated financial statements have been prepared on the historical cost basis, except for the following material items in the statement of financial position:

- derivative financial instruments measured at fair value
- financial instruments at fair value through profit or loss measured at fair value
- financial instruments at fair value through other comprehensive income measured at fair value
- liabilities for cash-settled share-based payment arrangements measured at fair value
- financial assets and liabilities designated as hedged items in a fair value hedge accounting of which changes in fair value attributable to the hedged risk recognized in profit or loss
- liabilities for defined benefit plans recognized at the net of the total present value of defined benefit obligations less the fair value of plan assets

(c) Functional and presentation currency

The respective financial statements of the Group entities are prepared in the functional currency of the respective economic environment in which the group entities operate. These consolidated financial statements are presented and reported in Korean won, which is the Controlling Company's functional currency and the currency of the primary economic environment in which the Group operates.

(d) Use of estimates and judgments

The preparation of the consolidated financial statements in conformity with K-IFRS requires management to make judgments, estimates and assumptions that affect the application of accounting policies and the reported amounts of assets, liabilities, income and expenses. If the estimates and assumptions based on management's best judgment as of December 31, 2021 are different from the actual environment, these estimates and actual results may be different.

Estimates and underlying assumptions are reviewed on an ongoing basis. Revisions to accounting estimates are recognized in the period in which the estimates are revised and in any future periods affected.

Information about critical judgments in applying accounting policies that have a significant effect on the amounts recognized in the consolidated financial statements and information about assumptions and estimation uncertainties that have a significant risk of resulting in a material adjustment within the next financial year are described in Note 5.

In preparing these consolidated financial statements, the significant judgments made by management in applying the Group's accounting policies and the key sources of estimation uncertainty are the same as those that applied to the consolidated financial statements as of and for the year ended December 31, 2020.

SHINHAN FINANCIAL GROUP CO., LTD. AND SUBSIDIARIES

Notes to the Consolidated Financial Statements

December 31, 2021 and 2020

2. **Basis of preparation (continued)**

(e) **Change in accounting policy**

Except for the following new standards, which have been applied from January 1, 2021, the accounting policies applied by the Group in these consolidated financial statements are the same as those applied by the Group in its consolidated financial statements as of and for the year ended December 31, 2020.

i) *K-IFRS No.1109, 'Financial Instruments', K-IFRS No.1039, 'Financial Instruments: Recognition and Measurement', K-IFRS No.1107, 'Financial Instruments: Disclosures', K-IFRS No.1104, 'Insurance Contracts' and K-IFRS No.1116, 'Leases' amended – Interest rate benchmark reform*

The effective interest rate, not the carrying value, is adjusted when replacing the interest rate index of a financial instrument measured at amortized cost in relation to the reform of the interest rate index. It includes exceptions, such as allowing hedge accounting to continue uninterrupted even if an interest rate indicator replacement occurs in a hedging relationship. The amendment does not have a significant impact on the consolidated financial statements.

Regarding the suspension of LIBOR interest rate calculation, the financial instruments that have not been converted to replaced interest rate benchmark among the LIBOR interest rates as of December 31, 2021 are as follows:

-Non-derivative financial assets

	Carrying Value			
	USD LIBOR(*2)	JPY LIBOR	EUR LIBOR	Other LIBORs
Due from banks and loans at amortized cost:				
Loans	₩ 2,768,972	207,660	49,642	122,104
Securities at fair value through other comprehensive income:				
Financial institution bonds	167,167	-	-	-
Corporate bonds and others	281,949	-	-	-
	449,116	-	-	-
Commitments and guarantee contracts(*1)	₩ 280,224	39,148	56,552	13,853

(*1) The commitments and guarantee contracts are in nominal amount.

(*2) The instruments that will be matured before the end of June 30, 2023 are excluded when USD LIBOR interest rate calculation is discontinued.

-Non-derivative financial liabilities

	Carrying Value			
	USD LIBOR(*1)	JPY LIBOR	EUR LIBOR	Other LIBORs
Financial liabilities at amortized cost:				
Deposits	₩ 200,000	-	-	-
Borrowings	347,420	-	-	-
Debt securities issued	986,871	-	-	-
	₩ 1,534,291	-	-	-

(*1) The instruments that will be matured before the end of June 30, 2023 are excluded when USD LIBOR interest rate calculation is discontinued.

SHINHAN FINANCIAL GROUP CO., LTD. AND SUBSIDIARIES

Notes to the Consolidated Financial Statements

December 31, 2021 and 2020

2. **Basis of preparation (continued)**

(e) **Change in accounting policy**

i) *K-IFRS No.1109, 'Financial Instruments' and K-IFRS No.1039, 'Financial Instruments: Recognition and Measurement' and K-IFRS No.1107, 'Financial Instruments: Disclosures' Revision' and K-IFRS No.1104, 'Insurance Contracts' K-IFRS No.1116, 'Leases' amended – Interest rate benchmark reform (continued)*

-Derivative

	Notional amount			
	USD LIBOR(*1)	JPY LIBOR	EUR LIBOR	Other LIBORs
Trading:				
Interest rates related	₩ 10,772,390	-	-	-
Foreign currency related	10,900,844	-	-	-
Equity related	268,243	-	-	-
Credit related	1,108	-	-	-
Others	379,360	-	-	-
	22,321,945	-	-	-
Hedge:				
Interest rates related	4,150,155	-	-	-
Foreign currency related	278,705	-	-	-
	₩ 4,428,860	-	-	-

(*1) The instruments that will be matured before the end of June 30, 2023 are excluded when LIBOR interest rate calculation is discontinued.

ii) *Amendments to K-IFRS No.1116 'Lease' - The practical expedient to COVID-19 related rent exception, discount or deferral*

The International Accounting Standards Board amended this Standard in March 2021. According to the amendment, the International Accounting Standards Board has extended the application of the practical expedient for reduction in lease payments where lessee may elect not to assess whether a rent concession occurring as a direct consequence of the COVID-19 pandemic is a lease modification, by one year. A lessee who chose to apply the application of the practical expedient will account consistently for changes in lease fees that not a lease change due to rent concession, in the manner prescribed by the amendments. However, no practical expedient under this amendment is provided to lessors. The practical expedient in this amendment applies only to rent concessions occurring as a direct consequence of the COVID-19 pandemic and only if all of the following conditions are met:

- The change in lease payments results in revised consideration for the lease that is substantially the same as, or less than, the consideration for the lease immediately preceding the change
- Any reduction in lease payments affects only payments originally due on or before June 30, 2022; and
- There is no substantive change to other terms and conditions of the lease.

The Group has applied the practical expedient that allows a lessee to choose not to assess whether a rent concession occurring as a direct consequence of the COVID-19 pandemic is a lease modification. The amount recognized in profit or loss is ₩47,589 million to reflect the change in lease payments arising from the same lease discount for the year ended December 31, 2021.

SHINHAN FINANCIAL GROUP CO., LTD. AND SUBSIDIARIES

Notes to the Consolidated Financial Statements

December 31, 2021 and 2020

3. Significant accounting policies

Significant accounting policies applied by the Group upon the preparation of consolidated financial statements under K-IFRS are described below, and consolidated financial statements for the year ended December 31, 2021 and comparative periods were prepared using the same accounting policy, except for changes in accounting policy described in the Note 2.

(a) Operating segments

The Group has divided the segments based on internal reports reviewed periodically by the top sales decision maker to make decisions about the resources allocated to the segments and evaluate their performance. There are six reporting segments as described in Note 7. The reporting segments are operated separately according to the nature of the goods and services provided and the organizational structure of the Group.

The segment reported to the Chief Executive Officer (“CEO”) includes items directly attributable to a segment as well as those that can be allocated on a reasonable basis.

It is the CEO’s responsibility to evaluate the resources to be distributed to the business and the performance of the business, and to make strategic decisions.

(b) Basis of consolidation

i) Subsidiaries

Subsidiaries are investees controlled by the Group. The Group controls an investee when it is exposed to, or has rights to, variable returns from its involvement with the investee and has the ability to affect those returns through its power over the investee. The financial statements of subsidiaries are included in the consolidated financial statements from the date that control commences until the date that control ceases.

If a member of the Group uses accounting policies other than those adopted in the consolidated financial statements for the same transactions and events in similar circumstances, appropriate adjustments are made to its financial statements in preparing the consolidated financial statements.

ii) Structured entity

The Group establishes or invests in various structured entities. It does not own shares directly or indirectly for these companies. Considering the terms and conditions of the arrangement in which the structured entity was established, the consolidated entity gains and losses from the operations of the structured entity. It is included in the consolidated entities if it is determined that it has the ability to direct the activities of a consolidated structured entity that can most significantly affect these gains and losses. The Group does not recognize any non-controlling interests as equity in relation to structured entities in the consolidated statements of financial position since the non-controlling interests in these entities are recognized as liabilities of the Group.

iii) Intra-group transactions eliminated on consolidation

Intra-group balances, transactions, and any unrealized income and expenses arising from intra-group transactions are eliminated in preparing the consolidated financial statements. Unrealized intra-group losses are recognized as expense if intra-group losses indicate an impairment that requires recognition in the consolidated financial statements.

SHINHAN FINANCIAL GROUP CO., LTD. AND SUBSIDIARIES

Notes to the Consolidated Financial Statements

December 31, 2021 and 2020

3. Significant accounting policies (continued)

(b) Basis of consolidation (continued)

iv) Non-controlling interests

Non-controlling interests in a subsidiary are accounted for separately from the parent's ownership interests in a subsidiary. Each component of net profit or loss and other comprehensive income is attributed to the owners of the parent and non-controlling interest holders, even when the non-controlling interests balance is reduced to below zero.

(c) Business combinations

i) Business combinations

A business combination is accounted for by applying the acquisition method, unless it is a combination involving entities or businesses under common control.

Each identifiable asset or liability is measured at its acquisition-date fair value except for below:

- Leases are required to be classified based on the contractual terms and other factors
- Only those contingent liabilities assumed in a business combination that are a present obligation and can be measured reliably are recognized
- Deferred tax assets or liabilities are recognized and measured in accordance with K-IFRS No.1012, '*Income Taxes*'
- Employee benefit arrangements are recognized and measured in accordance with K-IFRS No.1019, '*Employee Benefits*'
- Compensation assets are recognized and measured on the same basis as the items subject to compensation.
- Reacquired rights are measured in accordance with special provisions
- Liabilities or equity instruments related to share-based payment transactions are measured in accordance with the method in K-IFRS No.1102, '*Share-based Payment*'
- Non-current assets held for sale are measured at fair value less costs to sell in accordance with K-IFRS No.1105, '*Non-current Assets Held for Sale and Discontinued Operations*'

As of the acquisition date, non-controlling interests in the acquired are measured as the non-controlling interests' proportionate share of the acquirer's identifiable net assets.

The transfer consideration in a business combination is measured at fair value, which is calculated as the sum of the acquisition-date fair values of the assets transferred by the acquirer, the liabilities incurred by the acquirer to former owners of the acquired and the equity interests issued by the acquirer. However, any portion of the acquirer's share-based payment awards exchanged for awards held by the acquired employee that is included in transfer consideration in the business combination shall be measured in accordance with the method described above rather than at fair value.

Acquisition-related costs are costs the acquirer incurs to effect a business combination. Those costs include broker's fees; advisory, legal, accounting, valuation and other professional or consulting fees; general administrative costs, including the costs of maintaining an internal acquisitions department; and costs of registering and issuing debt and equity securities. Acquisition-related costs, other than those associated with the issue of debt or equity securities, which are recognized in accordance with K-IFRS No.1032 and 1109, are expensed in the periods in which the costs are incurred and the services are received.

SHINHAN FINANCIAL GROUP CO., LTD. AND SUBSIDIARIES

Notes to the Consolidated Financial Statements

December 31, 2021 and 2020

3. Significant accounting policies (continued)

(d) Investments in associates and joint ventures

An associate is an entity in which the Group has significant influence, but not control, over the entity's financial and operating policies. Significant influence is presumed to exist when the Group holds between 20 and 50 percent of the voting power of another entity.

A joint venture is a joint arrangement whereby the parties that have joint control of the arrangement have rights to the net assets of the arrangement. Joint control is the contractually agreed sharing of control of an arrangement, which exists only when decisions about the relevant activities require the unanimous consent of the parties sharing control.

The investment in an associate and a joint venture is initially recognized at cost, and the carrying value is increased or decreased to recognize the Group's share of the profit or loss and changes in equity of the associate and the joint venture after the date of acquisition. Intra-group balances and transactions, and any unrealized income and expenses arising from intra-group transactions, are eliminated the Group's stake in preparing the consolidated financial statements. Unrealized losses are also being derecognized unless the transaction provides evidence of an impairment of the transferred assets.

If an associate or a joint venture uses accounting policies different from those of the Group for transactions and events in similar circumstances, appropriate adjustments are made to its financial statements in applying the equity method.

When the carrying value of that interest, including any long-term investments, is reduced to nil, the recognition of further losses is discontinued except to the extent that the Group has an obligation or has to make payments on behalf of the investee for further losses.

(e) Cash and cash equivalents

The Group classifies cash balances, call deposits and highly liquid investment assets with original maturities of three months or less from the acquisition date that are easily converted into a fixed amount of cash, and are subject to an insignificant risk of changes in their fair value as cash and cash equivalents. Equity instruments are excluded from cash equivalents unless they are, in substance, cash equivalents, like in the case of preferred shares acquired within a short period of their maturity and with a specified redemption date.

SHINHAN FINANCIAL GROUP CO., LTD. AND SUBSIDIARIES

Notes to the Consolidated Financial Statements

December 31, 2021 and 2020

3. Significant accounting policies (continued)

(f) Non-derivative financial assets

Financial assets are recognized in the consolidated statement of financial position when the Group becomes a party to the contract. In addition, a standardized purchase or sale (a purchase or sale of a financial asset under a contract whose terms require delivery of the asset within the time frame established generally by regulation or convention in the market concerned) is recognized on the trade date.

A financial asset is measured initially at its fair value plus, for an item not at Fair Value Through Profit or Loss (“FVTPL”), transaction costs that are directly attributable to its acquisition of the financial asset. Transaction costs on the financial assets at FVTPL that are directly attributable to the acquisition are recognized in profit or loss as incurred.

i) Financial assets designated at FVTPL

Financial assets can be irrevocably designated as measured at FVTPL despite of classification standards stated below, if doing so eliminates or significantly reduces an accounting mismatch that would otherwise arise from measuring assets or liabilities or recognizing the gains or losses on them on different bases.

ii) Equity instruments

For the equity instruments that are not held for short-term trading, at initial recognition, the Group may make an irrevocable election to present subsequent changes in fair value in other comprehensive income. Equity instruments that are not classified as financial assets at Fair Value through Other Comprehensive Income (“FVOCI”) are classified as financial assets at FVTPL.

The Group subsequently measures all equity investments at fair value. Valuation gains or losses of the equity instruments that are classified as financial assets at FVOCI previously recognized as other comprehensive income is not reclassified as profit or loss on recognition. The Group recognizes dividends in profit or loss when the Group’s right to receive payments of the dividend is established.

Valuation gains or losses due to changes in fair value of the financial assets at FVTPL are recognized in the consolidated statement of comprehensive income gains or losses on financial assets at FVTPL. Impairment loss (reversal) on equity instruments at FVOCI is not recognized separately.

iii) Debt instruments

Subsequent measurement of debt instruments depends on the Group’s business model in which the asset is managed and the contractual cash flow characteristics of the asset. Debt instruments are classified as financial assets at amortized cost, at FVOCI, or at FVTPL. Debt instruments are reclassified only when the Group’s business model changes.

① Financial assets at amortized cost

Assets that are held within a business model whose objective is to hold assets to collect contractual cash flows where those cash flows represent solely payments of principal and interest are measured at amortized cost. A gain or loss on a financial asset measured at amortized cost that is not subject to a hedging relationship is recognized in profit or loss when the financial asset is derecognized or impaired. Interest income on the effective interest method is included in the ‘Interest income’ in the consolidated statement of comprehensive income.

SHINHAN FINANCIAL GROUP CO., LTD. AND SUBSIDIARIES

Notes to the Consolidated Financial Statements

December 31, 2021 and 2020

3. Significant accounting policies (continued)

(f) Non-derivative financial assets (continued)

② Financial assets at FVOCI

Assets that are held within a business model whose objective is achieved by both collecting contractual cash flows and selling financial assets and, where the assets' cash flows represent solely payments of principal and interest, are measured at FVOCI. Other than (reversal of) impairment losses, interest income, foreign exchange differences, gains or losses of the financial assets at FVOCI are recognized as other comprehensive income in equity. On removal, gains or losses accumulated in other comprehensive income are reclassified to profit or loss. The interest income on the effective interest method is included in the 'Interest income' in the consolidated statement of comprehensive income. Foreign exchange differences and impairment losses are included in the 'Net foreign currency transaction gain' and 'Provision for credit losses allowance' in the consolidated statement of comprehensive income, respectively.

③ Financial assets at FVTPL

Debt securities other than financial assets at amortized costs or FVOCI are classified at FVTPL. Unless hedge accounting is applied, gains or losses from financial assets at FVTPL are recognized as profit or loss and are included in 'Net gain(loss) on financial assets at fair value through profit or loss' in the consolidated statement of comprehensive income.

iv) Embedded derivatives

Financial assets with embedded derivatives are classified regarding the entire hybrid contract, and the embedded derivatives are not separately recognized. The entire hybrid contract is considered when it is determined whether the contractual cash flows represent solely payments of principal and interest.

v) Derecognition of financial assets

The Group derecognizes a financial asset when the contractual rights to the cash flows from the asset expire, or it transfers the rights to receive the contractual cash flows on the financial asset in a transaction in which substantially all the risks and rewards of ownership of the financial asset are transferred. If the Group does not have or transfer most of the risks and rewards of ownership of the financial asset, the entity shall remove the financial asset if it does not control the financial asset. If the Group continues to control the financial asset, it continues to recognize the transferred asset to the extent that it is continuously involved and recognizes the related liability together.

If the Group transfers the right to cash flows of a financial asset but holds most of the risks and rewards of ownership of the financial asset, the entity shall continue to recognize the asset. Also, the amount of disposal received is recognized as a liability.

vi) Offsetting

Financial assets and financial liabilities are offset and the net amount is presented in the consolidated statement of financial position only when the Group currently has a legally enforceable right to set off the recognized amounts, and intends either to settle on a net basis or to realize the asset and settle the liability simultaneously.

SHINHAN FINANCIAL GROUP CO., LTD. AND SUBSIDIARIES

Notes to the Consolidated Financial Statements

December 31, 2021 and 2020

3. Significant accounting policies (continued)

(g) Derivative financial instruments

Derivatives are initially recognized at fair value. Subsequent to initial recognition, derivatives are measured at fair value, and changes therein are accounted for as described below.

i) Hedge accounting

The Group holds forward exchange contracts, interest rate swaps, currency swaps and other derivative contracts to manage interest rate risk and foreign exchange risk. The Group designated derivatives as hedging instruments to hedge the risk of changes in the fair value of assets, liabilities or firm commitments (a fair value hedge) and foreign currency risk of highly probable forecasted transactions or firm commitments (a cash flow hedge).

On initial designation of the hedge, the Group formally documents the relationship between the hedging instrument(s) and hedged item(s), including the risk management objectives and strategy in undertaking the hedge transaction. In addition, this document describes the hedging instrument, hedged item, and the method of evaluating the effect of the hedging instrument offsetting changes in the fair value or cash flow of the hedged item due to the hedged risk at the initiation of the hedging relationship and in subsequent periods.

① Fair value hedge

Changes in the fair value of a derivative hedging instrument designated as a fair value hedge are recognized in profit or loss. The gain or loss from remeasuring the hedging instrument at fair value for a derivative hedging instrument and the gain or loss on the hedged item attributable to the hedged risk are recognized in profit or loss in the same line item of the separate statement of comprehensive income.

The Group discontinues fair value hedge accounting if the hedging instrument expires or is sold, terminated or exercised, or if the hedge no longer meets the criteria. Any adjustment arising from G/L on the hedged item attributable to the hedged risk is amortized to profit or loss from the date the hedge accounting is discontinued.

② Cash flow hedge

When a derivative is designated to hedge the variability in cash flows attributable to a particular risk associated with a recognized asset or liability or a highly probable forecasted transaction that could affect profit or loss, the effective portion of changes in the fair value of the derivative is recognized in other comprehensive income, net of tax, and presented in the hedging reserve in equity. Any ineffective portion of changes in the fair value of the derivative is recognized immediately in profit or loss.

If the hedging instrument no longer meets the criteria for hedge accounting, expires or is sold, terminated, exercised, or the designation is revoked, then hedge accounting is discontinued prospectively. The cumulative gain or loss on the hedging instrument that has been recognized in other comprehensive income is reclassified to profit or loss in the periods during which the forecasted transaction occurs. If the forecasted transaction is no longer expected to occur, then the balance in other comprehensive income is recognized immediately in profit or loss.

③ Net investment hedge

The portion of the change in fair value of a financial instrument designated as a hedging instrument that meets the requirements for hedge accounting for a net investment in a foreign operation is recognized in other comprehensive income and the ineffective portion of the hedge is recognized in profit or loss. The portion recognized as other comprehensive income that is effective as a hedge is recognized in the statement of comprehensive income as a result of reclassification adjustments in accordance with K-IFRS No. 1021, "Effect of Changes in Foreign Exchange Rates" at the time of disposing of its overseas operations or disposing of a portion of its overseas operations to profit or loss.

SHINHAN FINANCIAL GROUP CO., LTD. AND SUBSIDIARIES

Notes to the Consolidated Financial Statements

December 31, 2021 and 2020

3. Significant accounting policies (continued)

(g) Derivative financial instruments (continued)

ii) Other derivative financial instruments

All derivatives except those designated as hedging instruments and are effective in hedging are measured at fair value. Changes in the fair value of other derivative financial instrument not designated as a hedging instrument are recognized immediately in profit or loss.

iii) Gains and losses on initial recognition

Any difference between the fair value of over the counter derivatives at initial recognition and the amount that would be determined at that date using a valuation technique in a situation in which the valuation is dependent on unobservable parameters is not recognized in profit or loss but is deferred, and the deferred gains and losses on initial transaction are depreciated on a straight-line basis over the life of the instrument or the remainder is recognized in profit or loss immediately when the fair value becomes observable.

(h) Expected credit losses of Financial assets

The Group recognizes allowance for credit loss for debt instruments measured at amortized cost and fair value through other comprehensive income, and lease receivable, loan commitments and financial guarantee contracts using the expected credit loss impairment model. Financial assets migrate through the following three stages based on the change in credit risk since initial recognition and allowance for credit loss for the financial assets are measured at the 12-month expected credit losses (“ECL”) or the lifetime ECL, depending on the stage.

	<u>Category</u>	<u>Allowance for credit loss</u>
STAGE 1	When credit risk has not increased significantly since the initial recognition	12-months ECL: the ECL associated with the probability of default events occurring within the next 12 months
STAGE 2	When credit risk has increased significantly since the initial recognition	Lifetime ECL: a lifetime ECL associated with the probability of default events occurring over the remaining lifetime
STAGE 3	When assets are impaired	Same as above

The Group, meanwhile, only recognizes the cumulative changes in lifetime expected credit losses since the initial recognition as an allowance for credit loss for purchased or originated credit-impaired financial assets.

The total period refers to the expected life span of the financial instrument up to the contract expiration date.

SHINHAN FINANCIAL GROUP CO., LTD. AND SUBSIDIARIES

Notes to the Consolidated Financial Statements

December 31, 2021 and 2020

3. Significant accounting policies (continued)

(h) Expected credit losses of Financial assets (continued)

i) Reflection of forward-looking information

The Group reflects forward-looking information presented by internal experts based on a variety of information when measuring expected credit losses. Assuming that the measurement factor of expected credit losses has a certain correlation with economic fluctuations, the expected credit losses are calculated by reflecting forward-looking information through modeling between macroeconomic variables and measurement factors.

ii) Measurement of expected credit loss of financial assets at amortization cost

The expected credit loss of an amortized financial asset is measured as the difference between the present value of the cash flows expected to be received and the cash flow expected to be received. For this purpose, we calculate expected cash flows for individually significant financial assets. For non-individual significant financial assets, the financial assets collectively include expected credit losses as part of a set of financial assets with similar credit risk characteristics.

Expected credit losses are deducted using the allowance for credit loss account and are written off if the financial assets are not recoverable. The allowance for credit loss is increased when the written-off loan receivables are subsequently collected and changes in the allowance for credit loss are recognized in profit or loss.

iii) Measurement of estimated credit loss of financial assets at FVOCI

The calculation of expected credit losses is the same as for financial assets measured at amortized cost, but changes in allowance for credit loss are recognized in other comprehensive income. In the case of disposal and redemption of other comprehensive income - fair value, the allowance for credit loss is reclassified from other comprehensive income to profit or loss and recognized in profit or loss.

(i) Property and equipment

Property and equipment are initially measured at cost and after initial recognition. The cost of property and equipment includes expenditures arising directly from the construction or acquisition of the asset, any costs directly attributable to bringing the asset to the location and condition necessary for it to be capable of operating in the manner intended by management and the initial estimate of the costs of dismantling and removing the item and restoring the site on which it is located. Certain land and buildings are measured at fair value at the date of transition to K-IFRS, which is deemed cost, in accordance with K-IFRS No.1101, 'First-time Adoption of K-IFRS'. Subsequent to initial recognition, the asset is measured at cost less accumulated depreciation and accumulated impairment losses, if any.

The Group recognizes in the carrying value of an item of property and equipment the cost of replacing part of property and equipment when that cost is incurred if it is probable that future economic benefits associated with the item will flow to the Group and the cost of the item can be measured reliably. The carrying value of those parts that are replaced is derecognized. The costs of the day-to-day servicing of property and equipment are recognized in profit or loss as incurred.

Land is not depreciated. Other property and equipment are depreciated on a straight-line basis over the estimated useful lives, which most closely reflect the expected pattern of consumption of the future economic benefits embodied in the asset. The estimated useful lives for the current and comparative periods are as follows:

Descriptions	Useful lives
Buildings	40~50 years
Other properties	4~5 years

SHINHAN FINANCIAL GROUP CO., LTD. AND SUBSIDIARIES

Notes to the Consolidated Financial Statements

December 31, 2021 and 2020

3. Significant accounting policies (continued)

(i) Property and equipment (continued)

Depreciation methods, useful lives and residual values are reassessed at each fiscal year-end and in case adjustments are needed, it is accounted for as a change in accounting estimate.

(j) Intangible assets

Intangible assets are measured initially at cost and, subsequently, are carried at cost less accumulated amortization and accumulated impairment losses.

Amortization of intangible assets except for goodwill is calculated on a straight-line basis over the estimated useful lives of intangible assets as shown below, from the date that they are available for use. The residual value of intangible assets is zero. However, if there are no foreseeable limits to the periods over which certain intangible assets are expected to be available for use, they are determined to have indefinite useful lives and are not amortized.

Descriptions	Useful lives
Software	5 years
Capitalized development cost	5 years
Other intangible assets	5 years or contract periods

Amortization periods and the amortization methods for intangible assets with finite useful lives are reviewed at the end of each reporting period. The useful lives of intangible assets that are not being amortized are reviewed at the end of each reporting period to determine whether events and circumstances continue to support indefinite useful life assessments for those assets. Changes are accounted for as changes in accounting estimates.

Expenditures on research activities, undertaken with the prospect of gaining new technical knowledge and understanding, are recognized in profit or loss as incurred. Development expenditures are capitalized only if development costs can be measured reliably, the product or process is technically and commercially feasible, future economic benefits are probable, and the Group intends to and has sufficient resources to complete development and to use or sell the asset. Other development expenditures are recognized in profit or loss as incurred.

(k) Investment properties

Investment property is property held either to earn rental income or for capital appreciation or both. An investment property is initially recognized at cost including any directly attributable expenditure. Subsequent to initial recognition, the asset is measured at cost less accumulated depreciation and accumulated impairment losses, if any.

The depreciation method and the estimated useful lives for the current and comparative periods are as follows:

Descriptions	Useful lives	Depreciation method
Buildings	40 years	Straight-line

SHINHAN FINANCIAL GROUP CO., LTD. AND SUBSIDIARIES

Notes to the Consolidated Financial Statements

December 31, 2021 and 2020

3. Significant accounting policies (continued)

(I) Leases

i) Accounting treatment as the lessee

The Group leases various tangible assets, such as real estate and vehicles, and each of the lease contract is negotiated individually and includes a variety of terms and conditions. There are no other restrictions imposed by the lease contracts, but the lease assets cannot be provided as collaterals for borrowings.

At the commencement date of the lease, the Group recognizes the right-of-use assets and the lease liabilities. Each lease payment is allocated to payment for the principal portion of the lease liability and financial costs. The Group recognizes in profit or loss the amount calculated to produce a constant periodic rate of interest on the lease liability balance for each period as financial costs. Right-of-use assets are depreciated using a straight-line method from the commencement date over the lease term.

Lease liabilities are measured at the present value of the lease payments that are not paid at the commencement date of the lease, and the lease payments included in the measurement of the liabilities consist of the following payments:

- Fixed payments (including in-substance fixed payments, less any lease incentives receivable)
- Variable lease payments depending on the index or rate(interest rate)
- Amounts expected to be paid by the lessee under the residual value guarantee
- The exercise price of a purchase option if the lessee is reasonably certain to exercise that option
- Payments of penalties for terminating the lease, if the lease term reflects the lessee exercising an option to terminate the lease

If the interest rate implicit in the lease is readily determined, the lease payments are discounted by the rate; if the rate is not readily determined, the lessee's incremental borrowing rate is used.

The cost of the right-of-use assets comprise:

- The amount of the initial measurement of the lease liability
- Any lease payments made at or before the commencement date (less any lease incentives received)
- Any initial direct costs incurred by the lessee
- An estimate of costs to be incurred by the lessee in dismantling and removing the underlying asset, restoring the site on which it is located or restoring the underlying asset to the condition required by the terms and conditions of the lease

Lease payments related to short-term leases or low-value assets are recognized as current expenses over the lease term using the straight-line method. A short-term lease is a lease that has a lease term of 12 months or less, and the low-value assets lease is a lease of which the underlying asset value is not more than ₩6 million.

Additional considerations for the Group when accounting for lessees include:

Extension and termination options are included in a number of real estate lease contracts of the Group. In determining the lease term, management considers all relevant facts and circumstances that create an economic incentive not to exercise the options. The periods covered by, a) an option to extend the lease if the lessee is reasonably certain to exercise that option, or b) an option to terminate the lease if the lessee is reasonably certain not to exercise that option, is included when determining the lease term. The Group reassesses whether the Group is reasonably certain to exercise the extension option, or not to exercise a termination option, upon the occurrence of either a significant event or a significant change in circumstances that is within the control of the lessee, and affects whether the lessee is reasonably certain to exercise an option not previously included in its determination of the lease term, or not to exercise an option previously included in its determination of the lease term.

SHINHAN FINANCIAL GROUP CO., LTD. AND SUBSIDIARIES

Notes to the Consolidated Financial Statements

December 31, 2021 and 2020

3. Significant accounting policies (continued)

(l) Leases (continued)

ii) Accounting treatment as the lessor

The Group leases out to lessee various tangible assets, including vehicles under operating and finance lease contracts, and each of the lease contract is negotiated individually and includes a variety of terms and conditions. The risk management method for all rights held by the Group in the underlying assets includes repurchase agreements, residual value guarantees, etc.

① Finance leases

The Group recognizes them as a receivable at an amount equal to the net investment in the lease, and the difference from the carrying value of the leasing asset as of the commencement date is recognized as profit or loss from disposal of the lease asset. In addition, interest income is recognized by applying the effective interest method for the amount of the Group's net investment in finance leases. Lease-related direct costs are included in the initial recognition of financial lease receivables and are accounted for in a way that reduces the revenue for the lease term.

② Operating leases

The Group recognizes the lease payments as income on straight-line basis, and adds the lease initial direct costs incurred during negotiation and contract phase of the operating lease to the carrying value of the underlying asset. In addition, the depreciation policy of operating lease assets is consistent with the Group's depreciation policy of other similar assets.

(m) Assets held for sale

Non-current assets, or disposal groups comprising assets and liabilities, that are expected to be recovered primarily through sale rather than through continuing use, are classified as held for sale. In order to be classified as held for sale, the asset (or disposal group) must be available for immediate sale in its present condition and its sale must be highly probable. The assets or disposal group that are classified as non-current assets held for sale are measured at the lower of their carrying value and fair value less cost to sell.

The Group recognizes an impairment loss for any initial or subsequent write-down of an asset (or disposal group) to fair value less costs to sell, and a gain for any subsequent increase in fair value less costs to sell, up to the cumulative impairment loss previously recognized.

An asset that is classified as held for sale or part of a disposal group classified as held for sale is not depreciated (or amortized).

SHINHAN FINANCIAL GROUP CO., LTD. AND SUBSIDIARIES

Notes to the Consolidated Financial Statements

December 31, 2021 and 2020

3. Significant accounting policies (continued)

(n) Impairment of non-financial assets

The carrying values of the Group's non-financial assets, other than assets arising from employee benefits, deferred tax assets and non-current assets held for sale, are reviewed at the end of the reporting period to determine whether there is any indication of impairment. If any such indication exists, then the asset's recoverable amount is estimated.

Goodwill and intangible assets that have indefinite useful lives or that are not yet available for use, irrespective of whether there is any indication of impairment, are tested for impairment annually by comparing their recoverable amount to their carrying value.

The Group estimates the recoverable amount of an individual asset, and if it is impossible to measure the individual recoverable amount of an asset, then the Group estimates the recoverable amount of cash-generating unit ("CGU"). The recoverable amount of an asset or a CGU is the greater of its value in use and its fair value less costs to sell. The value in use is estimated by applying a pre-tax discount rate that reflects current market assessments of the time value of money and the risks specific to the asset or the CGU for which estimated future cash flows have not been adjusted, to the estimated future cash flows expected to be generated by the asset or the CGU.

An impairment loss is recognized if the carrying value of an asset or a CGU exceeds its recoverable amount. Impairment losses are recognized in profit or loss.

Goodwill acquired in a business combination is allocated to each CGU that is expected to benefit from the synergies arising from the goodwill acquired. Any impairment identified at the CGU level will first reduce the carrying value of goodwill and then be used to reduce the carrying value of the other assets in the CGU on a pro rata basis. Impairment losses of goodwill cannot be reversed in the subsequent period. At the end of each reporting period, the Group reviews whether there are any signs of impairment loss that has been recognized in the prior period no longer exists or has decreased, and reversal occurs only if there is a change in the estimate used to determine the recoverable amount after the recognition of the impairment loss. The asset's carrying value does not exceed the carrying value that would have been determined, net of depreciation or amortization, if no impairment loss had been recognized.

(o) Non-derivative financial liabilities

The Group recognizes financial liabilities in the consolidated statement of financial position when the Group becomes a party to the contractual provisions of the financial liability in accordance with the substance of the contractual arrangement and the definitions of financial liabilities.

Transaction costs on the financial liabilities at FVTPL are recognized in profit or loss as incurred.

i) Financial liabilities designated at FVTPL

Financial liabilities can be irrevocably designated as measured at FVTPL if doing so eliminates or significantly reduces an accounting mismatch that would otherwise arise from measuring assets or liabilities or recognizing the gains and losses on them on different bases, or a group of financial instruments is managed and its performance is evaluated on a fair value basis, in accordance with a documented risk management or investment strategy. The amount of change in the fair value of the financial liabilities designated at FVTPL that is attributable to changes in the credit risk of that liabilities shall be presented in other comprehensive income.

ii) Financial liabilities at FVTPL

Since initial recognition, financial liabilities at FVTPL is measured at fair value, and changes in the fair value are recognized as profit or loss.

SHINHAN FINANCIAL GROUP CO., LTD. AND SUBSIDIARIES

Notes to the Consolidated Financial Statements

December 31, 2021 and 2020

3. Significant accounting policies (continued)

(o) Non-derivative financial liabilities (continued)

iii) Other financial liabilities

Non-derivative financial liabilities other than financial liabilities at fair value through profit or loss are classified as other financial liabilities, and other financial liabilities include deposits, borrowings, debt securities and etc. At the date of initial recognition, other financial liabilities are measured at fair value minus transaction costs that are directly attributable to the acquisition. Subsequent to initial recognition, other financial liabilities are measured at amortized cost using the effective interest method.

The Group derecognizes a financial liability from the consolidated statement of financial position when it is extinguished (i.e. when the obligation specified in the contract is discharged, cancelled or expires).

(p) Foreign currency

i) Foreign currency transactions

Transactions in foreign currencies are translated to the respective functional currencies of the Group at exchange rates at the dates of the transactions. Monetary assets and liabilities denominated in foreign currencies at the end of the reporting period are retranslated to the functional currency using the exchange rate at the end of the reporting period. Non-monetary foreign currency items measured at fair value are converted to the exchange rate on the date the fair value is determined, and non-monetary items measured at historical cost are converted to the exchange rate on the trading day.

All foreign currency differences arising from the conversion of monetary items are recognised in profit or loss. However, the Group excludes currency differences at the time of settlement of monetary items, conversion differences in net investments in foreign operations and conversion differences for financial liabilities designated cash flow hedges. If gains or losses arising from non-monetary items are recognised in other comprehensive income, the effect of exchange rate changes included in those gains or losses is also recognised in other comprehensive income. In addition, if recognised in profit or loss, the effect of exchange rate changes is also recognised in profit or loss.

ii) Foreign operations

If the presentation currency of the Group is different from a foreign operation's functional currency, the financial statements of the foreign operation are translated into the presentation currency using the following methods:

The assets and liabilities of foreign operations, whose functional currency is not the currency of a hyperinflationary economy, are translated to presentation currency at exchange rates at the reporting date. The income and expenses of foreign operations are translated to functional currency at exchange rates at the dates of the transactions. Foreign currency differences are recognized in other comprehensive income.

Any goodwill arising on the acquisition of a foreign operation and any fair value adjustments to the carrying values of assets and liabilities arising on the acquisition of that foreign operation are treated as assets and liabilities of the foreign operation and are translated using the exchange rate at the reporting date.

Upon disposal of foreign operations, the cumulative amount of the exchange differences recognized as a separate line item within the equity and other comprehensive income is reclassified from other comprehensive income to profit and loss at the time of recognition. When disposing subsidiaries, including foreign operations, proportional shares of exchange differences recognized in other comprehensive income are reverted to non-controlling shares of foreign operations, and in other cases, disposing some of the portions of foreign operations, only the proportional shares of the accumulated exchange differences recognized in other comprehensive income are classified as profit and loss.

SHINHAN FINANCIAL GROUP CO., LTD. AND SUBSIDIARIES

Notes to the Consolidated Financial Statements

December 31, 2021 and 2020

3. Significant accounting policies (continued)

(p) Foreign currencies (continued)

iii) Net investment in a foreign operation

If the settlement of a monetary item receivable from or payable to a foreign operation is neither planned nor likely in the foreseeable future, then foreign currency differences arising on the item form part of the net investment in the foreign operation and are recognized in other comprehensive income and reclassified from equity to profit or loss on disposal of the net investment.

(q) Equity capital

i) Capital stock

Capital stock is classified as equity. Incremental costs directly attributable to the transaction of stock are deducted from equity, net of any tax effects.

Preferred stocks are classified as equity if they do not need to be repaid or are repaid only at the option of the Group and if payment is determined by the Group's discretion, and dividends are recognized when the shareholders' meeting approves the dividends. Preferred stocks that are eligible for reimbursement of a defined or determinable amount on or after a certain date are classified as liabilities. The related dividend is recognized in profit or loss at the time of occurrence as interest expense.

ii) Hybrid bonds

The Group classifies an issued financial instrument, or its component parts, as a financial liability or an equity instrument depending on the substance of the contractual arrangement of such financial instrument. Hybrid bonds where the Group has an unconditional right to avoid delivering cash or another financial asset to settle a contractual obligation are classified as an equity instrument and presented in equity. Hybrid bonds issued by subsidiaries of the group are classified as non-controlling interests according to this classification criteria. In addition, distributions paid are treated as net income attributable to non-controlling interests in the consolidated statement of comprehensive income.

iii) Capital adjustment

The effect of changes in ownership interests in subsidiaries that do not lose control over the equity attributable to owners of the parent is included in capital adjustments.

SHINHAN FINANCIAL GROUP CO., LTD. AND SUBSIDIARIES

Notes to the Consolidated Financial Statements

December 31, 2021 and 2020

3. Significant accounting policies (continued)

(r) Employee benefits

i) Short-term employee benefits

Short-term employee benefits are employee benefits that are due to be settled within 12 months after the end of the period in which the employees render the related service. When an employee has rendered service to the Group during an accounting period, the Group recognizes the undiscounted amount of short-term employee benefits expected to be paid in exchange for that service.

ii) Other long-term employee benefits

The Group's net obligation in respect of other long-term employee benefits that are not expected to be settled wholly before 12 months after the end of the annual reporting period in which the employees render the related service, is the amount of future benefit that employees have earned in return for their service in the current and prior periods. That benefit is discounted to determine its present value. Remeasurements are recognized in profit or loss in the period in which they arise.

iii) Retirement benefits: defined contribution plans

The Group recognizes the contribution expense as an account of severance payments in profit or loss in the period according to the defined contribution plans, when an employee provides work services for a certain period of time, except for the case when it is included in the cost of the asset. Contributions payable are recognized as liabilities (unpaid expenses) after deducting the contributions already paid. In addition, if the contribution already paid exceeds the contribution due for services provided before the end of the reporting period, the future contribution is reduced or cash refunded due to the excess is recognized as an asset (prepaid expense).

iv) Retirement benefits: defined benefit plans

For the year ended December 31, 2021, defined benefit liabilities related to the defined benefit plan are recognized by deducting the fair value of external reserve from the present value of the defined benefit plan debt.

Defined benefit liabilities are calculated annually by independent actuaries using the predicted unit credit method. If the net present value of the defined benefit obligation less the fair value of the plan assets is an asset then the present value of the economic benefits available to the entity in the form of a refund from the plan or a reduction in future contributions to the plan.

The remeasurement component of net defined benefit liability is the change in the effect on asset ceiling except for the amount included in the net interest income of plan assets and net revenues of plan assets excluding actuarial gains and losses to the net of defined benefit liabilities. It is immediately recognized in other comprehensive income. The Group determines the net interest on the net defined benefit obligation (asset) by multiplying the net defined benefit obligation (asset) by the discount rate determined at the beginning of the annual reporting period and is the net present value of the net defined benefit obligation. It is determined by taking into consideration the fluctuations. Net interest expense and other expenses related to defined benefit plans are recognized in profit or loss.

When an amendment or reduction of the system occurs, the gain or loss resulting from the change or decrease in the benefits to the past service is immediately recognized in profit or loss. The Group recognizes gains or losses on settlement when the defined benefit plan is settled.

SHINHAN FINANCIAL GROUP CO., LTD. AND SUBSIDIARIES

Notes to the Consolidated Financial Statements

December 31, 2021 and 2020

3. Significant accounting policies (continued)

(r) Employee benefit (continued)

v) *Termination benefits*

Termination benefits are recognized as an expense when the Group is committed demonstrably, without realistic possibility of withdrawal, to a formal detailed plan to either terminate employment before the normal retirement date, or to provide termination benefits as a result of an offer made to encourage voluntary redundancy. Termination benefits for voluntary redundancies are recognized as an expense if the Group has made an offer of voluntary redundancy, it is probable that the offer will be accepted, and the number of acceptances can be estimated reliably. If benefits are payable more than 12 months after the reporting period, then they are discounted to their present value.

(s) Share-based payment transactions

In regards to the share-based payment transactions which grants an employee a stock or stock option in exchange for the goods or services provided, if the fair value of the goods or services provided or the fair value of the goods or services provided cannot be reliably measured, the Group indirectly measures the fair value of the goods or services based on the fair value of the given equity, and the amount is recognized as employee benefit expenses and capital during the vesting period. For share-based payment awards with non-vesting conditions, the grant date fair value of the share-based payment is measured to reflect such conditions and there is no true-up for differences between expected and actual outcomes.

The fair value of the amount payable to employees in respect of share appreciation rights, which are settled in cash, is recognized as an expense with a corresponding increase in liabilities, over the period that the employees unconditionally become entitled to payment. The liability is remeasured at each reporting date and at settlement date. Any changes in the fair value of the liability are recognized as personnel expense in profit or loss.

(t) Provisions

Provisions are recognized when the Group has a present legal or constructive obligation as a result of a past event, it is probable that an outflow of resources embodying economic benefits will be required to settle the obligation and a reliable estimate can be made of the amount of the obligation.

The risks and uncertainties that inevitably surround many events and circumstances are taken into account in reaching the best estimate of a provision. Where the effect of the time value of money is material, provisions are determined at the present value of the expected future cash flows.

Provisions are reviewed at the end of each reporting period and adjusted to reflect the current best estimate. If it is no longer probable that an outflow of resources embodying economic benefits will be required to settle the obligation, the provision is reversed.

Provisions shall be used only for expenditures for which the provisions are originally recognized.

SHINHAN FINANCIAL GROUP CO., LTD. AND SUBSIDIARIES

Notes to the Consolidated Financial Statements

December 31, 2021 and 2020

3. Significant accounting policies (continued)

(u) Financial guarantee contract

A financial guarantee contract is a contract that requires the Group to make specified payments to reimburse the holder for a loss it incurs because a specified debtor fails to make payment when due in accordance with the original or modified terms of a debt instrument.

Financial guarantee contracts are recognized initially at their fair value, and the initial fair value is amortized over the life of the financial guarantee contract.

After initial recognition, financial guarantee contracts are measured at the higher of:

- Loss allowance in accordance with K-IFRS No.1109, 'Financial Instruments'
- The amount initially recognized less, when appropriate, the cumulative amount of income recognized in accordance with the principles of K-IFRS No.1115, 'Revenue from Contracts with Customers'

(v) Insurance contracts

i) Investment contract liabilities, including insurance contract liabilities and discretionary dividend factors

The group establishes liability reserves in accordance with the Insurance Business Law and the related regulations. The reserves are calculated according to the insurance policy, insurance premiums and liability reserve calculation method. The main contents are as follows.

i-1) Premium reserves

This is the amount to be accumulated for insurance claim payable for the existing contracts as of the end of the reporting period, the reserves are calculated by deducting the present value of net premiums to be earned after the end of the reporting period from the present value of claims to be paid to the policyholder after the date of the statement of financial position.

i-2) Prepaid premium reserves

Among premiums that are due for payment before the end of the reporting period, the prepaid premium reserves for the next period are calculated through a premium and liability reserves calculation method.

i-3) Guarantee reserves

The total amount of reserve for variable minimum guarantee (①) and reserve for general account guarantee (②) is provided as guarantee reserve.

① Variable minimum guarantee reserve

This reserve is the amount that must be accumulated to guarantee insurance premiums above a certain level for contracts maintained as of the end of the reporting period, and is measured at the higher of:

- i) the average amount of the top 30% of net loss expected in the future
- ii) the minimum required amount by insurance types, minimum guarantees, level of guarantees and limits of stock investment portion

SHINHAN FINANCIAL GROUP CO., LTD. AND SUBSIDIARIES

Notes to the Consolidated Financial Statements

December 31, 2021 and 2020

3. Significant accounting policies (continued)

(v) Insurance contracts (continued)

② General account guarantee reserve

As of the end of the reporting period, the amount of reserve for insurance contracts that are insured under general account is required to be paid to guarantee the level of refunds, and select the largest of the following:

- i) Average of the amount deducted from the appropriateness of the liability reserve calculated by excluding the guarantee option from the appropriateness evaluation of the liability reserve calculated by including the guarantee option for each interest rate scenario
- ii) The amount of compensation (including annulment contract) against the guarantee received from the policy holder by the rate applied at the premium calculation in the insurance premium and liability reserve calculation method

i-4) Reserve for outstanding claims

As of the end of the reporting period, the Group has accrued the amount for which the reason for the payment of insurance claims, etc. has been incurred and the amount of the claim payment has not been paid yet due to the dispute or lawsuit related to the insurance settlement (pending in the Financial Dispute Mediation Committee). In addition, the Group recognizes unrecognized losses based on historical experience.

i-5) Reserves for participating policyholders' dividends

The reserve is provided for the purpose of contributing to the policyholder dividend according to the laws and regulations and the reserve for dividend reserve for the policyholder and the dividend reserve for the subsequent business year.

The policyholder dividend reserve is the amount that is not paid as of the end of the reporting period for the settlement amount and the reserve for dividend policy for the next fiscal year is based on the policyholder dividend calculated on the insurance contract effective as of the end of the reporting period.

① Excess crediting rate reserve

In the case of a dividend insurance contract which has been maintained for more than one year as of the end of the reporting period among contracts signed before October 1, 1997, the difference between the planned interest rate and the one-year maturity deposit rate shall be preserved.

② Mortality dividend reserve

Dividends arising from contracts that are maintained for more than one year at the end of the reporting period are used to offset the expected mortality and actual mortality rates applied to premiums.

③ Interest dividend reserve

For the contracts that have been maintained for more than one year as of the end of the reporting period, the amount calculated by applying the interest dividend reserve rate to the net written premium reserve less the unearned acquisition costs. However, the insurance sold before October 1, 1997 is applied to the amount deducted from the net premium in the event that the planned interest rate by the insurance product is less than the dividend standard.

④ Reserves for long-term special dividends

For the effective dividend policy agreement that has been maintained for 6 years or more, the amount calculated by applying the long-term special dividend rate to the amount deducted from the net premiums for the end of the year.

SHINHAN FINANCIAL GROUP CO., LTD. AND SUBSIDIARIES

Notes to the Consolidated Financial Statements

December 31, 2021 and 2020

3. Significant accounting policies (continued)

(v) Insurance contracts (continued)

However, insurance sold before October 1, 1997 is applied to the deduction of unearned premiums at the end of the year when the expected interest rate by the insurance product is less than the dividend standard rate.

i-6) Reserve for interest dividends

In order to cover the policyholder dividend in the future, the total amount is set aside according to business performance according to the law or insurance contracts.

i-7) Reserve for dividend insurance loss reserve

In accordance with the regulations set by the supervisory authority, dividend insurance profit is accumulated within 30/100 of the contractor's stake. The reserve for the compensation of dividend insurance losses shall compensate for the loss of dividend insurance contracts in accordance with the provisions of the fiscal year within five years from the end of the accumulated reporting period and shall be used as the policyholder dividend source for the individual contractor.

ii) Contractor's equity adjustment

In accordance with K-IFRS No.1039, the Group classifies the gains and losses of available for sale financial assets as policyholder's equity and shareholders' equity based on the reserve ratio for dividend paying and non-dividend paying insurance for the year ended December 31, 2021, and the portion of policyholder's equity is accounted as policyholder's equity adjustment.

iii) Evaluation of debt appropriateness

At the end of each reporting period, the group assesses whether the recognized insurance liability is appropriate using the current estimates of future cash flows of the policy, and if the carrying value of the insurance liability is deemed to be inappropriate in terms of the estimated future cash flows. The reserve for premiums is added to the profit or loss by the amount corresponding to the deficiency.

iv) Reinsurance assets

The group presents the recoverable amount of reinsurance assets. The group assesses at the end of each reporting period whether there is objective evidence that a reinsurance asset is impaired. If there is objective evidence that the entity will not be able to collect all amounts under the terms of the agreement as a result of an event that occurred after the initial recognition and if the event has a reliable and measurable impact on the amount to be received. If reinsurance assets are determined to be impaired, impairment loss is recognized in the profit and loss for the current period.

v) Deferred acquisition cost

The group recognizes unrealized gains and losses arising from long-term insurance contracts as assets and amortizes the premiums over the life of the insurance contracts equally. If the contribution period exceeds 7 years, the amortization period is 7 years if there is an unrecognized balance at the date of the cancellation, the entire amount of the cancellation is amortized in the fiscal year to which the cancellation date belongs. But, if the ratio of additional premiums is higher at the early stage of the insurance period for the purpose of recovering the excess of the unearned premiums and the early settlement costs, the new settlement expenses are treated as the period expense.

SHINHAN FINANCIAL GROUP CO., LTD. AND SUBSIDIARIES

Notes to the Consolidated Financial Statements

December 31, 2021 and 2020

3. Significant accounting policies (continued)

(w) Recognition of revenues and expenses

The Group's revenues are recognized using five-step revenue recognition model as follows: ① 'Identifying the contract' → ② 'Identifying performance obligations' → ③ 'Determining the transaction price' → ④ 'Allocating the transaction price to performance obligations' → ⑤ 'Recognizing the revenue by satisfying performance obligations'.

i) Interest income and expense

Interest income and expense are recognized in profit or loss using the effective interest method. The effective interest rate is the rate that exactly discounts the estimated future cash payments and receipts through the expected life of the financial asset or liability or, where appropriate, a shorter period to the net carrying value of the financial asset or liability.

When calculating the effective interest rate, the Group estimates cash flows considering all contractual terms of the financial instrument, but does not consider future credit losses. The calculation includes all fees and points paid or received between parties to the contract that are an integral part of the effective interest rate, and all other premiums or discounts. When it is not possible to estimate reliably the cash flows or the expected life of a financial instrument, the Group uses the contractual cash flows over the full contractual term of the financial instrument.

Once a financial asset or a group of similar financial assets has been written down as a result of an impairment loss, interest income is thereafter recognized using the rate of interest used to discount the future cash flows for the purpose of measuring the impairment loss.

ii) Fees and commission

The recognition of revenue for financial service fees depends on the purposes for which the fees are assessed and the basis of accounting for any associated financial instrument.

① Fees that are an integral part of the effective interest rate of a financial instrument

Such fees are generally treated as an adjustment to the effective interest rate. Such fees may include compensation for activities such as evaluating the borrower's financial condition, evaluating and recording guarantees, collateral and other security arrangements, preparing and processing documents, closing the transaction and the origination fees received on issuing financial liabilities. However, when the financial instrument is measured at fair value with the change in fair value recognized in profit or loss, the fees are recognized as revenue when the instrument is initially recognized.

② Fees earned as services are provided

Fees and commission income, including investment management fees, sales commission, and account servicing fees, are recognized as the related services are provided.

SHINHAN FINANCIAL GROUP CO., LTD. AND SUBSIDIARIES

Notes to the Consolidated Financial Statements

December 31, 2021 and 2020

3. Significant accounting policies (continued)

(w) Recognition of revenues and expenses (continued)

③ Fees that are earned on the execution of a significant act

The fees that are earned on the execution of a significant act including commission on the allotment of shares or other securities to a client, placement fee for arranging a loan between a borrower and an investor and sales commission, are recognized as revenue when the significant act has been completed.

iii) Insurance income

The Group recognizes insurance income for the insurance premium paid of which the payment date arrived by the premium payment methods of the insurance contract; and recognizes advance receipts for the insurance premium paid of which the payment date has not arrived at the end of the reporting period.

iv) Dividend income

Dividend income is recognized when the shareholder's right to receive payment is established. Usually this is the ex-dividend date for equity securities. The Group provides compensation in various forms such as payment discounts and gifts.

(x) Revenue from Contracts with Customers

The fair value of the consideration received or receivable in exchange for the initial transaction is allocated to the reward points ("points") and the remainder of the fee income. The Group provides compensation in various forms such as payment discounts and free gifts. The consideration to be allocated to the points is estimated based on the fair value of the monetary benefits to be provided in consideration of the expected recovery rate of points awarded in accordance with the customer loyalty program and the expected time of recovery. Points for distribution through the cost paid by the customer is recognized by deducting from the revenue from fees.

SHINHAN FINANCIAL GROUP CO., LTD. AND SUBSIDIARIES

Notes to the Consolidated Financial Statements

December 31, 2021 and 2020

3. Significant accounting policies (continued)

(y) Income tax

Income tax expense comprises current and deferred tax. Current tax and deferred tax are recognized in profit or loss except to the extent that it relates to a business combination, or items recognized directly in equity or in other comprehensive income.

Current tax is the expected tax payable or receivable on the taxable profit or loss for the year, using tax rates enacted or substantively enacted at the end of the reporting period and any adjustment to tax payable in respect of previous years. The taxable profit is different from the accounting profit for the period since the taxable profit is calculated excluding the temporary differences, which will be taxable or deductible in determining taxable profit (tax loss) of future periods, and non-taxable or non-deductible items from the accounting profit. The unpaid taxes related to the Group's current tax are calculated using the enacted or substantially established tax rate.

Deferred tax is recognized, using the asset-liability method, in respect of temporary differences between the carrying values of assets and liabilities for financial reporting purposes and the amounts used for taxation purposes. A deferred tax liability is recognized for all taxable temporary differences. A deferred tax asset is recognized for all deductible temporary differences to the extent that it is probable that taxable profit will be available against which they can be utilized. However, deferred tax is not recognized for the following temporary differences: taxable temporary differences arising on the initial recognition of goodwill, or the initial recognition of assets or liabilities in a transaction that is not a business combination and that affects neither accounting profit or loss nor taxable income.

The Group applies a consolidated tax method based on a consolidated tax base and a domestic corporation (hereinafter referred to as the "Consolidated Entity Corporation ") that is fully controlled by the consolidated parent company and the consolidated tax base.

The Group evaluates the feasibility of temporary differences, taking into account the future taxable income of individual companies and consolidated groups, respectively. The change in deferred tax assets (liabilities) was recognized as expense (income), except for the amount associated with items directly added to the equity account.

For additional temporary differences in subsidiaries, associates, and joint venture investment interests, the Group may control the timing of the disappearance of temporary differences. All deferred tax liabilities are recognised except in cases where temporary differences are unlikely to dissipate in the foreseeable future. Deferred tax assets arising from deductible temporary differences are likely to be extinguished in the foreseeable future. In addition, It is recognised when taxable income is likely to be used for temporary differences.

The carrying value of deferred tax assets is reviewed at the end of each reporting period. The carrying value of deferred tax assets is reduced when it is no longer likely that sufficient taxable income will be generated to use benefits from deferred tax assets.

Deferred tax assets and liabilities are measured at the tax rates that are expected to apply to the period when the asset is realized or the liability is settled, based on tax rates (and tax laws) that have been enacted or substantively enacted by the end of the reporting period. The measurement of deferred tax liabilities and deferred tax assets reflects the tax consequences that would follow from the manner in which the Group expects, at the end of the reporting period to recover or settle the carrying value of its assets and liabilities.

Deferred tax assets and liabilities are corporate taxes imposed by the same taxation authority. Deferred tax assets and liabilities are offset only if there is a legally enforceable right to offset the related current tax liabilities and assets.

SHINHAN FINANCIAL GROUP CO., LTD. AND SUBSIDIARIES

Notes to the Consolidated Financial Statements

December 31, 2021 and 2020

3. Significant accounting policies (continued)

(y) Income tax (continued)

Because of the tax polices taken by the Group, tax uncertainties arise from the complexity of transactions and differences in tax law analysis. Also, it arises from a tax refund suit, tax investigation, or a refund suit against the tax authorities' tax amount. The Group paid the tax amount by the tax authorities in accordance with K-IFRS No. 2123. However, it will be recognized as the corporate tax assets if there is a high possibility of a refund in the future. In addition, the amount expected to be paid as a result of the tax investigation is recognized as the tax liability.

(z) Accounting for trust accounts

The Group accounts for trust accounts separately from its bank accounts under the Financial Investment Services and Capital Markets Act No. 114 and thus the trust accounts are not included in the accompanying consolidated financial statements. In this regard, the funds lent to the trust account are counted as trust account loans and loans borrowed from the trust account as other accounting accounts (non-payment of the trust account). In accordance with the Financial Investment Business Regulations, trust remuneration is acquired in connection with the operation, management, and disposal of trust property, and it is counted as the operating profit of trust business.

(aa) Earnings per share

The Group presents basic and diluted earnings per share (EPS) data for its ordinary shares. Basic EPS is calculated by dividing the profit or loss attributable to the ordinary shareholder of the Group by the weighted average number of common shares outstanding during the period, adjusted for own shares held. Diluted EPS is determined by adjusting the profit or loss attributable to ordinary shareholders and the weighted average number of ordinary shares outstanding, adjusted for own shares held, for the effects of all dilutive potential ordinary shares, which comprise share options granted to employees.

(ab) New standards and amendments not yet adopted by the Group

The following new accounting standards and amendments have been published that are not mandatory for annual periods beginning after January 1, 2021, and have not been early adopted by the Group.

i) K-IFRS No. 1103 'Business combination' amended – Reference to the Conceptual Framework

The amendments update a reference of definition of assets and liabilities to be recognized in a business combination in revised Conceptual Framework for Financial Reporting. However, the amendments add an exception for the recognition of liabilities and contingent liabilities within the scope of Korea IFRS 1037 Provisions, Contingent Liabilities and Contingent Assets, and Korean IFRS 2121 Levies. The amendments also clarify that contingent assets should not be recognized at the acquisition date. The amendments should be applied for annual periods beginning on or after January 1, 2022, and earlier application is permitted. The Group expects that the amendments will not have a significant impact on the consolidated financial statements.

(ii) K-IFRS No. 1016 'Property, Plant and Equipment' amended – Proceeds before the intended use

The amendments require the entity to recognize the proceeds from selling such items, and the costs of producing those items, in profit or loss, and prohibit an entity from deducting from the cost of an item of property, plant and equipment any proceeds from selling items produced while the entity is preparing the asset for its intended use. The amendments should be applied for annual periods beginning on or after January 1, 2022, and earlier application is permitted. The Group expects that the amendments will not have a significant impact on the consolidated financial statements.

SHINHAN FINANCIAL GROUP CO., LTD. AND SUBSIDIARIES

Notes to the Consolidated Financial Statements

December 31, 2021 and 2020

3. Significant accounting policies (continued)

(ab) New standards and amendments not yet adopted by the Group (continued)

(iii) *K-IFRS No. 1037, 'Provisions, Contingent Liabilities and Contingent Assets' amended - Onerous Contracts: Cost of Fulfilling a Contract*

The amendments clarify that the direct costs of fulfilling a contract include both the incremental costs of fulfilling the contract and an allocation of other costs directly related to fulfilling contracts when assessing whether the contract is onerous. The amendments should be applied for annual periods beginning on or after January 1, 2022, and earlier application is permitted. The Group expects that the amendments will not have a significant impact on the consolidated financial statements.

(iv) *K-IFRS No. 1001 'Presentation of Financial Statements' amended - Classification of Liabilities as Current or Non-current*

The amendments clarify that liabilities are classified as either current or non-current, depending on the substantive rights that exist at the end of the reporting period. Classification is unaffected by the likelihood that an entity will exercise right to defer settlement of the liability or the expectations of management. Also, the settlement of liability includes the transfer of the entity's own equity instruments, however, it would be excluded if an option to settle them by the entity's own equity instruments if compound financial instruments is met the definition of equity instruments and recognized separately from the liability. The amendments should be applied for annual periods beginning on or after January 1, 2023, and earlier application is permitted. The Group is reviewing the impact of amendments to the consolidated financial statements.

v) *K-IFRS No. 1117 'Insurance Contracts'*

K-IFRS No. 1117 *'Insurance Contracts'* enacted on April 23, 2021 will be applied for annual periods beginning on or after January 1, 2023. The standard will replace K-IFRS No. 1104 *'Insurance Contracts'* which is the current standard.

The main features of K-IFRS No. 1117 include measurement of the current value of insurance liabilities, recognition of insurance revenue on an accrual basis, and separate presentation of investment income from insurance performance. Under K-IFRS No. 1104, insurance liability was measured using historical information (e.g., interest rates at sale, etc.). In addition, when the entity receives the premium, it recognizes the premium received as an insurance revenue on a cash basis and there is no obligation to present insurance and investment income or expense separately. On the contrary, K-IFRS No. 1117 measures insurance liability at its present value by using updated discount rates which reflect current market-based information (i.e. at the reporting date) such as assumptions and risks. An insurance revenue is recognized on an accrual basis, reflecting the services provided to the policyholder by the insurance company for each accounting periods. Moreover, insurance finance income or expenses and the investment income or expenses will be presented separately.

If the Group applies K-IFRS No. 1117 in preparation of financial statements, significant differences with current financial statements may arise due to the following reasons. These differences do not include all of the future differences and they may be changed depending on further analysis.

① Evaluation of insurance liabilities

Under K-IFRS No. 1117, the Group estimates all cash flows under the insurance contract, then measure insurance liability by using discount rates that reflect assumptions and risks at the reporting date.

SHINHAN FINANCIAL GROUP CO., LTD. AND SUBSIDIARIES

Notes to the Consolidated Financial Statements

December 31, 2021 and 2020

3. Significant accounting policies (continued)

(ab) New standards and amendments not yet adopted by the Group (continued)

v) *K-IFRS No.1117 'Insurance Contracts' (continued)*

Specifically, the Group identifies a portfolio of insurance contracts which comprises contracts subject to similar risks and managed together and disaggregate the groups of insurance contracts with similar profitability within the portfolio. Then, the Group measures the groups of insurance contracts at the total of estimates of future cash flows (reflecting cash flows related to insurance contracts and the time value of money), risk adjustment and contractual service margin. Upon the application of K-IFRS No. 1117, contractual service margin account has been newly introduced. The contractual service margin presents the unrealized profit that the Group will recognize as it provides services in the future.

Reinsurance contract is an insurance contract issued by one entity (the reinsurer) to compensate another entity for claims arising from one or more insurance contracts issued by that another entity (underlying insurance contracts). When estimating present value of future cash flows arising from reinsurance contracts, the Group would use assumptions consistent with those it uses for the underlying contracts.

② Recognition and measurement of financial performance

According to K-IFRS No. 1117, insurance revenue is recognized on an accrual basis including services (insurance coverage) provided to the policyholder for each accounting period. Investment components (such as cancellation or maturity refunds) being repaid to the policyholder even if an insured event does not occur, are excluded from insurance revenue. Insurance finance income or expenses and investment income or expenses are presented separately to enable information users to understand the sources of profits or losses.

The Group includes time value of money and financial risk, and the effect of changes in the time value of money and financial risk related to the groups of insurance contracts in the insurance finance income or expenses. This requires the Group to make an accounting policy choice as to whether to disaggregate insurance finance income or expenses for the period between profit or loss and other comprehensive income.

③ Accounting policies related to conversion

According to K-IFRS No. 1117, the Group shall adjust the groups of insurance contracts issued before the transition date, that is measured at cost to be measured at its current value by applying a full retrospective approach, modified retrospective approach or fair value approach (January 1, 2022, the beginning of the annual reporting period immediately preceding the date of initial application).

In principle, the Group shall identify, recognize, and measure (full retrospective approach) each group of insurance contracts as if K-IFRS No. 1117 had been applied even before the transition date. However, if this approach is impracticable, the Group may choose to apply either the modified retrospective approach or fair value approach. On the other hand, for groups of insurance contracts with direct participation features which meet certain criteria, a fair value approach may be applied even if the full retrospective approach is applicable.

The objective of the modified approach is to achieve the closest outcome to retrospective application possible using reasonable and supportable information available without undue cost or effort. The fair value approach is an approach of assessing a group of insurance contracts using fair value assessments, etc. in accordance with K-IFRS No. 1113 '*Fair Value Measurement*'. To apply the fair value approach, the Group shall determine the contractual service margin or loss component of the liability for remaining coverage at the transition date as the difference between the fair value of a group of insurance contracts and the fulfilment cash flows measured at that date.

SHINHAN FINANCIAL GROUP CO., LTD. AND SUBSIDIARIES

Notes to the Consolidated Financial Statements

December 31, 2021 and 2020

3. Significant accounting policies (Continued)

(ab) New standards and amendments not yet adopted by the Group (continued)

v) *K-IFRS No.1117 'Insurance Contracts' (continued)*

④ Preparing for the application

As part of preparations for the launch of an integrated corporation in 2021, the Group has completed setting up actuarial assumptions and models and insurance liability settlement system. Within 2022, the Group is planning to foster and reinforce additional professionals and will continuously promote advancement, including improvements on system stability and verification of the consistency of data output. Also, the Group will overhaul and establish an internal accounting control system that goes along with the dynamic accounting environment in order to prepare and disclose reliable accounting information.

The application of K-IFRS No. 1117 will not only result to a change in accounting standards, but will also affect insurance product development, sales strategies, and long-term management strategies. Therefore, with the aim of re-establishment of the overall business management system, the Group will continue to provide training to the employees and report to the management the status and implementation plan of K-IFRS No. 1117.

⑤ Financial impact assessment

As the implementation of K-IFRS No. 1117 results to changes in the valuation of liabilities, revenue recognition, etc., the Group believes that the impact of this standard on the financial statements will be significant. The Group is determining the impacts on the consolidated financial statements due to the application of the standard. As of December 31, 2021, the Group has an insurance contract liability of ₩ 61,183,934 million, calculated in accordance with K-IFRS No.1004 'Insurance contracts'.

vi) *Annual Improvements to K-IFRSs 2018-2020 Cycle*

For Annual Improvements to K-IFRSs 2018-2020 Cycle, the amendments will take effect for annual periods beginning after January 1, 2022 and are permitted for early application. The Group expects that the amendments will not have a significant impact on the consolidated financial statements.

- K-IFRS No.1101, '*First-time Adoption of K-IFRS*'-First-time adopter subsidiaries
- K-IFRS No.1109, '*Financial Instruments*' -10% test-related fee for financial liabilities removal
- K-IFRS No.1116, '*Leases*' -Lease incentives
- K-IFRS No.1041, '*Agriculture*' - Fair value measurement

SHINHAN FINANCIAL GROUP CO., LTD. AND SUBSIDIARIES

Notes to the Consolidated Financial Statements

December 31, 2021 and 2020

4. Financial risk management

(a) Overview

(a) Overview

Shinhan Financial Group Co., Ltd. (collectively the “Group”) manages various risks that may be arisen by each business sector and the major risks to which the Group is exposed include credit risk, market risk, interest rate risk, and liquidity risk. These risks are recognized, measured, controlled and reported in accordance with risk management guidelines established at the controlling company level and at the subsidiary level.

i) Risk management principles

The risk management principles of the Group are as follows:

- All business activities take into account the balance of risks and profits within a predetermined risk trend.
- The controlling company shall present the Group Risk Management Model Standards and supervise their compliance, and have responsibility and authority for group-level monitoring.
- Operate a risk-related decision-making system that enhances management's involvement.
- Organize and operate risk management organizations independent of the business sector.
- Operate a performance management system that clearly considers risks when making business decisions.
- Aim for preemptive and practical risk management functions.
- Share a cautious view to prepare for possible deterioration of the situation.

ii) Risk management organization

The basic policies and strategies for risk management of the Group are established by the Risk Management Committee (collectively the "Group Risk Management Committee") within the controlling company's Board of Directors. The Group's Chief Risk Management Officer (CRO) assists the Group Risk Management Committee and consults the risk policies and strategies of the group and each subsidiary through the Group Risk Council, which includes the Chief Risk Management Officer of each subsidiary. The subsidiary implements the risk policies and strategies of the Group through each company's risk management committee, risk-related committee, and risk management organization, and consistently establishes and implements the detailed risk policies and strategies of the subsidiary. The risk management team of the controlling company assists the Group's chief risk management officer for risk management and supervision.

Shinhan Financial Group has a hierarchical limit system to manage the risks of the Group to an appropriate level. The Group Risk Management Committee sets the risk limits that can be assumed by the Group and its subsidiaries, while the Risk Management Committee and the Committee of each subsidiary set and manage detailed risk limits by risk, department, desk and product types.

SHINHAN FINANCIAL GROUP CO., LTD. AND SUBSIDIARIES

Notes to the Consolidated Financial Statements

December 31, 2021 and 2020

4. Financial risk management (continued)

(a) Overview (continued)

ii) Risk management organization (continued)

① Group Risk Management Committee

The Group established the risk management system for the Group and each of its subsidiaries, and comprehensively manages group risk-related matters such as establishing risk policies, limits, and approvals. The Committee consists of directors of the Group.

The resolution of the Committee is as follows:

- Establish risk management basic policy in line with management strategy
- Determine the level of risk that can be assumed by the Group and each subsidiary
- Approve appropriate investment limit or loss allowance limit
- Enact and amend the Group Risk Management Regulations and the Group Risk Council Regulations
- Matters concerning risk management organization structure and division of duties
- Matters concerning the operation of the risk management system;
- Matters concerning the establishment of various limits and approval of limits
- Make decisions on approval of the FSS's internal rating law for non-retail and retail credit rating systems
- Matters concerning risk disclosure policy
- Analysis of crisis situation, related capital management plan and financing plan
- Matters deemed necessary by the board of directors
- Materials required by external regulations such as the Financial Services Commission and other regulations and guidelines
- Matters deemed necessary by the Chairman

The resolution of the Group Risk Management Committee is reported to the Board of Directors.

② Group Risk Management Council

In order to maintain the Group's risk policy and strategy consistently, the Group decides what is necessary to discuss the risks of the Group and to carry out the policies set by the Group Risk Management Committee. The members are chaired by the group's risk management officer and consist of the risk management officers of major subsidiaries.

iii) Group Risk Management System

① Management of the risk capital

Risk capital refers to the capital required to compensate for the potential loss (risk) if it is actually realized. Risk capital management refers to the management of the risk assets considering its risk appetite, which is a datum point on the level of risk burden compared to available capital, so as to maintain the risk capital at an appropriate level. The Group and subsidiaries establish and operate a risk planning process to reflect the risk plan in advance when establishing financial and business plans for risk capital management, and establish a risk limit management system to control risk to an appropriate level.

SHINHAN FINANCIAL GROUP CO., LTD. AND SUBSIDIARIES

Notes to the Consolidated Financial Statements

December 31, 2021 and 2020

4. Financial risk management (continued)

(a) Overview (continued)

iii) Group Risk Management System (continued)

② Risk Monitoring

In order to proactively manage risks by periodically identifying risk factors that can affect the group's business environment, the Group has established a multi-dimensional risk monitoring system. Each subsidiary is required to report to the Group on key issues that affect risk management at the group level. The Group prepares weekly, monthly and occasional monitoring reports to report to Group management including the CRO.

In addition, the Risk Dash Board is operated to derive abnormal symptoms through three-dimensional monitoring of major portfolios, increased risks, and external environmental changes (news) of assets for each subsidiary. If necessary, the Group takes preemptive risk management to establish and implement countermeasures.

③ Risk Reviewing

When conducting new product-new business and major policy changes, risk factors are reviewed by using a pre-defined checklist to prevent indiscriminate promotion of business that is not easy to judge risk and to support rational decision making. The subsidiary's risk management department conducts a preliminary review and post-monitoring process on products, services, and projects to be pursued in the business division. In case of matters that are linked or jointly promoted with other subsidiaries, the risk reviews are carried out after prior-consultation with the risk management department of the Group.

④ Risk management

The Group maintains a group wide risk management system to detect the signals of any risk crisis preemptively and, in the event of a crisis actually happening, to respond on a timely, efficient and flexible basis so as to ensure the Group's survival as a going concern. Each subsidiary maintains crisis planning for three levels of contingencies, namely, 'alert', 'imminent crisis' and 'crisis' determination of which is made based on quantitative and qualitative monitoring and consequence analysis, and upon the happening of any such contingency, is required to respond according to a prescribed contingency plan. At the controlling company level, the Group maintains and installs crisis detection and response system which is applied consistently group-wide, and upon the happening of any contingency at two or more subsidiary level, the Group directly takes charge of the situation so that the Group manages it on a concerted group wide basis.

SHINHAN FINANCIAL GROUP CO., LTD. AND SUBSIDIARIES

Notes to the Consolidated Financial Statements

December 31, 2021 and 2020

4. Financial risk management (continued)

(b) Credit risk

Credit risk is the risk of potential economic loss that may be caused if a customer or counterparty to a financial instrument fails to meet its contractual obligations, and is the largest risk which the Group is facing. The Group's credit risk management encompasses all areas of credit that may result in potential economic loss, including not just transactions that are recorded on balance sheets, but also off-balance-sheet transactions such as guarantees, loan commitments and derivative transactions.

Shinhan Bank's basic policy on credit risk management is determined by the Risk Policy Committee. The Risk Policy Committee consists of the chairman of the CRO, the Chief Credit Officer (CCO), the head of the business group, and the head of the risk management department, and decides the credit risk management plan and the direction of the loan policy for the entire bank. Apart from the Risk Policy Committee, the Credit Review Committee is established to separate credit monitoring, such as large loans and limit approval, and is composed of chairman, the CCO, CRO and the head of the group in charge of the credit-related business group, the head of the credit planning department, and the senior examination team to enhance the credit quality of the loan and profitability of operation.

Shinhan Bank's credit risk management includes processes such as credit evaluation, credit monitoring, and credit supervision, and credit risk measurement of counterparties and limit management processes and credit risk measurements for portfolios. All loan customers of Shinhan Bank are evaluated and managed with credit ratings. Retail customers are evaluated by summing up the information of personal information the bank's internal information and external credit information, and the corporate customers are evaluated by considering financial and non-financial items such as industrial risk, operating risk, and management risk. The evaluated credit rating is used for credit approval, limit management, pricing, credit loss provisioning, etc., and is the basis for credit risk management. The credit evaluation system is divided into an evaluation system for retail customers, a SOHO evaluation system, and an evaluation system for corporate customers. It is subdivided and refined by each model to reflect the Basel III requirements. The corporate credit decision is based on a collective decision-making system, making objective and prudent decisions. In the case of a general credit of loans, the credit is approved based on the consultation between branch's RM (Relationship Manager) and loan officers of each business division's headquarters. In the case of a large or important credit, the credit is approved by the review council. In particular, the Credit Deliberation Committee, the highest decision-making body of the loan, reviews for important loans such as large loans. Credits for retail customers are monitored by an automated credit scoring systems (CSS) based on objective statistical methods and bank credit policies.

The Bank operates a regular monitoring system for the regular management of individual loans. The loan officers and RM evaluate the adequacy of the result of the loan review by automatically searching for anticipated insolvent companies among business loan partners, and if necessary, the credit rating of the corporate is requested of an adjustment. In accordance with these procedures, the corporate customers are classified as an early warning company, an observation company, and a normal company, and then are managed differently according to the management guidelines for each risk stage, thereby preventing the insolvency of the loan at an early stage. The financial analysis support system affiliated with a professional credit rating agency supports credit screening and management, and the credit planning department calculates and manages industrial grades, and analyzes and provides industry trends and company information. In order to control the credit risk for the credit portfolio to an appropriate level, credit VaR limits are set and managed for each business and business sector, and to prepare for the credit risk caused by biased exposure to specific sectors, the Group sets and manages exposure limits for each sector by the party, industry, country, etc.

SHINHAN FINANCIAL GROUP CO., LTD. AND SUBSIDIARIES

Notes to the Consolidated Financial Statements

December 31, 2021 and 2020

4. Financial risk management (continued)

(b) Credit risk (continued)

Shinhan Card's basic policy on credit risk is determined by the Risk Management Committee. The Risk Management Committee consists of the Risk Management Officer (CRO) as the chairperson, and is composed of the heads of each business division and supporting division, and the heads of related departments. Apart from the RMC, a credit committee in charge of monitoring corporate credits and other important credits over a certain amount has been established to separate credit policy decisions from credit monitoring.

Shinhan Card's credit rating system is divided into ASS(Application Scoring System) and BSS(Behaviour Scoring System). Unless a customer fall under "rejections due to policy" (such circumstances include delinquency of other credit card companies) and his/her credit rating is above a certain rate, an application of AS is approved. There is a separate screening criterion for credit card customers, who has maintained its relationship with Shinhan Financial Group for a long-term and has a good credit history. In addition, the elements of credit ratings are used as the basis for setting limits when issuing cards. The BSS, which is recalculated monthly, predicts the delinquency probability of cardholders, and utilizes it to monitor members and monitor portfolio risk.

i) Techniques, assumptions and input variables used to measure impairment

i-1) Determining significant increases in credit risk since initial recognition

At the end of each reporting period, the Group assesses whether the credit risk on a financial instrument has increased significantly since initial recognition. When making the assessment, the Group uses the change in the risk of a default occurring over the expected life of the financial instrument instead of the change in the amount of expected credit losses.

To make the assessment, the Group compares the risk of a default occurring on the financial instrument as at the reporting date with the risk of a default occurring on the financial instrument as at the date of initial recognition and considers reasonable and supportable information, that is available without undue cost or effort, and is indicative of significant increases in credit risk since initial recognition. Information includes the default experience data held by the Group and analysis by an internal credit rating expert.

i-1-1) Measuring the risk of default

The Group assigns an internal credit risk rating to each individual exposure based on observable data and historical experiences that have been found to have a reasonable correlation with the risk of default. The internal credit risk rating is determined by considering both qualitative and quantitative factors that indicate the risk of default, which may vary depending on the nature of the exposure and the type of borrower.

i-1-2) Measuring term structure of probability of default

Internal credit risk rating is the main variable inputs to determine the duration structure for the risk of default. The Group accumulates information after analyzing the information regarding exposure to credit risk and default information by the type of product and borrower and results of internal credit risk assessment. For some portfolios, the Group uses information obtained from external credit rating agencies when performing these analyses.

The Group applies statistical techniques to estimate the probability of default for the remaining life of the exposure from the accumulated data and to estimate changes in the estimated probability of default over time.

SHINHAN FINANCIAL GROUP CO., LTD. AND SUBSIDIARIES

Notes to the Consolidated Financial Statements

December 31, 2021 and 2020

4. **Financial risk management (continued)**

(b) **Credit risk (continued)**

i) *Techniques, assumptions and input variables used to measure impairment (continued)*

i-1-3) Significant increases in credit risk

The Group uses the indicators defined as per portfolio to determine the significant increase in credit risk and such indicators generally consist of changes in the risk of default estimated from changes in the internal credit risk rating, qualitative factors, days of delinquency, and others. The method used to determine whether credit risk of financial instruments has significantly increased after the initial recognitions is summarized as follows:

<u>Corporate exposures</u>	<u>Retail exposures</u>	<u>Card exposures</u>
Significant change in credit ratings Continued past due more than 30 days	Significant change in credit ratings Continued past due more than 30 days	Significant change in credit ratings Continued past due more than 7 days(personal card)
Loan classification of precautionary or below	Loan classification of precautionary or below	Loan classification of precautionary or below
Borrower with early warning signals	Borrower with early warning signals	Specific pool segment
Negative net assets	Specific pool segment	
Adverse audit opinion or disclaimer of opinion	Collective loans for housing for which the constructors are insolvent	
Interest coverage ratio below 1 for a consecutive period of three years or negative cash flows from operating activities for a consecutive period of two years	Loans with identified indicators for significant increases in other credit risk	
Loans with identified indicators for significant increases in other credit risk		

The Group assumes that the credit risk of the financial instrument has been increased significantly since initial recognition if a specific exposure is past due more than 30 days (except, for a specific portfolio if it is past due more than 7 days). The Group counts the number of days past due from the earliest date on which the Group fails to fully receive the contractual payments from the borrower, and does not take into account the grace period granted to the borrower.

The Group regularly reviews the criteria for determining if there have been significant increases in credit risk from the following perspective:

- A significant increase in credit risk shall be identified prior to the occurrence of default.
- The criteria established to judge the significant increase in credit risk shall have a more predictive power than the criteria for days of delinquency.

SHINHAN FINANCIAL GROUP CO., LTD. AND SUBSIDIARIES

Notes to the Consolidated Financial Statements

December 31, 2021 and 2020

4. Financial risk management (continued)

(b) Credit risk (continued)

i) Techniques, assumptions and input variables used to measure impairment (continued)

i-2) Modified financial assets

If the contractual cash flows on a financial asset have been modified through renegotiation and the financial asset is not derecognized, the Group assesses whether there has been a significant increase in the credit risk of the financial instrument by comparing the risk of a default occurring at initial recognition based on the original, unmodified contractual terms and the risk of a default occurring at the reporting date based on the modified contractual terms.

The Group may adjust the contractual cash flows of loans to customers who are in financial difficulties in order to manage the risk of default and enhance the collectability (hereinafter referred to as 'debt restructuring'). These adjustments generally involve extension of maturity, changes in interest payment schedule, and changes in other contractual terms.

Debt restructuring is a qualitative indicator of a significant increase in credit risk and the Group recognizes lifetime expected credit losses for the exposure expected to be the subject of such adjustments. If a borrower faithfully makes payments of contractual cash flows that are modified in accordance with the debt restructuring or if the borrower's internal credit rating has recovered to the level prior to the recognition of the lifetime expected credit losses, the Group recognizes the 12-month expected credit losses for that exposure again.

i-3) Risk of default

The Group considers a financial asset to be in default if it meets one or more of the following conditions:

- If a borrower is overdue 90 days or more from the contractual payment date,
- If the Group judges that it is not possible to recover principal and interest without enforcing the collateral on a financial asset

The Group uses the following indicators when determining whether a borrower is in default:

- Qualitative factors (e.g. breach of contractual terms),
- Quantitative factors (e.g. if the same borrower does not perform more than one payment obligations to the Group, the number of days past due per payment obligation. However, in the case of a specific portfolio, the Group uses the number of days past due for each financial instrument),
- Internal observation data and external data

The definition of default applied by the Group generally conforms to the definition of default defined for regulatory capital management purposes; however, depending on the situations, the information used to determine whether a default has occurred and the extent thereof may vary.

SHINHAN FINANCIAL GROUP CO., LTD. AND SUBSIDIARIES

Notes to the Consolidated Financial Statements

December 31, 2021 and 2020

4. **Financial risk management (continued)**

(b) **Credit risk (continued)**

i) *Techniques, assumptions and input variables used to measure impairment (continued)*

i-4) Reflection of forward-looking information

The Group reflects future forward-looking information presented by a group of internal experts based on various information when measuring expected credit losses. The Group utilizes economic forecasts disclosed by domestic and foreign research institutes, governments, and public institutions to predict forward-looking information.

The Group reflects future macroeconomic conditions anticipated from a neutral standpoint that is free from bias in measuring expected credit losses. Expected credit losses in this respect reflect conditions that are most likely to occur and are based on the same assumptions that the Group used in its business plan and management strategy.

The Group analyzed the data experienced in the past, derived correlations between major macroeconomic variables and credit risks required for predicting credit risk and credit loss for each portfolio, and then reflected future forecast information through regression estimation. To reflect the COVID-19 economic situation, the Group has reviewed the 3 scenarios of upside, central and downside to reflect the final forward-looking information. For the years ended December 31, 2021 and 2020, macroeconomic variables used by the Group are as follows for each scenario.

<December, 31, 2021>

① **Upside scenario**

Major variables(*1)	Correlation between credit risks	2021.4Q(*2)	2022			
			1Q	2Q	3Q	4Q
GDP growth rate(YoY %)	(-)	4.1	3.0	3.1	3.8	3.7
Private consumption index(YoY %)	(-)	6.3	5.1	2.5	3.7	3.8
Facility investment growth rate(YoY %)	(-)	4.1	0.5	1.2	5.0	5.1
Consumer price index growth rate(%)	(-)	3.6	2.6	2.4	2.0	2.0
Balance on current account(billion dollars)	(-)	202.0	230.0	200.0	220.0	230.0
Government bond 3y yields(%)	-	1.87	1.90	1.90	2.00	2.00

② **Central scenario**

Major variables(*1)	Correlation between credit risks	2021.4Q(*2)	2022			
			1Q	2Q	3Q	4Q
GDP growth rate(YoY %)	(-)	4.1	2.3	2.4	3.0	3.4
Private consumption index(YoY %)	(-)	6.3	4.4	1.8	2.9	3.5
Facility investment growth rate(YoY %)	(-)	4.1	0.2	0.8	4.5	4.9
Consumer price index growth rate(%)	(-)	3.6	2.7	2.5	2.2	2.0
Balance on current account(billion dollars)	(-)	202.0	220.0	180.0	200.0	220.0
Government bond 3y yields(%)	-	1.87	1.80	1.80	1.90	1.90

SHINHAN FINANCIAL GROUP CO., LTD. AND SUBSIDIARIES

Notes to the Consolidated Financial Statements

December 31, 2021 and 2020

4. **Financial risk management (continued)**

(b) **Credit risk (continued)**

i) *Techniques, assumptions and input variables used to measure impairment (continued)*

i-4) Reflection of forward-looking information (continued)

③ Downside scenario

Major variables(*1)	Correlation between credit risks	2021.4Q(*2)	2022			
			1Q	2Q	3Q	4Q
GDP growth rate(YoY %)	(-)	4.1	1.3	1.3	1.8	3.1
Private consumption index(YoY %)	(-)	6.3	3.4	0.7	1.8	3.1
Facility investment growth rate(YoY %)	(-)	4.1	(0.5)	0.3	4.3	4.5
Consumer price index growth rate(%)	(-)	3.6	3.2	3.0	3.0	2.8
Balance on current account(billion dollars)	(-)	202.0	200.0	170.0	180.0	200.0
Government bond 3y yields(%)	-	1.87	2.00	2.00	2.20	2.40

(*1) Shinhan Bank applied the GDP growth rate and private consumption index as the major variables. In addition, Shinhan Card applied the GDP growth rate, facility investment growth rate, consumer price index growth rate, and balance on current account as the major variables. In addition to the table above, the Group has selected additional forecasts for the KOSPI.

(*2) Considering the default forecast period, the Group reflected the future economic outlook.

(*3) The macroeconomic outlook figures are estimated by the Group for the purpose of calculating expected credit losses based on information from domestic and foreign research institutes. Therefore, it could be different from other institutions' estimates.

<December 31, 2020>

① Upside scenario

Major variables(*1)	Correlation between credit risks	2020.4Q(*2)	2021			
			1Q	2Q	3Q	4Q
GDP growth rate(YoY %)	(-)	(2.8)	0.0	3.9	3.0	4.3
Private consumption index(YoY %)	(-)	(4.8)	3.0	2.3	3.5	4.1
Facility investment growth rate(YoY %)	(-)	3.5	5.5	6.5	1.5	5.0
Consumer price index growth rate(%)	(-)	0.3	0.6	0.9	0.8	0.9
Balance on current account(billion dollars)	(-)	170.0	130.0	160.0	190.0	180.0
Government bond 3y yields(%)	-	0.90	1.00	1.00	1.10	1.10

SHINHAN FINANCIAL GROUP CO., LTD. AND SUBSIDIARIES

Notes to the Consolidated Financial Statements

December 31, 2021 and 2020

4. **Financial risk management (continued)**

(b) **Credit risk (continued)**

i) *Techniques, assumptions and input variables used to measure impairment (continued)*

i-4) Reflection of forward-looking information (continued)

② Central scenario

Major variables(*1)	Correlation between credit risks	2020.4Q(*2)	2021			
			1Q	2Q	3Q	4Q
GDP growth rate(YoY %)	(-)	(2.8)	(0.7)	3.6	2.5	3.7
Private consumption index(YoY %)	(-)	(4.8)	2.6	2.1	3.0	3.5
Facility investment growth rate(YoY %)	(-)	3.5	5.0	6.0	0.8	4.5
Consumer price index growth rate(%)	(-)	0.3	0.5	0.9	0.7	0.8
Balance on current account(billion dollars)	(-)	170.0	120.0	150.0	180.0	170.0
Government bond 3y yields(%)	-	0.90	1.00	1.00	1.00	1.00

③ Downside scenario

Major variables(*1)	Correlation between credit risks	2020.4Q(*2)	2021			
			1Q	2Q	3Q	4Q
GDP growth rate(YoY %)	(-)	(2.8)	(1.5)	2.3	1.7	3.0
Private consumption index(YoY %)	(-)	(4.8)	1.9	1.1	2.6	3.4
Facility investment growth rate(YoY %)	(-)	3.5	3.5	4.5	(1.0)	3.0
Consumer price index growth rate(%)	(-)	0.3	0.4	0.8	0.6	0.7
Balance on current account(billion dollars)	(-)	170.0	110.0	140.0	170.0	160.0
Government bond 3y yields(%)	-	0.90	1.10	1.10	1.10	1.10

(*1) Shinhan Bank applied the private consumption index and facility investment growth rate as the major variables. In addition, Shinhan Card applied the GDP growth rate, consumer price index growth rate, facility investment growth rate, consumer price index growth rate, balance on current account, and government bond 3y yields as the major variables. In addition to the table above, the Group has selected additional forecasts for the KOSPI.

(*2) Considering the default forecast period, the Group reflected the future economic outlook.

(*3) The macroeconomic outlook figures are estimated by the Group for the purpose of calculating expected credit losses based on information from domestic and foreign research institutes. Therefore, it could be different from other institutions' estimates.

SHINHAN FINANCIAL GROUP CO., LTD. AND SUBSIDIARIES

Notes to the Consolidated Financial Statements

December 31, 2021 and 2020

4. Financial risk management (continued)

(b) Credit risk (continued)

i) Techniques, assumptions and input variables used to measure impairment (continued)

i-4) Reflection of forward-looking information (continued)

The predicted correlations between the macroeconomic variables and the risk of default, used by the Group, are derived based on long-term data over the past ten years.

The recent historical default rate is an important reference when estimating the default rate in consideration of the future economic outlook. Economic indicators have worsened in 2021 due to the economic contraction caused by the COVID-19. However, the historical default rate of the Group's has remained stable because of various government support in response to the COVID-19. The Group manages the credit risk through classifying borrowers in moratorium of interest payments and moratorium of repayment that is one of the financial relief programs into Stage2 to reflect the impact of potential insolvency.

The Group has considered multiple economic scenarios in applying forward-looking information to measure the expected credit losses. Assuming a 100% weighting of Upside, Central, and Downside scenarios, the sensitivity to the Group's provision for expected credit loss is not significant.

SHINHAN FINANCIAL GROUP CO., LTD. AND SUBSIDIARIES

Notes to the Consolidated Financial Statements

December 31, 2021 and 2020

4. Financial risk management (continued)

(b) Credit risk (continued)

i-5) Measurement of expected credit losses

Key variables used in measuring expected credit losses are as follows:

- Probability of default (“PD”)
- Loss given default (“LGD”)
- Exposure at default (“EAD”)

These variables have been estimated from historical experience data by using the statistical techniques developed internally by the Group and have been adjusted to reflect forward-looking information.

Estimates of PD over a specified period are estimated by reflecting characteristics of counterparties and their exposure, based on a statistical model at a specific point of time. The Group uses its own information to develop a statistical credit assessment model used for the estimation, and additional information observed in the market is considered for some portfolios such as a group of large corporates. When a counterparty or exposure is concentrated in specific grades, the method of measuring PD for those grades would be adjusted, and the PD by grade is estimated by considering contract expiration of the exposure.

LGD refers to the expected loss if a borrower defaults. The Group calculates LGD based on the experience recovery rate measured from past default exposures. The model for measuring LGD is developed to reflect type of collateral, seniority of collateral, type of borrower, and cost of recovery. In particular, LGD for retail loan products uses loan to value (LTV) as a key variable. The recovery rate reflected in the LGD calculation is based on the present value of recovery amount, discounted at the effective interest rate.

EAD refers to the expected exposure at the time of default. The Group derives EAD reflecting a rate at which the current exposure is expected to be used additionally up to the point of default within the contractual limit. EAD of financial assets is equal to the total carrying value of the asset, and EAD of loan commitments or financial guarantee contracts is calculated as the sum of the amount expected to be used in the future.

In measuring expected credit losses on financial assets, the Group uses the contractual maturity as the period subject to expected credit loss measurement. The contractual maturity is computed taking into account the extension right held by the borrower.

Risk factors of PD, LGD and EAD are collectively estimated according to the following criteria:

- Type of products
- Internal credit risk rating
- Type of collateral
- Loan to value (“LTV”)
- Industry that the borrower belongs to
- Location of the borrower or collateral
- Days of delinquency

The criteria classifying groups is periodically reviewed to maintain homogeneity of the group and adjusted if necessary. The Group uses external benchmark information to supplement internal information for a particular portfolio that did not have sufficient internal data accumulated from the past experience.

SHINHAN FINANCIAL GROUP CO., LTD. AND SUBSIDIARIES

Notes to the Consolidated Financial Statements

December 31, 2021 and 2020

(In millions of won)

4. Financial risk management (continued)

(b) Credit risk (continued)

i) Techniques, assumptions and input variables used to measure impairment (continued)

i-6) Write-off of financial assets

The Group writes off a portion of or entire loan or debt security that is not expected to receive its principal and interest. In general, the Group conducts write-off when it is deemed that the borrower has no sufficient resources or income to repay the principal and interest. Such determination on write-off is carried out in accordance with the internal rules of the Group and is carried out with the approval of an external institution, if necessary. Apart from write-off, the Group may continue to exercise its right of collection under its own recovery policy even after the write-off of financial assets.

ii) Maximum exposure to credit risk

Exposure to credit risk is the exposure related to due from banks, loans, investments in debt securities, derivative transactions, off-balance sheet accounts such as loan commitment. The exposures of due from banks and loans are classified into government, bank, corporation or retail based on the exposure classification criteria of BASEL III credit risk weights, and the net carrying value, excluding provisions, is presented as the maximum amount that can be exposed by credit risk.

The Group's maximum exposure to credit risk without taking into account of any collateral held or other credit enhancements as of December 31, 2021 and 2020 is as follows:

	<u>December 31, 2021</u>	<u>December 31, 2020</u>
Due from banks and loans at amortized cost (*1),(*)3):		
Banks	₩ 14,166,508	17,016,263
Retail	186,358,002	170,314,316
Government/Public sector/Central bank	15,251,465	24,778,332
Corporations	172,527,573	152,895,324
Card receivable	25,065,621	22,822,546
	<u>413,369,169</u>	<u>387,826,781</u>
Due from banks and loans at fair value through profit or loss(*3):		
Banks	34,262	93,109
Corporations	1,683,344	1,986,804
	<u>1,717,606</u>	<u>2,079,913</u>
Securities at fair value through profit or loss	58,310,838	55,275,031
Securities at fair value through other comprehensive income	63,806,919	57,409,433
Securities at amortized cost(*1)	49,930,076	47,282,623
Derivative assets	3,799,189	5,633,915
Other financial assets(*1),(*)2)	23,238,932	20,341,191
Guarantee contracts(*4)	5,399,286	4,481,506
Loan commitments and other credit liabilities	193,853,866	187,067,821
	<u>₩ 813,425,881</u>	<u>767,398,214</u>

(*1) The maximum exposure amounts for due from banks, loans, securities at amortized cost and other financial assets at amortized cost are recorded as net of allowances.

(*2) Other financial assets mainly comprise of accounts receivable, accrued income, deposits, domestic exchange settlement debit and suspense payments.

(*3) Classified as similar credit risk group based on calculation of the BIS ratio under new Basel Capital Accord (Basel III).

(*4) These amounts represents financial guarantees, and the non-financial guarantees amount to ₩ 11,346,421 million and ₩ 10,799,393 million as of December 31, 2021 and 2020.

SHINHAN FINANCIAL GROUP CO., LTD. AND SUBSIDIARIES

Notes to the Consolidated Financial Statements

December 31, 2021 and 2020

(In millions of won)

4. Financial risk management (continued)

(b) Credit risk (continued)

iii) The maximum amount of exposure to credit risk by type of collateral as of December, 31, 2021 and 2020 is as follows:

Classification	December 31, 2021			
	12 months Expected credit loss	Life time expected credit loss		Total
		Not impaired	Impaired	
Guarantee	₩ 61,890,908	8,354,723	214,589	70,460,220
Deposits and Savings	2,166,075	285,965	2,446	2,454,486
Property and equipment	1,560,567	416,545	20,162	1,997,274
Real estate	127,505,563	14,318,098	256,972	142,080,633
Securities	1,906,005	128,293	7	2,034,305
Others	5,035,546	-	5,495	5,041,041
Total	₩ 200,064,664	23,503,624	499,671	224,067,959

Classification	December 31, 2020			
	12 months Expected credit loss	Life time expected credit loss		Total
		Not impaired	Impaired	
Guarantee	₩ 36,355,387	5,944,417	185,777	42,485,581
Deposits and Savings	1,258,934	313,723	1,509	1,574,166
Property and equipment	1,301,810	324,098	12,341	1,638,249
Real estate	109,092,694	13,914,172	311,946	123,318,812
Securities	2,181,874	108,718	88,025	2,378,617
Others	4,830,557	-	1,943	4,832,500
Total	₩ 155,021,256	20,605,128	601,541	176,227,925

SHINHAN FINANCIAL GROUP CO., LTD. AND SUBSIDIARIES

Notes to the Consolidated Financial Statements

December 31, 2021 and 2020

(In millions of won)

4. Financial risk management (continued)

(b) Credit risk (continued)

iv) Impairment information by credit risk of financial assets

Details of impaired financial assets due to credit risk as of December 31, 2021 are as follows:

	December 31, 2021								Mitigation of credit risk due to collateral
	12-month expected credit loss		Life time expected credit loss			Total	Allowances	Net	
	Grade 1	Grade 2	Grade 1	Grade 2	Impaired				
Due from banks and loans at amortized cost:									
Banks	₩ 10,793,973	3,278,144	112,254	434	-	14,184,805	(18,297)	14,166,508	133,618
Retail	169,313,467	7,015,361	7,900,192	2,127,173	581,534	186,937,727	(579,725)	186,358,002	126,988,030
Government/Public sector/									
Central bank	14,531,532	710,527	17,433	257	-	15,259,749	(8,284)	15,251,465	9,000
Corporations	101,866,101	44,060,819	10,743,965	16,702,928	853,977	174,227,790	(1,700,217)	172,527,573	93,682,859
Card receivable	18,793,517	2,541,833	1,829,837	2,350,634	428,068	25,943,889	(878,268)	25,065,621	8,774
	<u>315,298,590</u>	<u>57,606,684</u>	<u>20,603,681</u>	<u>21,181,426</u>	<u>1,863,579</u>	<u>416,553,960</u>	<u>(3,184,791)</u>	<u>413,369,169</u>	<u>220,822,281</u>
Securities at fair value through other comprehensive income(*)	56,176,008	7,478,125	-	152,786	-	63,806,919	-	63,806,919	-
Securities at amortized cost	48,305,398	1,605,335	-	36,290	-	49,947,023	(16,947)	49,930,076	-
	<u>₩ 419,779,996</u>	<u>66,690,144</u>	<u>20,603,681</u>	<u>21,370,502</u>	<u>1,863,579</u>	<u>530,307,902</u>	<u>(3,201,738)</u>	<u>527,106,164</u>	<u>220,822,281</u>

(*) Credit loss allowance recognized as other comprehensive income of securities at fair value through other comprehensive income amounted to ₩ 37,486 million as of December 31, 2021.

SHINHAN FINANCIAL GROUP CO., LTD. AND SUBSIDIARIES

Notes to the Consolidated Financial Statements

December 31, 2021 and 2020

(In millions of won)

4. Financial risk management (continued)

(b) Credit risk (continued)

iv) Impairment information by credit risk of financial assets (continued)

Details of impaired financial assets due to credit risk as of December 31, 2020 are as follows:

	December 31, 2020								Mitigation of credit risk due to collateral
	12-month expected credit loss		Life time expected credit loss			Total	Allowances	Net	
	Grade 1	Grade 2	Grade 1	Grade 2	Impaired				
Due from banks and loans at amortized cost:									
Banks	₩ 14,935,722	1,996,948	87,084	10,027	-	17,029,781	(13,518)	17,016,263	29,994
Retail	152,159,976	8,385,069	6,062,587	3,686,863	574,354	170,868,849	(554,533)	170,314,316	91,711,254
Government/Public sector/									
Central bank	23,849,701	834,912	96,183	1,748	-	24,782,544	(4,212)	24,778,332	9,000
Corporations	93,740,349	34,637,533	11,391,410	13,758,332	982,037	154,509,661	(1,614,337)	152,895,324	83,580,715
Card receivable	16,995,332	2,304,536	1,754,723	2,197,877	454,451	23,706,919	(884,373)	22,822,546	6,845
	<u>301,681,080</u>	<u>48,158,998</u>	<u>19,391,987</u>	<u>19,654,847</u>	<u>2,010,842</u>	<u>390,897,754</u>	<u>(3,070,973)</u>	<u>387,826,781</u>	<u>175,337,808</u>
Securities at fair value through other comprehensive income(*)	48,506,057	8,636,241	-	267,135	-	57,409,433	-	57,409,433	-
Securities at amortized cost	45,888,769	1,404,340	-	-	-	47,293,109	(10,486)	47,282,623	-
	<u>₩ 396,075,906</u>	<u>58,199,579</u>	<u>19,391,987</u>	<u>19,921,982</u>	<u>2,010,842</u>	<u>495,600,296</u>	<u>(3,081,459)</u>	<u>492,518,837</u>	<u>175,337,808</u>

(*) Credit loss allowance recognized as other comprehensive income of securities at fair value through other comprehensive income amounted to ₩ 23,171 million as of December 31, 2020.

SHINHAN FINANCIAL GROUP CO., LTD. AND SUBSIDIARIES

Notes to the Consolidated Financial Statements

December 31, 2021 and 2020

(In millions of won)

4. Financial risk management (continued)

(b) Credit risk (continued)

v) Credit risk exposures per credit grade of off-balance items

Credit risk exposures per credit grade of off-balance items as of December 31, 2021 and 2020 are as follows:

		December 31, 2021			
		Grade 1	Grade 2	Impaired	Total
Guarantee contracts(*):					
12-month expected credit loss	₩	3,469,002	1,382,415	-	4,851,417
Life time expected credit loss		342,224	205,179	-	547,403
Impaired		-	-	466	466
		<u>3,811,226</u>	<u>1,587,594</u>	<u>466</u>	<u>5,399,286</u>
Loan commitment and other credit line					
12-month expected credit loss		160,307,100	23,370,613	-	183,677,713
Life time expected credit loss		7,406,324	2,759,057	-	10,165,381
Impaired		-	-	10,772	10,772
		<u>167,713,424</u>	<u>26,129,670</u>	<u>10,772</u>	<u>193,853,866</u>
	₩	<u>171,524,650</u>	<u>27,717,264</u>	<u>11,238</u>	<u>199,253,152</u>
		December 31, 2020			
		Grade 1	Grade 2	Impaired	Total
Guarantee contracts(*):					
12-month expected credit loss	₩	2,884,641	1,110,945	-	3,995,586
Life time expected credit loss		308,785	176,977	-	485,762
Impaired		-	-	158	158
		<u>3,193,426</u>	<u>1,287,922</u>	<u>158</u>	<u>4,481,506</u>
Loan commitment and other credit line					
12-month expected credit loss		156,787,448	20,715,236	-	177,502,684
Life time expected credit loss		6,738,016	2,822,003	-	9,560,019
Impaired		-	-	5,118	5,118
		<u>163,525,464</u>	<u>23,537,239</u>	<u>5,118</u>	<u>187,067,821</u>
	₩	<u>166,718,890</u>	<u>24,825,161</u>	<u>5,276</u>	<u>191,549,327</u>

(*) These amounts represents financial guarantees, and the non-financial guarantees amount to ₩ 11,346,421 million and ₩ 10,799,393 million as of December 31, 2021 and 2020, respectively.

vi) Credit qualities are classified based on the internal credit rating as follows:

Type of Borrower	Grade 1	Grade 2
Individuals	Probability of default below 2.25% for each pool	Probability of default 2.25% or above for each pool
Government/Public agency/Central bank	OECD sovereign credit rating of 6 or above	OECD sovereign credit rating of below 6
Banks and Corporations (Including credit card bond)	Internal credit rating of BBB+ or above	Internal credit rating of below BBB+
Card receivables (Individuals)	Behavior scoring system of 7 grade or above	Behavior scoring system of below 7 grade

SHINHAN FINANCIAL GROUP CO., LTD. AND SUBSIDIARIES

Notes to the Consolidated Financial Statements

December 31, 2021 and 2020

(In millions of won)

4. Financial risk management (continued)

(b) Credit risk (continued)

vii) Credit risk exposures per credit quality of derivative assets

Credit quality of derivative assets as of December 31, 2021 and 2020 are as follows:

		<u>December 31, 2021</u>	<u>December 31, 2020</u>
Grade 1	₩	3,201,912	4,994,809
Grade 2		597,277	639,106
	₩	<u>3,799,189</u>	<u>5,633,915</u>

(*) Credit quality of derivative assets is classified based on the internal credit ratings.

SHINHAN FINANCIAL GROUP CO., LTD. AND SUBSIDIARIES

Notes to the Consolidated Financial Statements

December 31, 2021 and 2020

(In millions of won)

4. Financial risk management (continued)

(b) Credit risk (continued)

viii) *Concentration by geographic location*

An analysis of concentration by geographic location for financial instrument, net of allowance, as of December 31, 2021 and 2020 are as follows:

Classification(*1)	December 31, 2021								
	Korea	USA	UK	Japan	Germany	Vietnam	China	Other	Total
Due from banks and loans at amortized cost									
Banks	₩ 4,310,888	1,525,158	235,591	450,689	530,688	1,676,080	2,677,445	2,759,969	14,166,508
Retail	175,777,754	392,882	7,683	4,338,281	3,111	2,412,670	1,944,105	1,481,516	186,358,002
Government/Public sector/Central bank	11,807,591	796,405	-	1,279,012	217,773	248,301	462,308	440,075	15,251,465
Corporations	151,625,249	3,684,068	254,051	4,375,807	94,186	3,012,133	2,947,746	6,534,333	172,527,573
Card receivable	24,832,367	10,435	462	2,033	233	170,929	32,281	16,881	25,065,621
	<u>368,353,849</u>	<u>6,408,948</u>	<u>497,787</u>	<u>10,445,822</u>	<u>845,991</u>	<u>7,520,113</u>	<u>8,063,885</u>	<u>11,232,774</u>	<u>413,369,169</u>
Deposits and loans at FVTPL									
Banks	-	34,262	-	-	-	-	-	-	34,262
Corporations	1,113,229	282,513	-	19,274	-	-	-	268,328	1,683,344
	<u>1,113,229</u>	<u>316,775</u>	<u>-</u>	<u>19,274</u>	<u>-</u>	<u>-</u>	<u>-</u>	<u>268,328</u>	<u>1,717,606</u>
Securities measured at FVTPL	53,942,627	2,359,478	255,023	91,766	19,048	27,613	76,107	1,539,176	58,310,838
Securities at FVOCI	59,353,250	1,871,526	164,340	250,768	52,199	120,884	679,527	1,314,425	63,806,919
Securities at amortized cost	46,896,258	777,546	-	244,149	-	902,377	80,041	1,029,705	49,930,076
	<u>529,659,213</u>	<u>11,734,273</u>	<u>917,150</u>	<u>11,051,779</u>	<u>917,238</u>	<u>8,570,987</u>	<u>8,899,560</u>	<u>15,384,408</u>	<u>587,134,608</u>
Off-balance accounts									
Guarantees(*2)	4,991,349	45,650	2,099	821	4,384	95,565	246,080	13,338	5,399,286
Loan commitments and other liabilities related to credit	182,701,367	686,381	260,036	771,183	87,080	2,772,750	2,157,388	4,417,681	193,853,866
	<u>₩ 187,692,716</u>	<u>732,031</u>	<u>262,135</u>	<u>772,004</u>	<u>91,464</u>	<u>2,868,315</u>	<u>2,403,468</u>	<u>4,431,019</u>	<u>199,253,152</u>

(*1) The following accounts are the net carrying value less provision for doubtful accounts.

(*2) These amounts represents financial guarantees, and the non-financial guarantees amount to ₩ 11,346,421 million as of December 31, 2021.

SHINHAN FINANCIAL GROUP CO., LTD. AND SUBSIDIARIES

Notes to the Consolidated Financial Statements

December 31, 2021 and 2020

(In millions of won)

4. Financial risk management (continued)

(b) Credit risk (continued)

viii) *Concentration by geographic location (continued)*

An analysis of concentration by geographic location for financial instrument, net of allowance, as of December 31, 2021 and 2020 are as follows (continued):

Classification(*1)	December 31, 2020								
	Korea	USA	UK	Japan	Germany	Vietnam	China	Other	Total
Due from banks and loans at amortized cost									
Banks	₩ 6,990,520	823,698	156,002	784,538	316,293	1,166,397	2,889,115	3,889,700	17,016,263
Retail	161,434,788	392,499	6,724	4,124,680	2,386	1,780,361	1,329,067	1,243,811	170,314,316
Government/Public sector/Central bank	20,998,640	952,215	-	1,418,805	121,663	209,395	441,863	635,751	24,778,332
Corporations	133,827,181	3,278,234	435,135	3,796,824	103,647	2,319,327	3,039,177	6,095,799	152,895,324
Card receivable	22,614,285	8,867	351	1,983	194	152,141	27,926	16,799	22,822,546
	<u>345,865,414</u>	<u>5,455,513</u>	<u>598,212</u>	<u>10,126,830</u>	<u>544,183</u>	<u>5,627,621</u>	<u>7,727,148</u>	<u>11,881,860</u>	<u>387,826,781</u>
Deposits and loans at FVTPL									
Banks	61,476	31,633	-	-	-	-	-	-	93,109
Corporations	1,057,690	466,812	-	19,807	-	744	-	441,751	1,986,804
	<u>1,119,166</u>	<u>498,445</u>	<u>-</u>	<u>19,807</u>	<u>-</u>	<u>744</u>	<u>-</u>	<u>441,751</u>	<u>2,079,913</u>
Securities measured at FVTPL	51,574,884	2,129,355	198,567	46,086	4,486	24,539	168,863	1,128,251	55,275,031
Securities at FVOCI	53,386,556	1,464,611	112,001	221,917	36,412	172,904	886,080	1,128,952	57,409,433
Securities at amortized cost	44,537,890	723,287	-	243,592	-	710,106	45,121	1,022,627	47,282,623
	<u>496,483,910</u>	<u>10,271,211</u>	<u>908,780</u>	<u>10,658,232</u>	<u>585,081</u>	<u>6,535,914</u>	<u>8,827,212</u>	<u>15,603,441</u>	<u>549,873,781</u>
Off-balance accounts									
Guarantees(*2)	3,818,973	65,164	6,198	1,344	6,041	95,793	363,042	124,951	4,481,506
Loan commitments and other liabilities related to credit	178,311,828	528,596	275,629	645,794	64,050	1,042,458	2,443,779	3,755,687	187,067,821
	<u>₩ 182,130,801</u>	<u>593,760</u>	<u>281,827</u>	<u>647,138</u>	<u>70,091</u>	<u>1,138,251</u>	<u>2,806,821</u>	<u>3,880,638</u>	<u>191,549,327</u>

(*1) The following accounts are the net carrying value less provision for doubtful accounts.

(*2) These amounts represents financial guarantees, and the non-financial guarantees amount to ₩ 10,799,393 million as of December 31, 2020.

SHINHAN FINANCIAL GROUP CO., LTD. AND SUBSIDIARIES

Notes to the Consolidated Financial Statements

December 31, 2021 and 2020

(In millions of won)

4. Financial risk management (continued)

ix) *Concentration by industry sector*

An analysis of concentration by industry sector of financial instrument, net of allowance, as of and December 31, 2021 and 2020 is as follows:

Classification(*1)	December 31, 2021								
	Finance and insurance	Manu-facturing	Retail and wholesale	Real estate and business	Construction service	Lodging and Restaurant	Other	Retail customers	Total
Due from banks and loans at amortized cost:									
Banks	₩ 13,447,829	-	-	-	-	-	718,679	-	14,166,508
Retail	-	-	-	-	-	-	-	186,358,002	186,358,002
Government/Public sector/Central bank	15,216,403	-	-	1,797	-	-	33,265	-	15,251,465
Corporations	13,384,083	53,134,572	21,167,564	41,106,836	3,727,338	6,544,166	33,463,014	-	172,527,573
Card receivable	51,123	252,973	228,900	46,896	45,568	29,713	1,899,301	22,511,147	25,065,621
	<u>42,099,438</u>	<u>53,387,545</u>	<u>21,396,464</u>	<u>41,155,529</u>	<u>3,772,906</u>	<u>6,573,879</u>	<u>36,114,259</u>	<u>208,869,149</u>	<u>413,369,169</u>
Due from banks and loans at FVTPL									
Banks	34,262	-	-	-	-	-	-	-	34,262
Corporations	986,736	492,598	15,107	78,753	22,537	2,637	84,976	-	1,683,344
	<u>1,020,998</u>	<u>492,598</u>	<u>15,107</u>	<u>78,753</u>	<u>22,537</u>	<u>2,637</u>	<u>84,976</u>	<u>-</u>	<u>1,717,606</u>
Securities at fair value through profit or loss	33,769,892	3,248,846	1,169,038	773,687	299,972	152,341	18,897,062	-	58,310,838
Securities at fair value through other comprehensive income	27,034,695	3,529,756	523,631	775,967	1,144,998	30,928	30,766,944	-	63,806,919
Securities at amortized cost	10,309,318	-	-	1,074,393	1,249,070	-	37,297,295	-	49,930,076
	<u>114,234,341</u>	<u>60,658,745</u>	<u>23,104,240</u>	<u>43,858,329</u>	<u>6,489,483</u>	<u>6,759,785</u>	<u>123,160,536</u>	<u>208,869,149</u>	<u>587,134,608</u>
Off-balance accounts									
Guarantees(*2)	775,357	948,440	396,571	126,393	36,001	56,105	3,059,953	466	5,399,286
Loan commitments and other liabilities related to credit	15,445,541	25,389,003	8,908,201	3,676,457	2,213,871	499,633	20,404,848	117,316,312	193,853,866
	<u>₩ 16,220,898</u>	<u>26,337,443</u>	<u>9,304,772</u>	<u>3,802,850</u>	<u>2,249,872</u>	<u>555,738</u>	<u>23,464,801</u>	<u>117,316,778</u>	<u>199,253,152</u>

(*1) The composition details by industry are net book value less allowances.

(*2) These amounts represents financial guarantees, and the non-financial guarantees amount to ₩ 11,346,421 million as of December 31, 2021.

SHINHAN FINANCIAL GROUP CO., LTD. AND SUBSIDIARIES

Notes to the Consolidated Financial Statements

December 31, 2021 and 2020

(In millions of won)

4. Financial risk management (continued)

ix) *Concentration by industry sector (continued)*

An analysis of concentration by industry sector of financial instrument, net of allowance, as of and December 31, 2021 and 2020 is as follows:

Classification(*1)	December 31, 2020								
	Finance and insurance	Manu-facturing	Retail and wholesale	Real estate and business	Construction service	Lodging and Restaurant	Other	Retail customers	Total
Due from banks and loans at amortized cost:									
Banks	₩ 16,656,030	-	-	-	-	-	360,233	-	17,016,263
Retail	-	-	-	-	-	-	-	170,314,316	170,314,316
Government/Public sector/Central bank	24,671,308	-	-	1,796	-	-	105,228	-	24,778,332
Corporations	10,403,261	48,430,680	18,679,397	35,920,334	3,521,216	6,479,253	29,461,183	-	152,895,324
Card receivable	44,980	169,900	252,537	36,372	38,456	23,150	1,685,293	20,571,858	22,822,546
	<u>51,775,579</u>	<u>48,600,580</u>	<u>18,931,934</u>	<u>35,958,502</u>	<u>3,559,672</u>	<u>6,502,403</u>	<u>31,611,937</u>	<u>190,886,174</u>	<u>387,826,781</u>
Due from banks and loans at FVTPL									
Banks	63,112	-	-	29,997	-	-	-	-	93,109
Corporations	1,114,789	641,554	19,210	51,008	3,000	-	157,243	-	1,986,804
	<u>1,177,901</u>	<u>641,554</u>	<u>19,210</u>	<u>81,005</u>	<u>3,000</u>	<u>-</u>	<u>157,243</u>	<u>-</u>	<u>2,079,913</u>
Securities at fair value through profit or loss	34,294,362	2,978,991	1,223,958	574,547	248,399	46,177	15,908,597	-	55,275,031
Securities at fair value through other comprehensive income	26,528,743	3,448,765	577,781	830,988	974,333	22,643	25,026,180	-	57,409,433
Securities at amortized cost	10,361,913	21,750	-	1,053,779	963,348	-	34,881,833	-	47,282,623
	<u>124,138,498</u>	<u>55,691,640</u>	<u>20,752,883</u>	<u>38,498,821</u>	<u>5,748,752</u>	<u>6,571,223</u>	<u>107,585,790</u>	<u>190,886,174</u>	<u>549,873,781</u>
Off-balance accounts									
Guarantees(*2)	919,485	1,173,940	539,195	149,213	86,624	49,544	1,563,217	288	4,481,506
Loan commitments and other liabilities related to credit	13,474,195	25,825,767	9,652,509	3,619,939	2,159,128	513,565	19,277,732	112,544,986	187,067,821
	<u>₩ 14,393,680</u>	<u>26,999,707</u>	<u>10,191,704</u>	<u>3,769,152</u>	<u>2,245,752</u>	<u>563,109</u>	<u>20,840,949</u>	<u>112,545,274</u>	<u>191,549,327</u>

(*1) The composition details by industry are net book value less allowances.

(*2) These amounts represents financial guarantees, and the non-financial guarantees amount to ₩ 10,799,393 million as of December 31, 2020.

SHINHAN FINANCIAL GROUP CO., LTD. AND SUBSIDIARIES

Notes to the Consolidated Financial Statements

December 31, 2021 and 2020

(In millions of won)

4. Financial risk management (continued)

(c) Market risk

i) Market risk management from trading positions

i-1) Concept of Market risk

Market risk is defined as the risk of loss of trading account position of financial institutions due to changes on market price, such as interest rates, exchange rates and stock prices, etc. and is divided into general market risks and individual risks. A general market risk refers to a loss from price variability caused by events affecting the market as a whole, such as interest rates, exchange rates and stock prices; and an individual risk refers to a loss from price variability related to individual events of securities issuer, such as bonds and stocks.

i-2) Market Risk Management Method

The basic principle of market risk management in the trading sector is to maintain the maximum possible loss due to market risk within a certain level. To this end, the Group sets and operates VaR limits, investment limits, position limits, sensitivity limits, and loss limits from the portfolio to individual desks. These limits are managed daily by the department in charge of risk management, independent from the operating department.

Trading positions refer to securities, foreign exchange positions, and derivative financial instruments held for the purpose of obtaining short-term trading gains. As a method of measuring market risk, VaR (Value at Risk) is typical, and it is a statistical measurement of the potential maximum loss that can occur due to changes in market conditions. VaR calculates the standard method market risk using the Group Market Risk Measurement System (TRMS), and Shinhan Bank and Shinhan Financial Investment use their own internal model market risk calculation system.

Stress tests are conducted to supplement risk measurement by statistical methods and to manage losses that may arise from rapid changes in the economic environment.

Shinhan Bank measures the market risk of linear products, such as stocks and bonds, as well as non-linear products, such as options by applying historical simulation method of 99% confidence level-based VaR. Trading position data is automatically interfaced into management system, and the system conducts VaR measurement and manages the limit. In addition, the Bank sets loss limit, sensitivity limit, investment limit, stress limit, etc. for Trading Department and desks, and monitors daily.

Shinhan Investment measures daily market risk by applying historical simulation VaR method of 99.9% confidence level-based VaR. Historical simulation VaR method does not require assumption on a particular distribution since the method derives scenarios directly from historical market data, and measures non-linear products, such as options, in details. In addition to the VaR limit, the Shinhan Investment sets and manages issuance and transaction limit, and stop-loss limit for each department.

SHINHAN FINANCIAL GROUP CO., LTD. AND SUBSIDIARIES

Notes to the Consolidated Financial Statements

December 31, 2021 and 2020

(In millions of won)

4. Financial risk management (continued)

(c) Market risk (continued)

i) Market risk management from trading positions (continued)

i-2) Managements (continued)

An analysis of the Group's requisite capital in light of the market risk for trading positions as of and for the years ended December 31, 2021 and 2020 based on the standard guidelines for risk management promulgated by the Financial Supervisory Service, is as follows:

		December 31, 2021			
		Average	Maximum	Minimum	December 31
Interest rate risk	₩	587,482	625,298	557,622	576,515
Stock price risk		209,101	231,137	179,415	219,900
Foreign exchange risk		274,140	301,271	245,232	299,909
Commodity risk		8,544	9,571	8,043	8,043
Option volatility risk		16,404	30,244	1,269	19,032
	₩	<u>1,095,671</u>	<u>1,197,521</u>	<u>991,581</u>	<u>1,123,399</u>

		December 31, 2020			
		Average	Maximum	Minimum	December 31
Interest rate risk	₩	525,465	592,668	495,292	592,668
Stock price risk		222,277	240,535	202,036	222,544
Foreign exchange risk		120,088	124,915	113,497	113,497
Commodity risk		13,818	22,982	9,539	9,539
Option volatility risk		8,910	23,224	3,234	3,234
	₩	<u>890,558</u>	<u>1,004,324</u>	<u>823,598</u>	<u>941,482</u>

i-3) Shinhan Bank

The analyses of the ten-day 99% confidence level-based VaR for managing market risk for trading positions of Shinhan Bank as of and for the years ended December 31, 2021 and 2020 are as follows:

		December 31, 2021			
		Average	Maximum	Minimum	December 31
Interest rate risk	₩	28,749	55,773	17,537	28,030
Stock price risk		11,583	21,340	3,850	19,618
Foreign exchange risk (*)		159,165	185,514	136,936	161,978
Option volatility risk		162	368	29	60
Commodity risk		11	151	-	8
Portfolio diversification effect		(25,023)	(52,611)	(13,207)	(17,470)
	₩	<u>174,647</u>	<u>210,535</u>	<u>145,145</u>	<u>192,224</u>

		December 31, 2020			
		Average	Maximum	Minimum	December 31
Interest rate risk	₩	41,165	56,950	28,322	42,867
Stock price risk		27,077	66,254	7,545	7,893
Foreign exchange risk (*)		65,309	83,335	27,668	69,024
Option volatility risk		305	1,073	114	138
Commodity risk		13	170	-	1
Portfolio diversification effect		(27,839)	(53,295)	(14,163)	(25,310)
	₩	<u>106,030</u>	<u>154,487</u>	<u>49,486</u>	<u>94,613</u>

(*) Both trading and non-trading accounts are included since Shinhan Bank manages foreign exchange risk on a total position basis.

SHINHAN FINANCIAL GROUP CO., LTD. AND SUBSIDIARIES

Notes to the Consolidated Financial Statements

December 31, 2021 and 2020

(In millions of won)

4. Financial risk management (continued)

(c) Market risk (continued)

i) Market risk management from trading positions (continued)

i-4) Shinhan Card

The analyses of Shinhan Card's requisite capital in light of the market risk for trading positions as of and for the years ended December 31 2021, and 2020, based on the standard guidelines for risk management promulgated by the Financial Supervisory Service, are as follows:

		December 31, 2021			
		Average	Maximum	Minimum	December 31
Interest rate risk	₩	1,996	2,350	1,700	1,700

		December 31, 2020			
		Average	Maximum	Minimum	December 31
Interest rate risk	₩	2,034	2,400	1,900	2,400

(*) Foreign subsidiaries are excluded from the calculation.

i-5) Shinhan Investment

The analyses of the ten-day 99.9% confidence level-based VaR for managing market risk for trading positions of Shinhan Investment as of and for the years ended December 31, 2021 and 2020 are as follows:

		December 31, 2021			
		Average	Maximum	Minimum	December 31
Interest rate risk	₩	21,079	35,503	7,724	27,207
Stock price risk		31,668	62,315	15,856	33,295
Foreign exchange risk		24,354	43,826	2,548	28,594
Option volatility risk		49,345	96,355	31,155	79,589
Portfolio diversification effect		(47,759)	(104,149)	(7,380)	(58,241)
	₩	78,687	133,850	49,903	110,444

		December 31, 2020			
		Average	Maximum	Minimum	December 31
Interest rate risk	₩	20,512	30,903	12,076	23,551
Stock price risk		26,136	51,509	2,412	36,573
Foreign exchange risk		12,477	46,970	632	15,557
Option volatility risk		43,324	162,008	2,894	57,924
Portfolio diversification effect		(27,223)	(103,405)	634	(38,397)
	₩	75,226	187,985	18,648	95,208

SHINHAN FINANCIAL GROUP CO., LTD. AND SUBSIDIARIES

Notes to the Consolidated Financial Statements

December 31, 2021 and 2020

(In millions of won)

4. Financial risk management (continued)

(c) Market risk (continued)

i) Market risk management from trading positions (continued)

i-6) Shinhan Life Insurance

The analyses of the ten-day 99.9% confidence level-based VaR for managing market risk for trading positions of Shinhan Life Insurance as of and for the years ended December 31, 2021 and 2020 are as follows:

		December 31, 2021			
		Average	Maximum	Minimum	December 31
Interest rate risk	₩	4,161	9,262	457	1,259
Stock price risk		8,938	15,009	1,909	6,303
Foreign exchange risk		7,680	13,746	481	11,404
Option volatility risk		1,252	2,828	26	47
	₩	22,031	40,845	2,873	19,013

<Shinhan Life Insurance>

		December 31, 2020			
		Average	Maximum	Minimum	December 31
Interest rate risk	₩	2,967	6,934	354	619
Stock price risk		10,953	16,592	4,481	13,742
Foreign exchange risk		10,485	21,588	4,665	13,669
Option volatility risk		433	1,096	40	1,089
	₩	24,838	46,210	9,540	29,119

<Orange Life Insurance>

		December 31, 2020			
		Average	Maximum	Minimum	December 31
Foreign exchange risk	₩	17,064	19,597	10,172	17,964
Option volatility risk		73	84	7	73
	₩	17,137	19,681	10,179	18,037

SHINHAN FINANCIAL GROUP CO., LTD. AND SUBSIDIARIES

Notes to the Consolidated Financial Statements

December 31, 2021 and 2020

(In millions of won)

4. Financial risk management (continued)

(c) Market risk (continued)

ii) Interest rate risk management from non-trading positions

ii-1) Principle

Interest rate risk refers to the possibility of a decrease in net interest income or in net asset value that occurs when interest rates fluctuate unfavorably from the Group's financial position. The Group manages changes in net interest income or net asset value that occur due to changes in interest rates by early predicting the factors of interest rate risk fluctuation related to the Group's net interest income and net asset value through the interest rate risk management.

ii-2) Managements

Shinhan Financial Group's major financial subsidiaries manage interest rate risks independently by the risk management organization and the treasury department, and have internal regulations on interest rate risk management strategies, procedures, organization, measurement, and major assumptions.

One of the key indicators of managing interest rate risk is the Earnings at Risk (EaR) from an earning perspective and the Value at Risk (VaR) from an economic value perspective. Interest rate VaR represents the maximum anticipated loss in a net present value calculation, whereas interest rate EaR represents the maximum anticipated loss in a net interest income calculation for the immediately following one-year period, in each case, as a result of negative movements in interest rates.

The precision of risk management system differs by each subsidiary. Interest rate VaR and interest rate EaR are measured by internal method or IRRBB (Interest Rate Risk In The Banking Book), and interest rate risk limits are set and monitored based on the interest rate VaR. In accordance with the amendments in Regulations for Supervision of Financial Holding Companies, the Group measures the interest rate risk using the Basel III based IRRBB, which measures the interest rate risk more precisely than the existing BIS standard framework by segmenting maturities of interest rates, reflecting customer behaviour models and diversifying interest rate shocks. The interest rate VaR scenario based IRRBB measures ① parallel up shock ② parallel down shock ③ steeper shock ④ flattener shock ⑤ short rate up shock ⑥ short rate down shock. By the parallel up shock and parallel down shock, the interest rate VaR scenario measures the scenario value with the largest loss as interest rate risk. Under the existing BIS standard framework, $\pm 200\text{bp}$ parallel shock scenario is applied to all currency. However, as the shock width is set differently by currency and period, interest rate risk is measured significantly by the IRRBB. ((KRW) Parallel $\pm 300\text{bp}$, Short Term $\pm 400\text{bp}$, Long Term $\pm 200\text{bp}$, (USD) Parallel $\pm 200\text{bp}$, Short Term $\pm 300\text{bp}$, Long Term $\pm 150\text{bp}$) In the IRRBB method, the existing interest rate VaR and the interest rate EaR are expressed as Δ EVE (Economic Value of Equity) and Δ NII (Net Interest Income), respectively.

Since impacts of each subsidiary on changes of interest rates are differentiated by portfolios, the Group is preparing to respond proactively while monitoring the financial market and regulatory environment, and making efforts to hedge or reduce interest rate risk. In addition, the subsidiaries conduct the crisis analysis on changes in market interest rates and report it to management and the Group.

In particular, through its ALM (Asset and Liability Management) system, Shinhan Bank measures and manages its interest rate risk based on various analytical measures such as interest rate gap, duration gap and NPV (Net Present Value) and NII (Net Interest Income) simulations, and monitors on a monthly basis its interest rate VaR limits, interest rate EaR (Earnings at Risk) limits and interest rate gap ratio limits.

SHINHAN FINANCIAL GROUP CO., LTD. AND SUBSIDIARIES

Notes to the Consolidated Financial Statements

December 31, 2021 and 2020

(In millions of won)

4. Financial risk management (continued)

(c) Market risk (continued)

ii) Interest rate risk management from non-trading positions (continued):

The details of interest rate VaR and EaR for major subsidiaries for as of December 31, 2021 and 2020 are as follows:

ii-3) Shinhan Bank

		<u>December 31, 2021</u>	<u>December 31, 2020</u>
△EVE (*1)	₩	774,352	468,327
△NII (*2)		96,145	115,221

ii-4) Shinhan Card

		<u>December 31, 2021</u>	<u>December 31, 2020</u>
△EVE (*1)	₩	831,361	463,647
△NII (*2)		672,303	594,210

ii-5) Shinhan Investment

		<u>December 31, 2021</u>	<u>December 31, 2020</u>
△EVE (*1)	₩	186,587	209,929
△NII (*2)		187,548	89,925

ii-6) Shinhan Life Insurance

		<u>December 31, 2021</u>	<u>December 31, 2020</u>	
		<u>Shinhan Life Insurance</u>	<u>Shinhan Life Insurance</u>	<u>Orange Life Insurance</u>
△EVE (*1)	₩	2,751,977	4,140,109	2,007,029
△NII (*2)		84,812	46,073	38,733

(*1) △EVE is the change in economic value of equity capital that can arise from changes in interest rates that affect the present value of assets, liabilities and off-balance sheet items by using the Basel III standard based IRRBB method.

(*2) △NII is the change in net interest income that can occur over the next year due to changes in interest rates by using the Basel III standard based IRRBB method.

SHINHAN FINANCIAL GROUP CO., LTD. AND SUBSIDIARIES

Notes to the Consolidated Financial Statements

December 31, 2021 and 2020

(In millions of won)

4. Financial risk management (continued)

(c) Market risk (continued)

iii) Foreign exchange risk

Exposure to foreign exchange risk can be defined as the difference (net position) between assets and liabilities presented in foreign currency, including derivative financial instruments linked to foreign exchange rate. Foreign exchange risk is a factor that causes market risk of the trading position and is managed by the Group under the market risk management system.

The management of Shinhan Bank's foreign exchange position is centralized at the S&T Center. Dealers in the S&T Center manage Shinhan Bank's overall position within the set limits through spot trading, forward contracts, currency options, futures and swaps and foreign exchange swaps. Shinhan Bank sets a limit for net open positions by currency and the limits for currencies other than the U.S. dollars (USD), Japanese yen (JPY), Euros (EUR) and Chinese yuan (CNY) are set in order to minimize exposures from the other foreign exchange trading.

Foreign currency denominated assets and liabilities as of December 31, 2021 and 2020 are as follows:

	December 31, 2021					Total
	USD	JPY	EUR	CNY	Other	
Assets:						
Cash and due from banks at amortized cost	₩ 4,958,621	1,878,286	479,644	700,378	3,630,253	11,647,182
Due from banks at FVTPL	34,262	-	-	-	-	34,262
Loans at FVTPL	534,098	-	-	-	-	534,098
Loan at amortized cost	24,443,325	9,901,710	975,680	5,090,928	10,093,297	50,504,940
Securities at FVTPL	5,417,837	15,557	577,157	233	553,519	6,564,303
Derivative assets	863,223	526	10,440	1,429	33,576	909,194
Securities at FVOCI	4,264,191	162,023	240,705	397,010	998,246	6,062,175
Securities at amortized cost	1,306,357	241,232	69,282	80,133	1,812,470	3,509,474
Other financial assets	4,347,761	242,919	324,886	173,906	927,110	6,016,582
	₩ 46,169,675	12,442,253	2,677,794	6,444,017	18,048,471	85,782,210
Liabilities:						
Deposits	₩ 20,060,092	10,642,720	1,376,168	4,820,793	9,766,248	46,666,021
Financial liabilities at FVTPL	7,114	-	-	-	581,458	588,572
Derivative liabilities	496,616	418	12,042	1,712	13,642	524,430
Borrowings	7,518,545	940,877	181,027	463,098	931,802	10,035,349
Debt securities issued	8,887,807	137,022	892,220	-	982,736	10,899,785
Financial liabilities designated at FVTPL	1,553,683	-	-	-	-	1,553,683
Other financial liabilities	3,806,778	116,544	195,387	551,976	1,112,455	5,783,140
	₩ 42,330,635	11,837,581	2,656,844	5,837,579	13,388,341	76,050,980
Net domestic and foreign currency exposure	₩ 3,839,040	604,672	20,950	606,438	4,660,130	9,731,230
Off-balance derivative exposure	(419,387)	(62,614)	325,000	(95,526)	(2,113,543)	(2,366,070)
Net foreign currency exposure	₩ 3,419,653	542,058	345,950	510,912	2,546,587	7,365,160

SHINHAN FINANCIAL GROUP CO., LTD. AND SUBSIDIARIES

Notes to the Consolidated Financial Statements

December 31, 2021 and 2020

(In millions of won)

4. Financial risk management (continued)

(c) Market risk (continued)

iii) Foreign exchange risk (continued)

Foreign currency denominated assets and liabilities as of December 31, 2021 and 2020 are as follows (continued):

	December 31, 2020					
	USD	JPY	EUR	CNY	Other	Total
Assets:						
Cash and due from banks at amortized cost	₩ 4,729,453	1,988,215	402,137	798,053	3,053,388	10,971,246
Due from banks at FVTPL	31,633	-	-	-	-	31,633
Loans at FVTPL	745,277	19,807	91,503	-	-	856,587
Loan at amortized cost	21,435,678	9,076,702	1,296,284	4,130,855	8,987,453	44,926,972
Securities at FVTPL	4,426,257	2,574	455,769	-	316,468	5,201,068
Derivative assets	913,778	21,531	50,842	1,100	114,055	1,101,306
Securities at FVOCI	3,868,880	149,718	222,547	460,681	1,000,855	5,702,681
Securities at amortized cost	1,273,204	240,619	69,132	45,151	1,588,358	3,216,464
Other financial assets	2,180,140	284,695	177,538	336,325	559,805	3,538,503
	₩ 39,604,300	11,783,861	2,765,752	5,772,165	15,620,382	75,546,460
Liabilities:						
Deposits	₩ 17,542,371	10,136,700	991,501	4,650,406	8,438,144	41,759,122
Financial liabilities at FVTPL	-	-	-	-	544,916	544,916
Derivative liabilities	558,064	10,819	33,940	858	105,134	708,815
Borrowings	8,431,144	810,819	306,829	163,454	692,305	10,404,551
Debt securities issued	8,417,214	87,504	933,570	-	1,652,835	11,091,123
Financial liabilities designated at FVTPL	1,068,245	-	-	-	-	1,068,245
Other financial liabilities	3,479,117	123,510	250,428	564,623	843,635	5,261,313
	₩ 39,496,155	11,169,352	2,516,268	5,379,341	12,276,969	70,838,085
Net domestic and foreign currency exposure	₩ 108,145	614,509	249,484	392,824	3,343,413	4,708,375
Off-balance derivative exposure	438,469	(166,923)	187,408	44,764	(896,933)	(393,215)
Net foreign currency exposure	₩ 546,614	447,586	436,892	437,588	2,446,480	4,315,160

SHINHAN FINANCIAL GROUP CO., LTD. AND SUBSIDIARIES

Notes to the Consolidated Financial Statements

December 31, 2021 and 2020

(In millions of won)

4. Financial risk management (continued)

(d) Liquidity risk

Liquidity risk refers to the risk of unexpected losses (such as the disposal of assets abnormal pricing, the procurement of high interest rates, etc.) or insolvency due to inconsistency in funding periods between assets and liabilities or a sudden outflow of funds.

Each subsidiary seeks to minimize liquidity risk through early detection of risk factors related to the sourcing and managing of funding that may cause volatility in liquidity and by ensuring that it maintains an appropriate level of liquidity through systematic management. At the Group level, the Group manages liquidity risk by conducting monthly stress tests that compare liquidity requirements under normal situations against those under three types of stress situations, namely, the group-specific internal crisis, crisis in the external market and a combination of internal and external crisis. Therefore, the Group is checking the liquidity side for abnormalities in preparation for the usual crisis.

In addition, in order to pre-emptively and comprehensively manage liquidity risk, the Group measures and monitors liquidity risk management using various indices, including the 'limit management index', 'early warning index' and 'monitoring index'.

Shinhan Bank applies the following basic principles for liquidity risk management:

- Raise funding in sufficient amounts, at the optimal time at reasonable costs;
- Maintain risk at appropriate levels and preemptively manage them through a prescribed risk limit system and an early warning signal detection system;
- Secure stable sources of revenue and minimize actual losses by implementing an effective asset-liability management system based on diversified sources of funding with varying maturities;
- Monitor and manage daily and intra-daily liquidity positions and risk exposures for timely payment and settlement of financial obligations due under both normal and crisis situations;
- Conduct periodic contingency analysis in anticipation of any potential liquidity crisis and establish and implement emergency plans in case of a crisis actually happening; and
- Consider liquidity-related costs, benefits of and risks in determining the pricing of the Group's products and services, employee performance evaluations and approval of launching of new products and services.

Shinhan Card sets and operates a level that can withstand a 3-month credit crunch for end-of-month liquidity. The Group defines and manages the level of caution, anxiety and risk for the real-life liquidity gap ratio, liquidity buffer ratio, and ABS weight compared to borrowings which are major indicators related to liquidity risk. A contingency plan has been established to prepare for a crisis.

SHINHAN FINANCIAL GROUP CO., LTD. AND SUBSIDIARIES

Notes to the Consolidated Financial Statements

December 31, 2021 and 2020

(In millions of won)

4. Financial risk management (continued)

(d) Liquidity risk (continued)

The details of the composition of non-derivative financial instruments and derivative financial instruments by remaining period are as of December 31, 2021 and 2020 are as follows:

		December 31, 2021						
		Less than 1 month	1~3 months	3~6 months	6 months ~ 1 year	1~5 years	More than 5 years	Total
Non-derivative financial instruments:								
Assets:								
Cash and due from banks at amortized cost	₩	24,864,116	796,046	329,809	1,151,073	108,491	1,299,438	28,548,973
Due from banks at fair value through profit or loss		34,263	-	-	-	-	-	34,263
Loans at fair value through profit or loss		170,540	628,905	117,975	49,932	563,246	167,284	1,697,882
Loans at amortized cost		32,258,357	45,442,330	57,821,874	89,630,955	129,534,255	75,571,202	430,258,973
Securities at fair value through profit or loss		51,899,638	106,637	385,952	608,957	2,024,069	5,776,840	60,802,093
Securities at fair value through other comprehensive income		60,818,846	1,204,770	91,704	634,600	1,249,183	897,270	64,896,373
Securities at amortized cost		515,883	2,542,470	1,992,334	4,273,021	18,358,433	36,658,577	64,340,718
Other financial assets		21,052,012	50,602	25,096	372,536	253,373	1,800,309	23,553,928
	₩	<u>191,613,655</u>	<u>50,771,760</u>	<u>60,764,744</u>	<u>96,721,074</u>	<u>152,091,050</u>	<u>122,170,920</u>	<u>674,133,203</u>
Liabilities:								
Deposits(*2)	₩	212,378,477	36,147,003	40,879,482	59,303,450	17,046,796	2,589,696	368,344,904
Financial liabilities at fair value through profit or loss		1,371,503	-	-	-	-	-	1,371,503
Borrowings		13,159,909	3,928,317	3,643,545	5,171,542	14,168,441	3,649,507	43,721,261
Debt securities issued		4,833,061	7,033,973	7,257,291	17,537,101	41,799,782	5,334,848	83,796,056
Financial liabilities designated at fair value through profit or loss		332,597	294,931	586,682	1,298,402	4,165,201	1,346,057	8,023,870
Other financial liabilities		26,754,163	175,952	136,110	568,997	579,871	159,352	28,374,445
	₩	<u>258,829,710</u>	<u>47,580,176</u>	<u>52,503,110</u>	<u>83,879,492</u>	<u>77,760,091</u>	<u>13,079,460</u>	<u>533,632,039</u>
Off balance(*3):								
Guarantee contracts(*4)	₩	5,399,286	-	-	-	-	-	5,399,286
Other liabilities related to loan commitments		193,853,866	-	-	-	-	-	193,853,866
	₩	<u>199,253,152</u>	<u>-</u>	<u>-</u>	<u>-</u>	<u>-</u>	<u>-</u>	<u>199,253,152</u>
Derivatives	₩	380,609	23,508	11,867	23,099	(363,034)	47,464	123,513

SHINHAN FINANCIAL GROUP CO., LTD. AND SUBSIDIARIES

Notes to the Consolidated Financial Statements

December 31, 2021 and 2020

(In millions of won)

4. Financial risk management (continued)

(d) Liquidity risk (continued)

The details of the composition of non-derivative financial instruments and derivative financial instruments by remaining period are as of December 31, 2021 and 2020 are as follows (continued):

		December 31, 2020						
		Less than 1 month	1~3 months	3~6 months	6 months ~ 1 year	1~5 years	More than 5 years	Total
Non-derivative financial instruments:								
Assets:								
Cash and due from banks at amortized cost	₩	30,486,441	845,977	501,733	860,975	4,467	516,661	33,216,254
Due from banks at fair value through profit or loss		63,113	-	-	-	-	-	63,113
Loans at fair value through profit or loss		31,100	689,261	46,369	117,820	310,954	880,595	2,076,099
Loans at amortized cost		30,170,280	38,040,760	52,331,623	82,840,301	119,243,663	69,258,709	391,885,336
Securities at fair value through profit or loss		44,779,587	1,413,545	571,552	1,160,406	3,384,948	4,729,943	56,039,981
Securities at fair value through other comprehensive income		55,002,284	10,740	207	414	79,640	3,321,488	58,414,773
Securities at amortized cost		385,809	2,070,392	1,202,211	3,649,376	19,054,766	34,889,104	61,251,658
Other financial assets		15,451,455	102,714	138,116	287,473	231,608	1,571,561	17,782,927
	₩	<u>176,370,069</u>	<u>43,173,389</u>	<u>54,791,811</u>	<u>88,916,765</u>	<u>142,310,046</u>	<u>115,168,061</u>	<u>620,730,141</u>
Liabilities:								
Deposits(*2)	₩	187,299,944	28,357,521	36,578,825	59,863,780	14,894,480	2,355,459	329,350,009
Financial liabilities at fair value through profit or loss		1,409,608	794	7,042	2,785	18,870	-	1,439,099
Borrowings		14,670,192	3,783,621	2,920,338	5,463,070	10,692,374	4,392,815	41,922,410
Debt securities issued		5,872,508	6,261,775	5,039,503	11,457,246	43,712,609	6,454,265	78,797,906
Financial liabilities designated at fair value through profit or loss		596,675	221,857	336,784	1,277,802	5,043,549	979,057	8,455,724
Other financial liabilities		29,128,836	97,138	151,655	542,221	643,043	75,813	30,638,706
	₩	<u>238,977,763</u>	<u>38,722,706</u>	<u>45,034,147</u>	<u>78,606,904</u>	<u>75,004,925</u>	<u>14,257,409</u>	<u>490,603,854</u>
Off balance(*3):								
Guarantee contracts(*4)	₩	4,481,506	-	-	-	-	-	4,481,506
Other liabilities related to loan commitments		187,536,416	-	-	19,900	-	-	187,556,316
	₩	<u>192,017,922</u>	<u>-</u>	<u>-</u>	<u>19,900</u>	<u>-</u>	<u>-</u>	<u>192,037,822</u>
Derivatives	₩	419,951	29,829	75,483	149,274	103,770	101,072	879,379

SHINHAN FINANCIAL GROUP CO., LTD. AND SUBSIDIARIES

Notes to the Consolidated Financial Statements

December 31, 2021 and 2020

(In millions of won)

4. Financial risk management (continued)

(d) Liquidity risk (continued)

(*1) These amounts include cash flows of principal and interest on financial assets and financial liabilities.

(*2) Demand deposits amounting to ₩172,107,724 million and ₩148,725,197 million as of December 31, 2021 and 2020 are included in the 'Less than 1 month' category, respectively.

(*3) Though guarantees, loan agreements, and other credit offerings corresponding to financial guarantees such as bond issuance and loan collateral provided by the Group exist, if the counterparty requests a payment, the Group should fulfill the obligation immediately.

(*4) The amount is a financial guarantee, and the non-financial guarantee is ₩ 11,346,421 million and ₩ 10,799,393 million as of December 31, 2021 and 2020.

(e) Measurement of fair value

The fair values of financial instruments being traded in an active market are determined by the published market prices of each period end. The published market prices of financial instruments being held by the Group are based on the trading agencies' notifications. If the market for a financial instrument is not active, such as OTC (Over The Counter market) derivatives, fair value is determined either by using a valuation technique or independent third-party valuation service.

The Group uses its judgment to select a variety of methods and make rational assumptions that are mainly based on market conditions existing at the end of each reporting period. The fair value of financial instruments is determined using valuation techniques; a method of using recent transactions between independent parties with reasonable judgment and willingness to trade, a method of referring to the current fair value of other financial instruments that are substantially identical, discounted cash flow model and option pricing models. For example, the fair value of an interest rate swap is calculated as the present value of the expected future cash flows, and the fair value of foreign exchange forwarding contract is calculated by applying the public forward exchange rate at the end of the reporting period.

The Group classifies and discloses fair value of financial instruments into the following three-level hierarchy:

- Level 1: Financial instruments measured at quoted prices from active markets are classified as fair value level 1.
- Level 2: Financial instruments measured using valuation techniques where all significant inputs are observable market data are classified as level 2.
- Level 3: Financial instruments measured using valuation techniques where one or more significant inputs are not based on observable market data are classified as level 3.

SHINHAN FINANCIAL GROUP CO., LTD. AND SUBSIDIARIES

Notes to the Consolidated Financial Statements

December 31, 2021 and 2020

(In millions of won)

4. Financial risk management (continued)

(e) Measurement of fair value (continued)

i) Financial instruments measured at fair value

i-1) The fair value hierarchy of financial instruments presented at their fair values in the statements of financial position as of December 31, 2021 and 2020 are as follows:

		December 31, 2021			
		Level 1	Level 2	Level 3(*3)	Total
Financial assets					
Due from banks measured at FVTPL	₩	-	-	34,262	34,262
Loans at FVTPL(*1)		-	790,510	892,834	1,683,344
Securities at FVTPL:					
Debt securities and other securities(*2)		7,250,389	40,396,692	10,580,066	58,227,147
Equity securities		942,433	107,416	1,325,466	2,375,315
Gold/silver deposits		83,691	-	-	83,691
		<u>8,276,513</u>	<u>40,504,108</u>	<u>11,905,532</u>	<u>60,686,153</u>
Derivative assets:					
Trading		11,542	3,033,965	528,619	3,574,126
Hedging		-	225,063	-	225,063
		<u>11,542</u>	<u>3,259,028</u>	<u>528,619</u>	<u>3,799,189</u>
Securities measured at FVOCI:					
Debt securities		24,951,761	38,855,158	-	63,806,919
Equity securities		257,947	48,225	725,232	1,031,404
		<u>25,209,708</u>	<u>38,903,383</u>	<u>725,232</u>	<u>64,838,323</u>
	₩	<u>33,497,763</u>	<u>83,457,029</u>	<u>14,086,479</u>	<u>131,041,271</u>
Financial liabilities:					
Financial liabilities measured at FVTPL:					
Securities sold	₩	787,767	-	-	787,767
Gold/silver deposits		581,458	-	-	581,458
		<u>1,369,225</u>	<u>-</u>	<u>-</u>	<u>1,369,225</u>
Financial liabilities designated at fair value through profit or loss:					
Derivatives-combined securities(*2)		-	401,345	7,622,525	8,023,870
Derivative liabilities:					
Trading		191,061	2,862,761	153,933	3,207,755
Hedging		-	196,060	182,749	378,809
		<u>191,061</u>	<u>3,058,821</u>	<u>336,682</u>	<u>3,586,564</u>
	₩	<u>1,560,286</u>	<u>3,460,166</u>	<u>7,959,207</u>	<u>12,979,659</u>

(*1) Of the Financial assets at FVTPL invested by the Group, P-note's valuation of amount related to Lime Asset Management is ₩ 157.9 billion. As of December 31, 2021, in this regard, international disputes are under way, the Group has estimated its fair value based on financial information within the recent audit report of underlying assets since it doesn't have fair market value observable through active trading markets. Accounting estimates and assumptions used in preparing consolidated financial statements may lead to adjustment in response to changes in uncertainty, such as information and market conditions available in the future. In addition, the ultimate impact on the business, financial condition, performance, and liquidity of the Group is unpredictable.

(*2) Financial instruments (Beneficiary certificates: ₩ 300.2 billion and derivatives-combined securities: ₩ 300.2 billion) related to GEN2 Partners asset management were delayed in repurchase for the year ended December 31, 2021. The Group estimated fair value using the net asset value based on the most recent data available for the repurchase suspension fund. Since then, it has an uncertainty in measuring fair value due to market conditions.

(*3) The valuation amount for the over-the-counter derivatives classified as Level 3 by Shinhan Investment Corp. are ₩72,980 million in financial assets at FVTPL, ₩7,622,526 million in financial liabilities designated at fair value through profit or loss, ₩527,726 million in derivative assets, and ₩153,084 million in derivative liabilities. The above level 3 over-the-counter derivatives measure fair value using the internal valuation model of Shinhan Investment Corp.

SHINHAN FINANCIAL GROUP CO., LTD. AND SUBSIDIARIES

Notes to the Consolidated Financial Statements

December 31, 2021 and 2020

(In millions of won)

4. Financial risk management (continued)

(e) Measurement of fair value (continued)

i) Financial instruments measured at fair value (continued)

i-1) The fair value hierarchy of financial instruments presented at their fair values in the statements of financial position as of December 31, 2021 and 2020 are as follows (continued):

		December 31, 2020			
		Level 1	Level 2	Level 3(*3)	Total
Financial assets					
Due from banks measured at FVTPL	₩	-	-	63,112	63,112
Loans at FVTPL(*1)		-	708,111	1,308,690	2,016,801
Securities at FVTPL:					
Debt securities and other securities(*2)		7,029,453	39,335,739	8,721,500	55,086,692
Equity securities		693,816	210,230	832,413	1,736,459
Gold/silver deposits		188,339	-	-	188,339
		<u>7,911,608</u>	<u>39,545,969</u>	<u>9,553,913</u>	<u>57,011,490</u>
Derivative assets:					
Trading		125,339	4,623,218	408,855	5,157,412
Hedging		-	475,708	795	476,503
		<u>125,339</u>	<u>5,098,926</u>	<u>409,650</u>	<u>5,633,915</u>
Securities measured at FVOCI:					
Debt securities		17,515,390	39,861,238	32,805	57,409,433
Equity securities		172,403	49,673	684,603	906,679
		<u>17,687,793</u>	<u>39,910,911</u>	<u>717,408</u>	<u>58,316,112</u>
	₩	<u>25,724,740</u>	<u>85,263,917</u>	<u>12,052,773</u>	<u>123,041,430</u>
Financial liabilities:					
Financial liabilities measured at FVTPL:					
Securities sold	₩	897,129	-	-	897,129
Gold/silver deposits		539,565	-	-	539,565
		<u>1,436,694</u>	<u>-</u>	<u>-</u>	<u>1,436,694</u>
Financial liabilities designated at fair value through profit or loss:					
Derivatives-combined securities(*2)		-	314,220	8,141,504	8,455,724
Derivative liabilities:					
Trading		161,628	4,431,080	87,356	4,680,064
Hedging		-	233,684	102,819	336,503
		<u>161,628</u>	<u>4,664,764</u>	<u>190,175</u>	<u>5,016,567</u>
	₩	<u>1,598,322</u>	<u>4,978,984</u>	<u>8,331,679</u>	<u>14,908,985</u>

(*1) Of the Financial assets at FVTPL invested by the Group, P-note's valuation of amount related to Lime Asset Management is ₩ 161.2 billion. As of December 31, 2020, in this regard, international disputes are under way, the Group has estimated its fair value based on financial information within the recent audit report of underlying assets since it doesn't have fair market value observable through active trading markets. Accounting estimates and assumptions used in preparing consolidated financial statements may lead to adjustment in response to changes in uncertainty, such as information and market conditions available in the future. In addition, the ultimate impact on the business, financial condition, performance, and liquidity of the Group is unpredictable.

(*2) Financial instruments (Beneficiary certificates: ₩ 211.7 billion and derivatives-combined securities: ₩ 211.7 billion) related to GEN2 Partners asset management were delayed in repurchase for the year ended December 31, 2020. The Group estimated fair value using the net asset value based on the most recent data available for the repurchase suspension fund. Since then, it has an uncertainty in measuring fair value due to market conditions.

(*3) The valuation amount for the over-the-counter derivatives classified as Level 3 by Shinhan Investment Corp. are ₩204,608 million in financial assets at FVTPL, ₩8,141,504 million in financial liabilities designated at fair value through profit or loss, ₩405,313 million in derivative assets, and ₩83,269 million in derivative liabilities. The above level 3 over-the-counter derivatives measure fair value using the internal valuation model of Shinhan Investment Corp.

SHINHAN FINANCIAL GROUP CO., LTD. AND SUBSIDIARIES

Notes to the Consolidated Financial Statements

December 31, 2021 and 2020

(In millions of won)

4. Financial risk management (continued)

(e) Measurement of fair value (continued)

i) Financial instruments measured at fair value

i-2) Classification of financial instruments as fair value level 3

The Group uses the evaluation value from evaluators who are qualified and external independent to determine the fair value for Group's assets at the end of each reporting period. Changes in carrying values of financial instruments classified as Level 3 for the years ended December 31, 2021 and 2020 are as follows:

	December 31, 2021					
	Financial asset at fair value		Securities at fair value through other comprehensive profit or loss	Financial liabilities designated at fair value through profit or loss	Derivative assets and liabilities, net	
	through profit or loss				Held for trading	Held for hedging
Beginning balance	₩	10,925,715	717,408	(8,141,504)	321,499	(102,024)
Recognized in total comprehensive income for the year:						
Recognized in profit (loss) for the year(*1)		271,065	448	(273,536)	348,046	(80,725)
Recognized in other comprehensive income (loss) for the year		38,566	24,672	(1,526)	-	-
		309,631	25,120	(275,062)	348,046	(80,725)
Purchase		4,792,810	21,440	-	4,394	-
Issue		-	-	(8,488,977)	-	-
Settlement		(3,498,968)	(38,736)	9,283,018	(299,633)	-
Reclassification(*3)		(9,641)	-	-	-	-
Transfer to level3(*2)		507,984	-	-	446	-
Transfer from level3(*2)		(194,903)	-	-	(66)	-
Ending balance	₩	12,832,628	725,232	(7,622,525)	374,686	(182,749)

SHINHAN FINANCIAL GROUP CO., LTD. AND SUBSIDIARIES

Notes to the Consolidated Financial Statements

December 31, 2021 and 2020

(In millions of won)

4. Financial risk management (continued)

(e) Measurement of fair value (continued)

i) Financial instruments measured at fair value(continued)

i-2) Classification of financial instruments as fair value level 3(continued)

The Group uses the evaluation value from evaluators who are qualified and external independent to determine the fair value for Group's assets at the end of each reporting period. Changes in carrying values of financial instruments classified as Level 3 for the years ended December 31, 2021 and 2020 are as follows: (continued):

	December 31, 2020							
	Financial asset at fair value		Securities at fair value through other comprehensive profit or loss		Financial liabilities designated at fair value through profit or loss		Derivative assets and liabilities, net	
	through profit or loss	or loss	profit or loss	or loss	or loss	Held for trading	Held for hedging	
Beginning balance	₩	11,762,259		660,118		(8,511,489)	342,830	(186,974)
Recognized in total comprehensive income for the year:								
Recognized in profit (loss) for the year(*1)		(59,931)		(2,094)		(196,743)	51,436	84,950
Recognized in other comprehensive income (loss) for the year		69,819		(2,521)		(9,689)	-	-
		9,888		(4,615)		(206,432)	51,436	84,950
Purchase		4,461,802		61,919		-	1,171	-
Issue		-		-		(9,043,503)	-	-
Settlement		(5,231,666)		(14)		9,928,472	(74,584)	-
Reclassification(*3)		(377,641)		-		-	-	-
Transfer to level3(*2)		358,123		-		(308,552)	625	-
Transfer from level3(*2)		(57,513)		-		-	21	-
Business combination (Note 47)		463		-		-	-	-
Ending balance	₩	10,925,715		717,408		(8,141,504)	321,499	(102,024)

(*1) Recognized profit or loss of the changes in carrying value of financial instruments classified as Level 3 for the years ended December 31, 2021 and 2020 are included in the accounts of the statements of comprehensive income, of which the amounts and the related accounts are as follows:

	December 31, 2021	
	Amounts recognized in profit or loss	Recognized profit or loss from the financial instruments held as of December 31
Net gain on financial assets at fair value through profit or loss	₩	619,111
Net gain (loss) on financial liabilities designated at fair value through profit or loss		(273,536)
Net gain on securities at fair value through other comprehensive income		448
Net other operating expense		(80,725)
	₩	265,298

SHINHAN FINANCIAL GROUP CO., LTD. AND SUBSIDIARIES

Notes to the Consolidated Financial Statements

December 31, 2021 and 2020

(In millions of won)

4. Financial risk management (continued)

(e) Measurement of fair value (continued)

i) Financial instruments measured at fair value(continued)

i-2) Changes in carrying values of financial instruments classified as Level 3 for the years ended December 31, 2021 and 2020 are as follows (continued):

	December 31, 2020	
	Amounts recognized in profit or loss	Recognized profit or loss from the financial instruments held as of December 31
Net loss on financial assets at fair value through profit or loss	₩ (8,495)	(179,989)
Net gain (loss) on financial liabilities designated at fair value through profit or loss	(196,743)	189,885
Net loss on securities at fair value through other comprehensive income	(2,094)	(2,094)
Net other operating income	84,950	19,065
	₩ <u>(122,382)</u>	<u>26,867</u>

(*2) The investment securities transferred to Level 3 as the availability of observable market data changed due to reasons such as suspension of trading, and the derivative instruments transferred to Level 3 as the availability of observable market data changed due to reasons such as changes in the valuation.

(*3) It has been replaced by investment assets in associates.

SHINHAN FINANCIAL GROUP CO., LTD. AND SUBSIDIARIES

Notes to the Consolidated Financial Statements

December 31, 2021 and 2020

(In millions of won)

4. Financial risk management (continued)

(e) Measurement of fair value (continued)

i) Financial instruments measured at fair value (continued)

i-3) Valuation techniques and significant inputs not observable in markets

i-3-1) Valuation techniques and inputs used in measuring the fair value of financial instruments classified as level 2 as of December 31, 2021 and 2020 are as follows:

Type of financial instrument	Valuation technique	December 31, 2021		Significant inputs
		Carrying value		
Assets				
Financial asset at fair value through profit or loss				
Debt securities	DCF	₩	41,187,202	Discount rate, interest rate, stock price, and etc.
Equity securities	NAV		107,416	
			<u>41,294,618</u>	Price of underlying assets such as stocks, bonds, etc.
Derivative assets				
Trading	Option model,		3,033,965	Discount rate, foreign exchange rate, volatility, stock price, and commodity index, etc.
Hedging	Implied forward interest rate, DCF		225,063	
			<u>3,259,028</u>	
Securities at fair value through other comprehensive income				
Debt securities	DCF		38,855,158	Interest rate, discount rate and price of underlying assets such as stock, bonds, etc.
Equity securities	NAV		48,225	
			<u>38,903,383</u>	
		₩	<u>83,457,029</u>	
Liabilities				
Financial liabilities designated at fair value through profit or loss				
Compound financial instruments	Black-Scholes model	₩	401,345	Discount rate
Derivative liabilities				
Trading	Option model,		2,862,761	Discount rate, foreign exchange rate, volatility, stock price, and commodity index, etc.
Hedging	DCF		196,060	
			<u>3,058,821</u>	
		₩	<u>3,460,166</u>	

SHINHAN FINANCIAL GROUP CO., LTD. AND SUBSIDIARIES

Notes to the Consolidated Financial Statements

December 31, 2021 and 2020

(In millions of won)

4. Financial risk management (continued)

(e) Measurement of fair value (continued)

i) Financial instruments measured at fair value (continued)

i-3) Valuation techniques and significant inputs not observable in markets (continued)

i-3-1) Valuation techniques and inputs used in measuring the fair value of financial instruments classified as level 2 as of December 31, 2021 and 2020 are as follows (continued):

Type of financial instrument	Valuation technique	December 31, 2020	
		Carrying value	Significant inputs
Assets			
Financial asset at fair value through profit or loss			
Debt securities	DCF	₩ 40,043,850	Discount rate, interest rate, stock price, and etc.
Equity securities	NAV	210,230	Price of underlying assets such as stocks, bonds
		<u>40,254,080</u>	
Derivative assets			
Trading		4,623,218	
Hedging	Option model, DCF	475,708	Discount rate, foreign exchange rate, volatility, stock price, and commodity index, etc.
		<u>5,098,926</u>	
Securities at fair value through other comprehensive income			
Debt securities	DCF	39,861,238	Discount rate, interest rate and price of underlying assets such as stock, bonds
Equity securities	NAV	49,673	
		<u>39,910,911</u>	
		₩ <u>85,263,917</u>	
Liabilities			
Financial liabilities designated at fair value through profit or loss			
Compound financial instruments	DCF	₩ 314,220	Discount rate
Derivative liabilities			
Trading		4,431,080	
Hedging	Option model, DCF	233,684	Discount rate, foreign exchange rate, volatility, stock price, and commodity index, etc.
		<u>4,664,764</u>	
		₩ <u>4,978,984</u>	

SHINHAN FINANCIAL GROUP CO., LTD. AND SUBSIDIARIES

Notes to the Consolidated Financial Statements

December 31, 2021 and 2020

(In millions of won)

4. Financial risk management (continued)

(e) Measurement of fair value (continued)

i) Financial instruments measured at fair value (continued)

i-3) Valuation techniques and significant inputs not observable in markets (continued)

i-3-2) Valuation techniques and significant inputs, but not observable, used in measuring the fair value of financial instruments classified as level 3 as of December 31, 2021 and 2020 are as follows:

Type of financial instrument	Valuation technique	Carrying value(*2)	December 31, 2021	
			Significant unobservable inputs	Range
Financial assets				
Financial asset at fair value through profit or loss				
Debt securities	DCF, NAV, Option model(*1), Comparable company analysis	₩ 11,507,162	The volatility of the underlying asset, Discount rate, Correlations, and Growth rate	19.48%~72.69% 0.07%~27.30% 23.17%~58.47% 0.00%~1.00%
Equity securities	DCF, NAV, Option model(*1), Comparable company analysis	1,325,466	The volatility of the underlying asset, Discount rate, Correlations, and Growth rate	16.00%~32.00% 5.45%~16.35% 00.00%~54.00% 1.00%
		<u>12,832,628</u>		
Derivative assets				
Equity and foreign exchange related	Option model(*1)	28,783	The volatility of the underlying asset, and Correlations	2.29%~50.00% -5.00%~91.00%
Interest rates related	Option model(*1)	6,029	The volatility of the underlying asset, Correlations, and Discount rate	0.70% 80.00%~82.00% 1.11%~1.83%
Credit and commodity related	Option model(*1)	493,807	The volatility of the underlying asset, and Hazard Rate	0.70%~4.70% 5.17%~93.69%
		<u>528,619</u>		
Securities at fair value through other comprehensive income				
Equity securities	DCF, NAV, Option model(*1), Comparable company analysis	725,232	The volatility of the underlying asset, Discount rate, and Growth rate	25.49% 9.80%~22.79% 0.00%~2.00%
		<u>725,232</u>		
		<u>₩ 14,086,479</u>		

SHINHAN FINANCIAL GROUP CO., LTD. AND SUBSIDIARIES

Notes to the Consolidated Financial Statements

December 31, 2021 and 2020

(In millions of won)

4. Financial risk management (continued)

(e) Measurement of fair value (continued)

i) Financial instruments measured at fair value (continued)

i-3) Valuation techniques and significant inputs not observable in markets (continued)

i-3-2) Valuation techniques and significant inputs, but not observable, used in measuring the fair value of financial instruments classified as level 3 as of December 31, 2021 and 2020 are as follows (continued):

Type of financial instrument	Valuation technique	Carrying value(*2)	December 31, 2021	
			Significant unobservable inputs	Range
Financial liabilities				
Financial liabilities at fair value through profit or loss				
Equity related	Option model(*1)	₩ 7,622,525	The volatility of the underlying asset, and Correlations	0.50%~94.90% -12.00%~88.00%
Derivative liabilities				
Equity and foreign exchange related	Option model(*1)	13,214	The volatility of the underlying asset, and Correlations	2.29%~42.00% -5.00%~91.00%
Interest rates related	Option model(*1)	258,364	The volatility of the underlying asset, Regression coefficient, and Correlations	0.46%~0.78% 0.00%~0.54% 0.00%~90.34%
Credit and commodity related	Option model(*1)	65,104	The volatility of the underlying asset, and Hazard Rate	1.90%~94.90% 5.17%~100.79%
		<u>336,682</u>		
		<u>₩ 7,959,207</u>		

(*1) Option model that the Group uses in derivative valuation includes Black-Scholes model, Hull-White model, Monte Carlo simulation, etc.

(*2) There is no disclosure for valuation techniques and input variables related to items where the carrying value is recognized as a reasonable approximation of fair value and the carrying value is disclosed at fair value.

SHINHAN FINANCIAL GROUP CO., LTD. AND SUBSIDIARIES

Notes to the Consolidated Financial Statements

December 31, 2021 and 2020

(In millions of won)

4. Financial risk management (continued)

(e) Measurement of fair value (continued)

i) Financial instruments measured at fair value (continued)

i-3) Valuation techniques and significant inputs not observable in markets (continued)

i-3-2) Valuation techniques and significant inputs, but not observable, used in measuring the fair value of financial instruments classified as level 3 as of December 31, 2021 and 2020 are as follows (continued):

Type of financial instrument	Valuation technique	Carrying value(*2)	December 31, 2020	
			Significant unobservable inputs	Range
Financial assets				
Financial asset at fair value through profit or loss				
Debt securities	DCF, Option model(*1), Comparable company analysis	₩ 10,093,302	The volatility of the underlying asset, Discount rate, and Correlations	5.06%~61.32% 0.35%~27.17% 0.00%~100.0%
Equity securities	DCF, NAV, Option model(*1), Comparable company analysis	832,413	The volatility of the underlying asset, Discount rate, and Correlations	21.00%~40.00% 5.83%~16.87% 20.00%~79.00%
		10,925,715		
Derivative assets				
Equity and foreign exchange related	Option model(*1)	113,496	The volatility of the underlying asset, and Correlations	4.30%~127.00% -3.00%~82.00%
Interest rates related	Option model(*1)	23,112	The volatility of the underlying asset, Regression coefficient, and Correlations	0.47%~1.00% 0.30%~0.58% 26.00%~90.45%
Credit and commodity related	Option model(*1)	273,042	The volatility of the underlying asset, and Correlations	1.00%~40.00% -43.00%~92.00%
		409,650		
Securities at fair value through other comprehensive income				
Debt securities	DCF, NAV, Option model(*1), Comparable company analysis	32,805	The volatility of the underlying asset, Discount rate, and Growth rate	22.11%
Equity securities		684,603		0.05%~19.05% 0.00%~2.00%
		717,408		
		₩ 12,052,773		

SHINHAN FINANCIAL GROUP CO., LTD. AND SUBSIDIARIES

Notes to the Consolidated Financial Statements

December 31, 2021 and 2020

(In millions of won)

4. Financial risk management (continued)

(e) Measurement of fair value (continued)

i) Financial instruments measured at fair value (continued)

i-3) Valuation techniques and significant inputs not observable in markets (continued)

i-3-2) Valuation techniques and significant inputs, but not observable, used in measuring the fair value of financial instruments classified as level 3 as of December 31, 2021 and 2020 are as follows (continued):

Type of financial instrument	Valuation technique	Carrying value(*2)	December 31, 2020	
			Significant unobservable inputs	Range
Financial liabilities				
Financial liabilities at fair value through profit or loss				
Equity related	Option model(*1)	₩ 8,141,504	The volatility of the underlying asset, and Correlations	1.00%~127.00% -43.00%~92.00%
Derivative liabilities				
Equity and foreign exchange related	Option model(*1)	25,525	The volatility of the underlying asset, and Correlations	4.30%~61.00% -3.00%~82.00%
Interest rates related	Option model(*1)	134,759	The volatility of the underlying asset, Regression coefficient, and Correlations	0.47%~40.00% 0.30%~0.63% 20.13%~90.34%
Credit and commodity related	Option model(*1)	29,891	The volatility of the underlying asset, and Correlations	1.00%~102.00% -43.00%~92.00%
		190,175		
		<u>₩ 8,331,679</u>		

(*1) Option model that the Group uses in derivative valuation includes Black-Scholes model, Hull-White model, Monte Carlo simulation, etc.

(*2) There is no disclosure for valuation techniques and input variables related to items where the carrying value is recognized as a reasonable approximation of fair value and the carrying value is disclosed at fair value.

SHINHAN FINANCIAL GROUP CO., LTD. AND SUBSIDIARIES

Notes to the Consolidated Financial Statements

December 31, 2021 and 2020

(In millions of won)

4. Financial risk management (continued)

(e) Measurement of fair value (continued)

i) Financial instruments measured at fair value (continued)

i-4) Sensitivity for changing in unobservable inputs

For level 3 fair value measurement, changing one or more of the unobservable inputs used to reasonably possible alternative assumptions would have the following effects on profit or loss, or other comprehensive income as of December 31, 2021 and 2020.

	<u>December 31, 2021</u>	
	<u>Favorable changes</u>	<u>Unfavorable changes</u>
Financial assets:		
Effects on profit or loss for the period(*1),(*2):		
Financial asset at fair value through profit or loss	₩ 39,084	(43,072)
Derivative assets	16,893	(11,809)
Securities at fair value through other comprehensive income(*2)	38,865	(38,210)
	<u>₩ 94,842</u>	<u>(93,091)</u>
Financial liabilities:		
Effects on profit or loss for the period(*1):		
Financial liabilities designated at fair value through profit or loss	₩ 45,493	(50,845)
Derivative liabilities	25,326	(23,486)
	<u>₩ 70,819</u>	<u>(74,331)</u>
	<u>December 31, 2020</u>	
	<u>Favorable changes</u>	<u>Unfavorable changes</u>
Financial assets:		
Effects on profit or loss for the period(*1),(*2):		
Financial asset at fair value through profit or loss	₩ 53,821	(48,547)
Derivative assets	23,011	(21,532)
Securities at fair value through other comprehensive income(*2)	26,817	(21,044)
	<u>₩ 103,649</u>	<u>(91,123)</u>
Financial liabilities:		
Effects on profit or loss for the period(*1):		
Financial liabilities designated at fair value through profit or loss	₩ 72,042	(71,690)
Derivative liabilities	17,976	(18,368)
	<u>₩ 90,018</u>	<u>(90,058)</u>

(*1) Fair value changes are calculated by increasing or decreasing the volatility of the underlying asset, a significant unobservable input.

(-10~10%p) or correlations (-10~10%p).

(*2) Fair value changes are calculated by increasing or decreasing discount rate (-1~1%p) and applying growth rate, a significant unobservable input at 0% ~ 1%.

SHINHAN FINANCIAL GROUP CO., LTD. AND SUBSIDIARIES

Notes to the Consolidated Financial Statements

December 31, 2021 and 2020

(In millions of won)

4. Financial risk management (continued)

(e) Measurement of fair value (continued)

ii) Financial instruments measured at amortized cost

ii-1) The method of measuring the fair value of financial instruments measured at amortized cost is as follows:

Type	Measurement methods of fair value
Cash and due from banks	The carrying value and the fair value for cash are identical and most of deposits are floating interest rate deposits or next day deposits of a short-term instrument. For this reason, the carrying value approximates fair value.
Loans	The fair value of the loans is measured by discounting the expected cash flow at the market interest rate and credit risk of the borrower.
Securities	An external professional evaluation agency is used to calculate the valuation amount using the market information. The agency calculates the fair value based on active market prices, and DCF model is used to calculate the fair value if there is no quoted price.
Deposits and borrowings	The carrying value and the fair value for demand deposits, cash management account deposits, call money as short-term instrument are identical. The fair value of others is measured by discounting the contractual cash flow at the market interest rate that takes into account the residual risk.
Debt securities issued	Where available, the fair value of deposits and borrowings is based on the published price quotations in an active market. In case there is no data for an active market price, it is measured by discounting the contractual cash flow at the market interest rate that takes into account the residual risk.
Other financial assets and other financial liabilities	The carrying value is measured at fair value for short-term and suspense accounts, such as spot exchange, inter-bank fund transfer, and domestic exchange of payments, and for the remaining financial instruments, the present value is calculated by discounting the contractual cash flows at a discount rate which considered residual risk at the market interest rate.

SHINHAN FINANCIAL GROUP CO., LTD. AND SUBSIDIARIES

Notes to the Consolidated Financial Statements

December 31, 2021 and 2020

(In millions of won)

4. Financial risk management (continued)

(e) Measurement of fair value (continued)

ii) Financial instruments measured at amortized cost (continued)

ii-2) The carrying value and the fair value of financial instruments measured at amortized cost as of December 31, 2021 and 2020 are as follows:

	December 31, 2021		December 31, 2020	
	Carrying value	Fair value	Carrying value	Fair value
Assets:				
Deposits measured at amortized cost	₩ 24,232,013	24,216,932	31,605,262	31,607,122
Loans measured at amortized cost				
Retails	159,090,991	159,262,881	146,843,366	147,634,589
Corporations	197,356,011	198,053,452	177,046,416	178,420,230
Public and other funding loans	3,795,225	3,812,717	4,021,926	4,048,167
Loans between banks	3,844,227	3,839,726	5,487,147	5,495,236
Credit card	25,050,702	25,438,046	22,822,664	23,220,987
	<u>389,137,156</u>	<u>390,406,822</u>	<u>356,221,519</u>	<u>358,819,209</u>
Securities measured at amortized cost				
Government bonds	34,679,301	34,377,110	31,816,320	33,391,597
Financial institution bonds	3,423,536	3,477,834	3,835,577	3,987,172
Corporation bonds	11,827,239	11,750,467	11,630,726	12,075,175
	<u>49,930,076</u>	<u>49,605,411</u>	<u>47,282,623</u>	<u>49,453,944</u>
Other financial assets	23,238,932	23,389,209	20,341,191	20,359,778
	<u>₩ 486,538,177</u>	<u>487,618,374</u>	<u>455,450,595</u>	<u>460,240,053</u>
Liabilities:				
Deposit liabilities				
Demand deposits	₩ 172,107,724	172,107,724	148,725,197	148,725,197
Time deposits	161,498,901	161,301,409	157,833,891	157,936,969
Certificate of deposit	16,576,536	16,606,894	5,946,704	5,965,139
Issued bill deposit	5,818,001	5,817,844	6,226,937	6,226,855
CMA deposits	5,246,478	5,246,478	4,006,319	4,006,319
Others	3,649,035	3,648,983	3,677,820	3,678,316
	<u>364,896,675</u>	<u>364,729,332</u>	<u>326,416,868</u>	<u>326,538,795</u>
Borrowing debts:				
Call-money	1,534,611	1,534,611	1,760,042	1,760,042
Bills sold	9,032	9,019	10,706	10,696
Bonds sold under repurchase agreements	10,709,115	10,709,115	11,065,584	11,065,584
Borrowings	30,914,307	30,803,417	28,757,732	28,863,015
	<u>43,167,065</u>	<u>43,056,162</u>	<u>41,594,064</u>	<u>41,699,337</u>
Debts:				
Borrowings in Korean won	69,288,982	69,081,140	64,083,920	64,842,258
Borrowings in foreign currency	10,860,381	11,076,757	11,050,474	11,262,332
	<u>80,149,363</u>	<u>80,157,897</u>	<u>75,134,394</u>	<u>76,104,590</u>
Other financial liabilities	29,880,879	29,872,186	34,129,626	34,136,128
	<u>₩ 518,093,982</u>	<u>517,815,577</u>	<u>477,274,952</u>	<u>478,478,850</u>

SHINHAN FINANCIAL GROUP CO., LTD. AND SUBSIDIARIES

Notes to the Consolidated Financial Statements

December 31, 2021 and 2020

(In millions of won)

4. **Financial risk management (continued)**

(e) **Measurement of fair value (continued)**

ii) *Financial instruments measured at amortized cost (continued)*

ii-3) The fair value hierarchy of financial assets and liabilities which are not measured at their fair values in the statements of financial position but with their fair value disclosed as of December 31, 2021 and 2020 are as follows:

		December 31, 2021			
		Level 1	Level 2	Level 3	Total
Assets:					
Deposits measured at amortized cost	₩	252,474	23,964,458	-	24,216,932
Loans measured at amortized cost					
Retails		-	-	159,262,881	159,262,881
Corporations		-	-	198,053,452	198,053,452
Public and other funding loans		-	-	3,812,717	3,812,717
Loans between banks		-	2,387,533	1,452,193	3,839,726
Credit card		-	-	25,438,046	25,438,046
		-	2,387,533	388,019,289	390,406,822
Securities measured at amortized cost:					
Government bonds		23,045,322	11,331,788	-	34,377,110
Financial institution bonds		698,105	2,779,729	-	3,477,834
Debentures		-	11,662,046	88,421	11,750,467
		23,743,427	25,773,563	88,421	49,605,411
Other financial assets					
		-	14,200,356	9,188,853	23,389,209
	₩	23,995,901	66,325,910	397,296,563	487,618,374
Liabilities:					
Deposit liabilities					
Demand deposits	₩	-	172,107,724	-	172,107,724
Time deposits		-	-	161,301,409	161,301,409
Certificate of deposit		-	-	16,606,894	16,606,894
Issued bill deposit		-	-	5,817,844	5,817,844
CMA deposits		-	5,246,478	-	5,246,478
Other		-	3,553,942	95,041	3,648,983
		-	180,908,144	183,821,188	364,729,332
Borrowing debts:					
Call-money		-	1,534,611	-	1,534,611
Bills sold		-	-	9,019	9,019
Bonds sold under repurchase agreements		-	-	10,709,115	10,709,115
Borrowings		-	-	30,803,417	30,803,417
		-	1,534,611	41,521,551	43,056,162
Debts:					
Borrowings in won		-	38,474,804	30,606,336	69,081,140
Borrowings in foreign currency		-	7,956,414	3,120,343	11,076,757
		-	46,431,218	33,726,679	80,157,897
Other financial liabilities					
		-	9,413,875	20,458,311	29,872,186
	₩	-	238,287,848	279,527,729	517,815,577

SHINHAN FINANCIAL GROUP CO., LTD. AND SUBSIDIARIES

Notes to the Consolidated Financial Statements

December 31, 2021 and 2020

(In millions of won)

4. **Financial risk management (continued)**

(e) **Measurement of fair value (continued)**

ii) *Financial instruments measured at amortized cost (continued)*

ii-3) The fair value hierarchy of financial assets and liabilities which are not measured at their fair values in the statements of financial position but with their fair value disclosed as of December 31, 2021 and 2020 are as follows (continued):

		December 31, 2020			
		Level 1	Level 2	Level 3	Total
Assets:					
Deposits measured at amortized cost	₩	779,759	29,957,444	869,919	31,607,122
Loans measured at amortized cost					
Retails		-	-	147,634,589	147,634,589
Corporations		-	-	178,420,230	178,420,230
Public and other funding loans		-	-	4,048,167	4,048,167
Loans between banks		-	2,187,270	3,307,966	5,495,236
Credit card		-	-	23,220,987	23,220,987
		-	2,187,270	356,631,939	358,819,209
Securities measured at amortized cost:					
Government bonds		22,130,487	11,261,110	-	33,391,597
Financial institution bonds		1,070,220	2,916,952	-	3,987,172
Debentures		-	11,994,724	80,451	12,075,175
		23,200,707	26,172,786	80,451	49,453,944
Other financial assets					
		-	8,661,345	11,698,433	20,359,778
	₩	23,980,466	66,978,845	369,280,742	460,240,053
Liabilities:					
Deposit liabilities					
Demand deposits	₩	-	148,725,197	-	148,725,197
Time deposits		-	-	157,936,969	157,936,969
Certificate of deposit		-	-	5,965,139	5,965,139
Issued bill deposit		-	-	6,226,855	6,226,855
CMA deposits		-	4,006,319	-	4,006,319
Other		-	3,534,696	143,620	3,678,316
		-	156,266,212	170,272,583	326,538,795
Borrowing debts:					
Call-money		-	1,760,042	-	1,760,042
Bills sold		-	-	10,696	10,696
Bonds sold under repurchase agreements		95,400	-	10,970,184	11,065,584
Borrowings		-	8,500	28,854,515	28,863,015
		95,400	1,768,542	39,835,395	41,699,337
Debts:					
Borrowings in won		-	35,740,750	29,101,508	64,842,258
Borrowings in foreign currency		-	7,944,242	3,318,090	11,262,332
		-	43,684,992	32,419,598	76,104,590
Other financial liabilities					
		-	10,383,020	23,753,108	34,136,128
	₩	95,400	212,102,766	266,280,684	478,478,850

SHINHAN FINANCIAL GROUP CO., LTD. AND SUBSIDIARIES

Notes to the Consolidated Financial Statements

December 31, 2021 and 2020

(In millions of won)

4. Financial risk management (continued)

(e) Measurement of fair value (continued)

ii) Financial instruments measured at amortized cost (continued)

ii-4) Valuation techniques and inputs used in the fair value measurements categorized within Level 2 and Level 3 for fair value disclosures, which are not recognized at fair value, as at December 31, 2021 and 2020, are as follows:

				December 31, 2021		
				Fair value(*)	Valuation technique	Inputs
Financial instruments classified as level 2 :						
Assets						
Due from banks measured at amortized cost	₩	23,964,458		DCF		Discount rate
Loans measured at amortized cost		2,387,533		DCF		Discount rate, credit spread, prepayment rate
Securities measured at amortized cost		25,773,563		DCF		Discount rate
Other financial assets		14,200,356		DCF		Discount rate
Financial instruments classified as level 3 :						
Assets						
Loans measured at amortized cost		388,019,289		DCF		Discount rate, credit spread, prepayment rate
Securities measured at amortized cost		88,421		DCF		Discount rate
Other financial assets		9,188,853		DCF		Discount rate
	₩	<u>463,622,473</u>				
Financial instruments classified as level 2 :						
Liabilities						
Deposits	₩	180,908,144		DCF		Discount rate
Borrowings		1,534,611		DCF		Discount rate
Debt securities issued		46,431,218		DCF		Discount rate
Other financial liabilities		9,413,875		DCF		Discount rate
Financial instruments classified as level 3 :						
Liabilities						
Deposits		183,821,188		DCF		Discount rate
Borrowings		41,521,551		DCF		Discount rate
Debt securities issued		33,726,679		DCF		Discount rate, regression coefficient, correlation coefficient
Other financial liabilities		20,458,311		DCF		Discount rate
	₩	<u>517,815,577</u>				

(*) Valuation techniques and inputs are not disclosed when the carrying value is a reasonable approximation of fair value

SHINHAN FINANCIAL GROUP CO., LTD. AND SUBSIDIARIES

Notes to the Consolidated Financial Statements

December 31, 2021 and 2020

(In millions of won)

4. Financial risk management (continued)

(e) Measurement of fair value (continued)

ii) Financial instruments measured at amortized cost (continued)

- For financial instruments not measured at fair value in the statement of financial position but for which the fair value is disclosed, information on valuation technique and inputs used in measuring fair value of financial instruments classified as level 2 or level 3 at December 31, 2021 and 2020 are as follows:

	December 31, 2020		
	Fair value(*)	Valuation technique	Inputs
Financial instruments classified as level 2 :			
Assets			
Due from banks measured at amortized cost	₩ 29,957,444	DCF	Discount rate
Loans measured at amortized cost	2,187,270	DCF	Discount rate, credit spread, prepayment rate
Securities measured at amortized cost	26,172,786	DCF	Discount rate
Other financial assets	8,661,345	DCF	Discount rate
Financial instruments classified as level 3 :			
Assets			
Due from banks measured at amortized cost	869,919	DCF	Discount rate
Loans measured at amortized cost	356,631,939	DCF	Discount rate, credit spread, prepayment rate
Securities measured at amortized cost	80,451	DCF	Discount rate
Other financial assets	11,698,433	DCF	Discount rate
	₩ <u>436,259,587</u>		
Financial instruments classified as level 2 :			
Liabilities			
Deposits	₩ 156,266,212	DCF	Discount rate
Borrowings	1,768,542	DCF	Discount rate
Debt securities issued	43,684,992	DCF	Discount rate
Other financial liabilities	10,383,020	DCF	Discount rate
Financial instruments classified as level 3 :			
Liabilities			
Deposits	170,272,583	DCF	Discount rate
Borrowings	39,835,395	DCF	Discount rate
		DCF	Discount rate, regression coefficient, correlation coefficient
Debt securities issued	32,419,598		
Other financial liabilities	23,753,108	DCF	Discount rate
	₩ <u>478,383,450</u>		

(*) Valuation techniques and inputs are not disclosed when the carrying value is a reasonable approximation of fair value

SHINHAN FINANCIAL GROUP CO., LTD. AND SUBSIDIARIES

Notes to the Consolidated Financial Statements

December 31, 2021 and 2020

(In millions of won)

4. Financial risk management (continued)

(e) Measurement of fair value (continued)

iii) Changes in gains or losses on valuation at the transaction date for the years ended December 31, 2021 and 2020, are as follows:

	<u>December 31, 2021</u>	<u>December 31, 2020</u>
Beginning balance	₩ (292,599)	(172,859)
New transactions	(206,897)	(347,030)
Recognized in profit for the year	338,971	227,290
Ending balance	₩ <u>(160,525)</u>	<u>(292,599)</u>

(f) Classification by categories of financial instruments

Financial assets and liabilities are measured at fair value or amortized cost. The financial instruments measured at fair value or amortized costs are measured in accordance with the Group's valuation methodologies, which are described in Note 4.(e) Measurement of fair value.

The carrying values of each category of financial assets and financial liabilities as of December 31, 2021 and 2020 is as follows:

	<u>December 31, 2021</u>				
	<u>FVTPL</u>	<u>FVOCI</u>	<u>Amortized cost</u>	<u>Derivatives held for hedging</u>	<u>Total</u>
Assets:					
Cash and due from banks at amortized cost	₩ -	-	28,453,404	-	28,453,404
Due from banks at fair value through profit or loss	34,262	-	-	-	34,262
Securities at fair value through profit or loss	60,686,153	-	-	-	60,686,153
Derivatives assets	3,574,126	-	-	225,063	3,799,189
Loans at fair value through profit or loss	1,683,344	-	-	-	1,683,344
Loans at amortized cost	-	-	389,137,156	-	389,137,156
Securities at fair value through other comprehensive income	-	64,838,323	-	-	64,838,323
Securities at amortized cost	-	-	49,930,076	-	49,930,076
Others	-	-	23,238,932	-	23,238,932
	₩ <u>65,977,885</u>	<u>64,838,323</u>	<u>490,759,568</u>	<u>225,063</u>	<u>621,800,839</u>

SHINHAN FINANCIAL GROUP CO., LTD. AND SUBSIDIARIES

Notes to the Consolidated Financial Statements

December 31, 2021 and 2020

(In millions of won)

4. Financial risk management (continued)

(f) Classification by categories of financial instruments (continued)

The carrying values of each category of financial assets and financial liabilities as of December 31, 2021 and 2020 is as follows (continued):

		December 31, 2021				
		FVTPL	FVTPL liabilities designated	Financial liabilities measured at amortized cost	Derivatives held for hedging	Total
Liabilities:						
Deposits	₩	-	-	364,896,675	-	364,896,675
Financial liabilities at fair value through profit or loss		1,369,225	-	-	-	1,369,225
Financial liabilities designated at FVTPL		-	8,023,870	-	-	8,023,870
Derivatives liabilities		3,207,755	-	-	378,809	3,586,564
Borrowings		-	-	43,167,065	-	43,167,065
Debt securities issued		-	-	80,149,363	-	80,149,363
Others		-	-	29,880,879	-	29,880,879
	₩	<u>4,576,980</u>	<u>8,023,870</u>	<u>518,093,982</u>	<u>378,809</u>	<u>531,073,641</u>

SHINHAN FINANCIAL GROUP CO., LTD. AND SUBSIDIARIES

Notes to the Consolidated Financial Statements

December 31, 2021 and 2020

(In millions of won)

4. Financial risk management (continued)

(f) Classification by categories of financial instruments (continued)

The carrying values of each category of financial assets and financial liabilities as of December 31, 2021 and 2020 is as follows (continued):

	December 31, 2020				
	FVTPL	FVOCI	Amortized cost	Derivatives held for hedging	Total
Assets:					
Cash and due from banks at amortized cost	₩ -	-	33,410,542	-	33,410,542
Due from banks at fair value through profit or loss	63,112	-	-	-	63,112
Securities at fair value through profit or loss	57,011,490	-	-	-	57,011,490
Derivatives assets	5,157,412	-	-	476,503	5,633,915
Loans at fair value through profit or loss	2,016,801	-	-	-	2,016,801
Loans at amortized cost	-	-	356,221,519	-	356,221,519
Securities at fair value through other comprehensive income	-	58,316,112	-	-	58,316,112
Securities at amortized cost	-	-	47,282,623	-	47,282,623
Others	-	-	20,341,191	-	20,341,191
	₩ <u>64,248,815</u>	<u>58,316,112</u>	<u>457,255,875</u>	<u>476,503</u>	<u>580,297,305</u>

	December 31, 2020				
	FVTPL	FVTPL liabilities designated	Financial liabilities measured at amortized cost	Derivatives held for hedging	Total
Liabilities:					
Deposits	₩ -	-	326,416,868	-	326,416,868
Financial liabilities at fair value through profit or loss	1,436,694	-	-	-	1,436,694
Financial liabilities designated at FVTPL	-	8,455,724	-	-	8,455,724
Derivatives liabilities	4,680,064	-	-	336,503	5,016,567
Borrowings	-	-	41,594,064	-	41,594,064
Debt securities issued	-	-	75,134,394	-	75,134,394
Others	-	-	34,129,626	-	34,129,626
	₩ <u>6,116,758</u>	<u>8,455,724</u>	<u>477,274,952</u>	<u>336,503</u>	<u>492,183,937</u>

SHINHAN FINANCIAL GROUP CO., LTD. AND SUBSIDIARIES

Notes to the Consolidated Financial Statements

December 31, 2021 and 2020

(In millions of won)

4. **Financial risk management (continued)**

(g) **Transfer of financial instruments**

i) *Transfers that do not qualify for derecognition*

① Sale of repurchase bonds

Among the Group's sale of repurchase bonds, followings are the details of financial instruments that do not qualify for derecognition because the Group sold under repurchase agreement at a fixed price as of December 31, 2021 and 2020:

	<u>December 31, 2021</u>	<u>December 31, 2020</u>
Transferred asset:		
Securities at FVTPL	₩ 9,883,335	8,915,488
Securities at FVOCI	647,541	1,638,651
Securities at amortized cost	210,490	205,639
	<u>₩ 10,741,366</u>	<u>10,759,778</u>
Associated liabilities:		
Bonds sold under repurchase agreements	₩ 10,709,115	11,075,004

② Securities loaned

If the securities owned by the Group are loaned, the ownership of the securities is transferred, but is required to be returned at the end of the loan period. Therefore, the Group continues to recognize the entire securities loaned as it holds most of the risks and compensation of the securities.

Securities loaned as of December 31, 2021 and 2020 are as follows:

	<u>December 31, 2021</u>	<u>December 31, 2020</u>	<u>Borrowers</u>
Government bonds	₩ 9,044,914	3,213,719	Korea Securities Finance Corp., Korea Securities Depository, etc
Financial institutions bonds	209,594	220,324	Korea Securities Finance Corp., Korea Securities Depository, etc
Equity securities	8,109	99,670	Korea Securities Finance Corp., etc
	<u>₩ 9,262,617</u>	<u>3,533,713</u>	

③ Securitization of financial assets

The Group uses the securitization of financial assets as a means of financing and to transfer risk. Generally, these securitization transactions result in the transfer of contractual cash flows to the debt securities holders issued from the financial asset portfolio. The Group recognizes debt securities issued without derecognition of assets under individual agreements, partially recognizes assets to the extent of the Group's level of involvement in assets, or recognizes rights and obligations arising from the derecognition and transfer of assets as separate assets and liabilities. The Group derecognizes the entire asset only if it transfers contractual rights to the cash flows of financial assets or if it holds contractual rights but bears contractual obligations to pay cash flows to the other party without significant delays or reinvestment and transfers most of the risks and benefits of ownership (e.g., credit risk, interest rate risk, prepayment risk, etc.). For the years ended December 31, 2021 and 2020, the carrying value of financial assets related to securitization transactions that have neither been transferred nor derecognized are ₩11,529,634 million and ₩11,355,488 million, respectively; the carrying values of related liabilities are ₩8,284,109 million and ₩8,351,211 million, respectively.

ii) *Financial instruments qualified for derecognition and continued involvement*

There are no financial instruments which qualify for derecognition and in which the Group has continuing involvements as of December 31, 2021, and 2020.

SHINHAN FINANCIAL GROUP CO., LTD. AND SUBSIDIARIES

Notes to the Consolidated Financial Statements

December 31, 2021 and 2020

(In millions of won)

4. Financial risk management (continued)

(h) Offsetting financial assets and financial liabilities

Financial assets and liabilities subject to offsetting, enforceable master netting arrangements and similar agreements as of December 31, 2021 and 2020 are as follows:

	December 31, 2021					
	Gross amounts of recognized financial assets/ liabilities	Gross amounts of recognized financial assets/ liabilities set off in the statement of financial position	Net amounts of financial assets/ liabilities presented in the statement of financial position	Related amounts not set off in the statement of financial position		Net amount
				Financial instruments	Cash collateral received	
Assets:						
Derivatives(*1)	₩ 3,821,253	-	3,821,253			
Other financial instruments(*1)	7,873,305	-	7,873,305	9,509,183	409,487	1,775,888
Securities repurchased under repurchase agreements and bonds purchased under repurchase agreements(*2)	12,749,800	-	12,749,800	12,618,359	-	131,441
Securities loaned(*2)	2,648,248	-	2,648,248	2,648,248	-	-
Domestic exchange settlement debit(*3)	44,872,022	38,171,649	6,700,373	-	-	6,700,373
Receivables from disposal of securities(*4)	7,082,779	3,477,874	3,604,905	2,668,065	-	936,840
Insurance receivables	70,087	-	70,087	45,849	-	24,238
	₩ <u>79,117,494</u>	<u>41,649,523</u>	<u>37,467,971</u>	<u>27,489,704</u>	<u>409,487</u>	<u>9,568,780</u>
Liabilities:						
Derivatives(*1)(*5)	₩ 11,434,081	-	11,434,081			
Other financial instruments(*1)	6,781,044	-	6,781,044	10,093,812	1,000	8,120,313
Bonds purchased under repurchase agreements(*2)	10,709,115	-	10,709,115	10,492,779	-	216,336
Securities borrowed(*2)	787,767	-	787,767	787,767	-	-
Domestic exchange settlement pending(*3)	40,062,057	38,171,649	1,890,408	1,809,727	-	80,681
Payable from purchase of securities(*4)	7,036,630	3,477,874	3,558,756	2,668,767	-	889,989
Insurance payables	45,940	-	45,940	45,849	-	91
	₩ <u>76,856,634</u>	<u>41,649,523</u>	<u>35,207,111</u>	<u>25,898,701</u>	<u>1,000</u>	<u>9,307,410</u>

SHINHAN FINANCIAL GROUP CO., LTD. AND SUBSIDIARIES

Notes to the Consolidated Financial Statements

December 31, 2021 and 2020

(In millions of won)

4. Financial risk management (continued)

(h) Offsetting financial assets and financial liabilities (continued)

Financial assets and liabilities subject to offsetting, enforceable master netting arrangements and similar agreements as of December 31, 2021 and 2020 are as follows (continued):

(*1) The Group has certain derivative transactions subject to the ISDA (International Derivatives Swaps and Dealers Association) agreement. According to the ISDA agreement, when credit events (e.g. default) of counterparties occur, all derivative agreements are terminated and set off. At the time of termination, the parties to the transaction will offset the amount of payment or payment to each other, and one party will pay the other party a single amount will be paid to the other party.

(*2) Resale and repurchase agreement, securities borrowing and lending agreement are also similar to ISDA agreement with respect to enforceable netting agreements.

(*3) The Group has legally enforceable right to set off and settles financial assets and liabilities on a net basis under normal business terms. Therefore, domestic exchanges settlement receivables (payables) are recorded on a net basis in the consolidated statements of financial position.

(*4) It is an account that deals with bonds and liabilities based on the settlement of listed stocks traded in the market. The Group currently has a legally enforceable right to set off the recognized amounts and intends to settle on a net basis. Therefore, the net amount is presented in the consolidated statement of financial position. The offset amount of related bonds and liabilities based on the settlement of over-the-counter derivatives in-house payment by Central Clearing System is included.

(*5) As of December 31, 2021, the total amount of financial liabilities includes ₩ 8,023,870 million of ELS (equity-linked securities) products and of DLS (derivative linked securities) products. In the course of this transaction, the Group has provided collateral for some transactions. The financial instruments provided as collateral of ₩ 717,841 million are included in the related instruments not offset in the statement of financial position. The total amount of financial liabilities recognized as of December 31, 2021 is ₩ 445,128 million for transactions with the other party with collective offset contracts or similar arrangements.

SHINHAN FINANCIAL GROUP CO., LTD. AND SUBSIDIARIES

Notes to the Consolidated Financial Statements

December 31, 2021 and 2020

(In millions of won)

4. Financial risk management (continued)

(h) Offsetting financial assets and financial liabilities (continued)

Financial assets and liabilities subject to offsetting, enforceable master netting arrangements and similar agreements as of December 31, 2021 and 2020 are as follows: (continued)

	December 31, 2020					
	Gross amounts of recognized financial assets/ liabilities	Gross amounts of recognized financial assets/ liabilities set off in the statement of financial position	Net amounts of financial assets/ liabilities presented in the statement of financial position	Related amounts not set off in the statement of financial position		Net amount
				Financial instruments	Cash collateral received	
Assets:						
Derivatives(*1)	₩ 5,361,225	-	5,361,225			
Other financial instruments(*1)	18,033,663	6,502,695	11,530,968	4,448,496	314,328	12,129,369
Securities repurchased under repurchase agreements and bonds purchased under repurchase agreements(*2)	13,694,305	-	13,694,305	13,185,633	-	508,672
Securities loaned(*2)	1,202,494	-	1,202,494	1,202,494	-	-
Domestic exchange settlement debit(*3)	29,911,693	25,785,507	4,126,186	116,290	-	4,009,896
Receivables from disposal of securities(*4)	29,341	3,140	26,201	-	-	26,201
Insurance receivables	8,374	-	8,374	5,526	-	2,848
	₩ <u>68,241,095</u>	<u>32,291,342</u>	<u>35,949,753</u>	<u>18,958,439</u>	<u>314,328</u>	<u>16,676,986</u>
Liabilities:						
Derivatives(*1)(*5)	₩ 13,153,952	-	13,153,952			
Other financial instruments(*1)	17,340,722	6,502,695	10,838,027	5,490,974	1,000	18,500,005
Bonds purchased under repurchase agreements(*2)	11,065,584	-	11,065,584	10,260,684	-	804,900
Securities borrowed(*2)	897,129	-	897,129	897,129	-	-
Domestic exchange settlement pending(*3)	31,605,249	25,785,507	5,819,742	4,099,248	-	1,720,494
Payable from purchase of securities(*4)	3,148	3,140	8	8	-	-
Insurance payables	5,742	-	5,742	5,526	-	216
	₩ <u>74,071,526</u>	<u>32,291,342</u>	<u>41,780,184</u>	<u>20,753,569</u>	<u>1,000</u>	<u>21,025,615</u>

SHINHAN FINANCIAL GROUP CO., LTD. AND SUBSIDIARIES

Notes to the Consolidated Financial Statements

December 31, 2021 and 2020

(In millions of won)

4. Financial risk management (continued)

(h) Offsetting financial assets and financial liabilities (continued)

Financial assets and liabilities subject to offsetting, enforceable master netting arrangements and similar agreements as of December 31, 2021 and 2020 are as follows (continued):

(*1) The Group has certain derivative transactions subject to the ISDA (International Derivatives Swaps and Dealers Association) agreement. According to the ISDA agreement, when credit events (e.g. default) of counterparties occur, all derivative agreements are terminated and set off. At the time of termination, the parties to the transaction will offset the amount of payment or payment to each other, and one party will pay the other party a single amount will be paid to the other party.

(*2) Resale and repurchase agreement, securities borrowing and lending agreement are also similar to ISDA agreement with respect to enforceable netting agreements.

(*3) The Group has legally enforceable right to set off and settles financial assets and liabilities on a net basis under normal business terms. Therefore, domestic exchanges settlement receivables (payables) are recorded on a net basis in the consolidated statements of financial position.

(*4) It is an account that deals with bonds and liabilities based on the settlement of listed stocks traded in the market. The Group currently has a legally enforceable right to set off the recognized amounts and intends to settle on a net basis. Therefore, the net amount is presented in the consolidated statement of financial position. The offset amount of related bonds and liabilities based on the settlement of over-the-counter derivatives in-house payment by Central Clearing System is included.

(*5) As of December 31, 2020, the total amount of financial liabilities includes ₩ 8,455,724 million of ELS (equity-linked securities) products and of DLS (derivative linked securities) products. In the course of this transaction, the Group has provided collateral for some transactions. The financial instruments provided as collateral of ₩ 1,087,349 million are included in the related instruments not offset in the statement of financial position. The total amount of financial liabilities recognized as of December 31, 2020 is ₩ 693,017 million for transactions with the other party with collective offset contracts or similar arrangements.

SHINHAN FINANCIAL GROUP CO., LTD. AND SUBSIDIARIES

Notes to the Consolidated Financial Statements

December 31, 2021 and 2020

(In millions of won)

4. Financial risk management (continued)

(i) Capital risk management

The criteria for capital adequacy to be complied with by the Group are 8.0% or more of the total equity capital ratio, 6.0% or higher of the basic capital ratio, and 4.5% or more of the common stock capital ratio. In addition, the minimum regulatory BIS capital ratio, which should be maintained additionally to increase the ability to absorb losses, has been raised to up to 14% as the capital regulation based on the Basel III standard is enforced from 2016. This is based on the addition of capital conservation capital (2.5%p) and domestic system-critical banks (D-SIB) capital (1.0%p) and economic response capital (2.5%p) to the existing lowest common equity capital ratio, and economic response capital can be charged up to 2.5%p during credit expansion period. As of December 31, 2021, the minimum regulatory BIS capital ratio to be observed is 11.5%, which is the standard for applying capital conservation capital (2.5%p), D-SIB capital (1.0%p), and economic response capital (0%p).

Basel III capital ratio is the concept of 'International Agreement on the Measurement and Standards of Equity Capital' of the Basel Bank Supervisory Commission of BIS (International Settlement Bank). It is calculated as '(common stock capital (after deduction of deductions) + other basic capital + supplementary capital) ÷ risk weighted assets'.

The capital of common stock can be the first to make up for the loss of the financial holding company. The capital of common stock consists of capital stock, capital reserve, retained earnings and other, which will not be redeemed until the liquidation and will be redeemed at the last during the liquidation. Other basic capital consists of capital securities that meet certain requirements as capital of permanent nature. Complementary capital is capital that can compensate for losses of financial holding companies during liquidation, and consists of capital securities, etc. that meet certain requirements. The deduction items are those held by the Group as assets or capital items, but do not contribute to the ability to absorb losses. Unless otherwise noted, it will be deducted from common stock capital.

The capital ratio of the Group based on Basel III is as of December 31, 2021 and 2020 are as follows:

		<u>December 31, 2021</u>	<u>December 31, 2020</u>
Capital :			
Tier I common equity capital	₩	35,469,554	32,461,864
Additional tier I capital		4,965,931	3,805,372
Tier I capital		40,435,485	36,267,236
Tier II capital		3,427,951	3,441,841
Total capital (A)	₩	<u>43,863,436</u>	<u>39,709,077</u>
Total risk-weighted assets (B)	₩	270,692,183	252,321,426
Capital adequacy ratio (A/B)		16.20%	15.74%
Tier I capital adequacy ratio		14.94%	14.37%
Common stock ratio		13.10%	12.87%

(*) As of December 31, 2021, the Group has maintained an appropriate consolidated equity capital ratio according to the BIS equity capital regulation.

SHINHAN FINANCIAL GROUP CO., LTD. AND SUBSIDIARIES

Notes to the Consolidated Financial Statements

December 31, 2021 and 2020

(In millions of won)

5. Significant estimates and judgments

The preparation of financial statements requires the Group to make estimates and assumptions concerning the future. Management also needs to exercise judgment in applying the Group's accounting policies. Estimates and assumptions are continually evaluated and are based on historical experience and other factors, including expectations of future events that are believed to be reasonable under the circumstances. As the resulting accounting estimates will, by definition, seldom equal the related actual results, it can contain a significant risk of causing a material adjustment. The estimates and assumptions that have a significant risk of causing a material adjustment to the carrying values of assets and liabilities within the next financial year are discussed below.

(a) Estimation of impairment of goodwill

The Group reviews the goodwill annually in accordance with the accounting policy in Note 3. The recoverable amount of the cash-generating unit (group) is determined based on the value-in-use calculation. These calculations are based on estimates.

(b) Income taxes

The Group is subject to tax laws from various countries. In the normal course of business, there are various types of transactions and different accounting methods that may add uncertainties to the decision of the final income taxes. The Group has recognized current and deferred taxes that reflect tax consequences based on the best estimates in which the Group expects, at the end of the reporting period, to recover or settle the carrying value of its assets and liabilities. However, actual income taxes in the future may not be identical to the recognized deferred tax assets and liabilities, and this difference can affect current and deferred tax at the period when the final tax effect is determined.

(c) Fair value of financial instruments

The fair values of financial instruments (e.g. over-the-counter derivatives) which are not actively traded in the market are determined by using valuation techniques. The Group determines valuation techniques and assumptions based on significant market conditions at the end of each reporting period. Diverse valuation techniques are used to determine the fair value of financial instruments, from generic valuation techniques to internally developed valuation models that incorporate various types of assumptions and variables.

(d) Allowance for credit loss, guarantees and unused loan commitments

The Group determines and recognizes allowances for losses on debt securities, loans and other receivables measured at amortized cost or FVOCI, and recognizes provisions for guarantees and unused loan commitments through impairment testing. The accuracy of allowances and provisions for credit losses are determined by the estimation of expected cash flows for individually assessed allowances, and methodology and assumptions used for collectively assessed allowances and provisions for groups of loans, guarantees and unused loan commitments.

SHINHAN FINANCIAL GROUP CO., LTD. AND SUBSIDIARIES

Notes to the Consolidated Financial Statements

December 31, 2021 and 2020

(In millions of won)

6. Investment in subsidiaries

(a) The summarized financial information of the controlling company and the Group's major subsidiaries as of December 31, 2021 and 2020 is as follows:

Investees(*1)(*2)	December 31, 2021			December 31, 2020		
	Asset balance	Liability balance	Equity balance	Asset balance	Liability balance	Equity balance
Shinhan Financial Group(separate)	₩ 36,815,893	10,410,517	26,405,376	35,483,914	10,426,817	25,057,097
Shinhan Bank	467,435,213	438,199,575	29,235,638	427,675,103	400,009,589	27,665,514
Shinhan Card Co., Ltd.	38,472,228	31,737,225	6,735,003	34,885,223	28,465,675	6,419,548
Shinhan Investment Corp.	44,446,803	39,421,314	5,025,489	46,632,433	42,258,341	4,374,092
Shinhan Life Insurance Co., Ltd.(*3)	70,535,556	65,382,992	5,152,564	36,777,496	34,232,052	2,545,444
Orange Life Insurance Co., Ltd.(*3)	-	-	-	33,813,587	30,574,073	3,239,514
Shinhan Capital Co., Ltd.	10,921,698	9,189,041	1,732,657	8,901,349	7,710,010	1,191,339
Jeju Bank	6,944,214	6,428,269	515,945	6,531,838	6,022,397	509,441
Shinhan Credit Information Co., Ltd.	31,377	12,334	19,043	27,806	10,826	16,980
Shinhan Alternative Investment Management Inc.	114,973	70,449	44,524	87,053	71,591	15,462
Shinhan Asset Management Co., Ltd.	242,760	40,181	202,579	191,127	20,530	170,597
SHC Management Co., Ltd.	9,636	-	9,636	9,644	-	9,644
Shinhan DS	92,591	52,804	39,787	95,150	70,916	24,234
Shinhan Savings Bank	2,644,942	2,413,176	231,766	1,842,231	1,635,433	206,798
Asia Trust Co., Ltd.	373,267	122,038	251,229	259,899	85,274	174,625
Shinhan AITAS Co., Ltd.	90,116	9,786	80,330	87,378	12,159	75,219
Shinhan REITs Management Co., Ltd.	63,026	10,584	52,442	52,555	8,582	43,973
Shinhan AI Co., Ltd.	44,031	2,563	41,468	42,903	1,890	41,013
Shinhan Venture Investment Co., Ltd.	98,914	23,331	75,583	72,550	12,697	59,853

(*1) The consolidated financial statements of the consolidated subsidiaries are based on consolidated financial statements, if applicable.

(*2) Trusts, beneficiary certificates, securitization special limited liability companies, associates and private equity investment specialists that are not actually operating their own business are excluded.

(*3) Shinhan Life Insurance Co., Ltd., and Orange Life Insurance Co., Ltd. were merged on July 1, 2021. After the merger, the name is Shinhan Life Insurance Co., Ltd.

SHINHAN FINANCIAL GROUP CO., LTD. AND SUBSIDIARIES

Notes to the Consolidated Financial Statements

December 31, 2021 and 2020

(In millions of won)

6. Investment in subsidiaries (continued)

(b) The summarized income information of the controlling company and the Group's major subsidiaries for the years ended December 31, 2021 and 2020 is as follows:

Investees(*1)(*2)	December 31, 2021			December 31, 2020		
	Operating Revenue	Net Income(*3)	Comprehensive Income(*3)	Operating Revenue	Net Income(*3)	Comprehensive Income(*3)
Shinhan Financial Group (separate)	₩ 1,875,675	1,413,956	1,413,675	1,718,407	1,274,443	1,274,892
Shinhan Bank	23,540,347	2,494,894	2,396,829	25,049,392	2,078,232	1,911,575
Shinhan Card Co., Ltd.	4,359,627	676,297	710,090	4,091,178	606,554	599,451
Shinhan Investment Corp.	7,592,350	320,662	366,000	9,290,965	154,531	147,210
Shinhan Life Insurance Co., Ltd.	7,079,569	174,811	(162,161)	5,405,933	177,834	227,596
Orange Life Insurance Co., Ltd.(*4)	2,112,353	216,826	(96,157)	4,456,340	279,282	132,425
Shinhan Capital Co., Ltd.	783,890	274,855	275,760	626,455	160,583	162,134
Jeju Bank	204,543	18,446	11,739	214,615	17,521	16,557
Shinhan Credit Information Co., Ltd.	42,417	1,936	2,079	42,658	1,493	1,650
Shinhan Alternative Investment Management Inc.	28,010	9,163	9,163	17,219	3,433	3,433
Shinhan Asset Management Co., Ltd.	107,598	32,152	32,066	88,870	26,663	26,663
SHC Management Co., Ltd.	-	(7)	(7)	70	5	5
Shinhan DS	244,445	4,100	5,653	164,327	1,862	2,845
Shinhan Savings Bank	163,643	30,310	30,037	123,590	26,953	26,888
Asia Trust Co., Ltd.	144,971	76,455	76,604	102,816	45,791	45,765
Shinhan AITAS Co., Ltd.	53,005	9,816	9,816	58,599	13,020	12,954
Shinhan REITs Management Co., Ltd.	16,440	8,481	8,469	12,176	3,764	3,764
Shinhan AI Co., Ltd.	12,106	478	455	10,246	304	284
Shinhan Venture Investment Co., Ltd.(*5)	32,134	15,929	15,750	3,500	(1,146)	(1,015)

(*1) The consolidated financial statements of the consolidated subsidiaries are based on consolidated financial statements, if applicable.

(*2) Trusts, beneficiary certificates, securitization special limited liability companies, associates and private equity investment specialists that are not actually operating their own business are excluded.

(*3) This amount includes non-controlling interests.

(*4) For the Orange Life Insurance Co., Ltd., the amount is from the consolidated statements of operating revenue, net income and comprehensive income for six months before the merger date.

(*5) For the acquired company, the amount is from the consolidated statements of comprehensive income for the period after the acquisition point.

SHINHAN FINANCIAL GROUP CO., LTD. AND SUBSIDIARIES

Notes to the Consolidated Financial Statements

December 31, 2021 and 2020

(In millions of won)

6. Investment in subsidiaries (continued)

(c) Change in the scope of consolidation

i) Change in consolidated subsidiaries for the year ended December 31, 2021 are as follows:

	Company	Description
Included	Shinhan Life Insurance Vietnam Co., Ltd.	Newly acquired subsidiary
Included	Shinhan CubeOn Co., Ltd.	Newly acquired subsidiary
Excluded	Orange Life Insurance Co., Ltd.	Extinguished due to merger with Shinhan Life Insurance Co., Ltd.

(*) Subsidiaries such as trust, beneficiary certificate, corporate restructuring fund and private equity fund which are not actually operating their own business are excluded.

ii) Change in consolidated subsidiaries for the year ended December 31, 2020 are as follows:

	Company	Description
Included	Shinhan Venture Investment Co., Ltd.	Newly acquired subsidiary
Included	SBJDNX	Newly invested subsidiary
Included	Shinhan Financial Plus Co., Ltd	Newly invested subsidiary
Excluded	Shinhan Asia Ltd.	Liquidation

(*) Subsidiaries such as trust, beneficiary certificate, corporate restructuring fund and private equity fund which are not actually operating their own business are excluded.

SHINHAN FINANCIAL GROUP CO., LTD. AND SUBSIDIARIES

Notes to the Consolidated Financial Statements

December 31, 2021 and 2020

(In millions of won)

7. Operating segments

(a) Segment information

The general descriptions by operating segments as of December 31, 2021 are as follows:

<u>Segment</u>	<u>Description</u>
Banking	Credit to customers, lending to and receiving deposits from customers, and their accompanying work
Credit card	Sales of credit cards, cash services, card loan services, installment financing, lease and their accompanying work
Securities	Securities trading, consignment trading, underwriting and their accompanying work
Life insurance	Life insurance business and their accompanying work
Credit	Facility rental, new technology business financing, others and their accompanying work
Others	Business segments that do not belong to the above segments, such as real estate trust, investment advisory services, venture business investment and other remaining business

SHINHAN FINANCIAL GROUP CO., LTD. AND SUBSIDIARIES

Notes to the Consolidated Financial Statements

December 31, 2021 and 2020

(In millions of won)

7. Operating segments (continued)

(b) The following tables provide information of income and expense for each operating segment for the years ended December 31, 2021 and 2020:

	December 31, 2021							Consolidation adjustment	Total
	Banking	Credit card	Securities	Life insurance	Credit	Others			
Net interest income	₩ 6,738,165	1,799,153	517,296	1,620,266	231,679	68,991	(206,225)	10,769,325	
Net fees and commission income	818,426	634,716	601,793	170,781	28,812	415,212	5,257	2,674,997	
Reversal of (provision for) allowance for credit loss	(364,291)	(442,668)	(80,134)	(21,760)	(34,064)	(35,421)	3,653	(974,685)	
General and administrative expenses	(3,409,144)	(790,733)	(696,278)	(557,292)	(80,056)	(366,149)	156,564	(5,743,088)	
Other income (expense), net	(305,508)	(179,695)	234,209	(660,416)	194,564	177,912	(235,519)	(774,453)	
Operating income	3,477,648	1,020,773	576,886	551,579	340,935	260,545	(276,270)	5,952,096	
Equity method income (loss)	25,401	(1,109)	65,341	(739)	29,644	16,201	23,861	158,600	
Income tax expense	821,201	266,798	94,864	139,106	94,329	71,120	(16,382)	1,471,036	
Profit for the year	₩ 2,417,880	771,757	320,662	391,637	274,855	205,880	(270,043)	4,112,628	
Controlling interest	₩ 2,417,361	770,457	320,783	391,637	274,855	205,880	(361,719)	4,019,254	
Non-controlling interests	519	1,300	(121)	-	-	-	91,676	93,374	

SHINHAN FINANCIAL GROUP CO., LTD. AND SUBSIDIARIES

Notes to the Consolidated Financial Statements

December 31, 2021 and 2020

(In millions of won)

7. Operating segments (continued)

(b) The following tables provide information of income and expense for each operating segment for the years ended December 31, 2021 and 2020 (continued):

		December 31, 2020							
		Banking	Credit card	Securities	Life insurance	Credit	Others	Consolidation adjustment	Total
Net interest income	₩	6,037,632	1,755,039	517,044	1,608,953	158,817	7,805	(202,590)	9,882,700
Net fees and commission income		822,408	483,486	544,183	162,284	21,346	347,004	2,222	2,382,933
Reversal of (provision for) allowance for credit loss		(690,084)	(483,883)	(111,796)	(12,236)	(63,429)	(22,522)	1,771	(1,382,179)
General and administrative expenses		(3,237,641)	(698,796)	(565,485)	(463,439)	(58,494)	(314,097)	125,479	(5,212,473)
Other income (expense), net		(130,488)	(169,304)	(11,348)	(727,530)	120,735	140,138	36,552	(741,245)
Operating income		2,801,827	886,542	372,598	568,032	178,975	158,328	(36,566)	4,929,736
Equity method income (loss)		(811)	-	37,760	(1,244)	32,133	(2,489)	94,184	159,533
Income tax expense		673,972	251,357	48,464	156,698	49,211	44,883	31,210	1,255,795
Profit for the year	₩	<u>1,999,002</u>	<u>703,305</u>	<u>154,531</u>	<u>457,116</u>	<u>160,583</u>	<u>112,992</u>	<u>(89,453)</u>	<u>3,498,076</u>
Controlling interest	₩	1,998,563	703,204	154,772	457,116	160,583	112,992	(172,635)	3,414,595
Non-controlling interests		439	101	(241)	-	-	-	83,182	83,481

SHINHAN FINANCIAL GROUP CO., LTD. AND SUBSIDIARIES

Notes to the Consolidated Financial Statements

December 31, 2021 and 2020

(In millions of won)

7. Operating segments (continued)

(c) Interest gains and losses from segment external customers and cross-sector interest gains and losses for the years ended December 31, 2021 and 2020 are as follows:

		December 31, 2021							
		Banking	Credit card	Securities	Life insurance	Credit	Others	Consolidation adjustment(*)	Total
Net interest income from:									
External customers (*)	₩	6,741,279	1,849,209	534,969	1,617,186	241,035	781	(215,134)	10,769,325
Internal transactions		(3,114)	(50,056)	(17,673)	3,080	(9,356)	68,210	8,909	-
	₩	<u>6,738,165</u>	<u>1,799,153</u>	<u>517,296</u>	<u>1,620,266</u>	<u>231,679</u>	<u>68,991</u>	<u>(206,225)</u>	<u>10,769,325</u>

(*) Consolidated adjustment to net interest income from external customers is from the securities and others which were measured in fair values as a part of business combination accounting.

		December 31, 2020							
		Banking	Credit card	Securities	Life insurance	Credit	Others	Consolidation adjustment(*)	Total
Net interest income from:									
External customers (*)	₩	6,037,205	1,809,149	526,167	1,605,575	169,192	(54,902)	(209,686)	9,882,700
Internal transactions		427	(54,110)	(9,123)	3,378	(10,375)	62,707	7,096	-
	₩	<u>6,037,632</u>	<u>1,755,039</u>	<u>517,044</u>	<u>1,608,953</u>	<u>158,817</u>	<u>7,805</u>	<u>(202,590)</u>	<u>9,882,700</u>

(*) Consolidated adjustment to net interest income from external customers is from the securities and others which were measured in fair values as a part of business combination accounting.

SHINHAN FINANCIAL GROUP CO., LTD. AND SUBSIDIARIES

Notes to the Consolidated Financial Statements

December 31, 2021 and 2020

(In millions of won)

7. Operating segments (continued)

(d) The following tables provide information of net fees and commission income (expense) of each operating segment for the years ended December 31, 2021 and 2020.

		December 31, 2021							
		Banking	Credit card	Securities	Life insurance	Credit	Others	Consolidation adjustment	Total
Net fees and commission income from:									
External customers	₩	863,879	681,129	615,414	181,345	27,351	305,879	-	2,674,997
Internal transactions		(45,453)	(46,413)	(13,621)	(10,564)	1,461	109,333	5,257	-
	₩	<u>818,426</u>	<u>634,716</u>	<u>601,793</u>	<u>170,781</u>	<u>28,812</u>	<u>415,212</u>	<u>5,257</u>	<u>2,674,997</u>
		December 31, 2020							
		Banking	Credit card	Securities	Life insurance	Credit	Others	Consolidation adjustment	Total
Net fees and commission income from:									
External customers	₩	859,225	531,394	553,308	173,865	22,381	242,760	-	2,382,933
Internal transactions		(36,817)	(47,908)	(9,125)	(11,581)	(1,035)	104,244	2,222	-
	₩	<u>822,408</u>	<u>483,486</u>	<u>544,183</u>	<u>162,284</u>	<u>21,346</u>	<u>347,004</u>	<u>2,222</u>	<u>2,382,933</u>

SHINHAN FINANCIAL GROUP CO., LTD. AND SUBSIDIARIES

Notes to the Consolidated Financial Statements

December 31, 2021 and 2020

(In millions of won)

7. Operating segments (continued)

(e) Financial information of geographical area

The following table provides information of income from external consumers by geographical area for the years ended December 31, 2021 and 2020.

	<u>December 31, 2021</u>	<u>December 31, 2020</u>
Domestic	₩ 5,404,278	4,436,252
Overseas	547,818	493,484
	<u>₩ 5,952,096</u>	<u>4,929,736</u>

The following table provides information of non-current assets by geographical area as of December 31, 2021 and 2020.

	<u>December 31, 2021</u>	<u>December 31, 2020</u>
Domestic	₩ 10,029,650	9,734,468
Overseas	336,687	351,083
	<u>₩ 10,366,337</u>	<u>10,085,551</u>

(*) Non-current assets comprise property and equipment, intangible assets and investment properties.

SHINHAN FINANCIAL GROUP CO., LTD. AND SUBSIDIARIES

Notes to the Consolidated Financial Statements

December 31, 2021 and 2020

(In millions of won)

8. Cash and due from banks at amortized cost

(a) Cash and due from banks at amortized cost as of December 31, 2021 and 2020 are as follows:

	<u>December 31, 2021</u>	<u>December 31, 2020</u>
Cash and cash equivalents		
Cash	₩ 4,194,831	1,782,301
Cash equivalents	26,560	22,979
	<u>4,221,391</u>	<u>1,805,280</u>
Deposits denominated in Korean won:		
Reserve deposits	9,851,064	16,957,521
Time deposits	892,053	950,624
Other	2,701,873	3,953,337
	<u>13,444,990</u>	<u>21,861,482</u>
Deposits denominated in foreign currency:		
Deposits	6,731,190	5,576,206
Time deposits	2,148,955	2,721,849
Other	1,924,601	1,455,732
	<u>10,804,746</u>	<u>9,753,787</u>
Allowance for credit losses	(17,723)	(10,007)
	<u>₩ 28,453,404</u>	<u>33,410,542</u>

(b) Restricted due from banks at amortized cost as of December 31, 2021 and 2020 are as follows:

	<u>December 31, 2021</u>	<u>December 31, 2020</u>	<u>Related Regulations or Acts</u>
Deposits denominated in Korean won:			
Reserve deposits	₩ 9,851,064	16,957,521	Article 55 of the Bank of Korea Act Article 28 and 70 of the Bank of Korea Act, Article 74 of the Capital Markets and Financial Investment Business Act, etc.
Other	1,174,670	2,390,761	
	<u>11,025,734</u>	<u>19,348,282</u>	
Deposits denominated in foreign currency	2,870,908	2,621,129	Articles of the Bank of Korea Act, New York State Banking Act, derivatives, etc.
	<u>₩ 13,896,642</u>	<u>21,969,411</u>	

SHINHAN FINANCIAL GROUP CO., LTD. AND SUBSIDIARIES

Notes to the Consolidated Financial Statements

December 31, 2021 and 2020

(In millions of won)

9. Financial assets at fair value through profit or loss

(a) Financial assets at fair value through profit or loss as of December 31, 2021 and 2020 are as follows:

	<u>December 31, 2021</u>	<u>December 31, 2020</u>
Debt instruments:		
Governments	₩ 3,961,045	4,248,448
Financial institutions	13,449,550	13,997,922
Corporations	9,618,302	9,356,842
Stocks with put option	627,275	583,590
Equity investment with put option	2,625,297	1,860,195
Beneficiary certificates	13,386,212	12,451,709
Commercial papers	7,042,045	6,369,854
CMA	3,591,822	2,806,485
Others(*)	3,925,599	3,411,647
	<u>58,227,147</u>	<u>55,086,692</u>
Equity instruments:		
Stocks	2,182,829	1,627,020
Equity investment	12,962	1,697
Others	179,524	107,742
	<u>2,375,315</u>	<u>1,736,459</u>
	₩ <u>60,602,462</u>	<u>56,823,151</u>
Other:		
Loans at FVTPL	₩ 1,683,344	2,016,801
Due from banks at fair value	34,262	63,112
Gold/silver deposits	83,691	188,339
	₩ <u>62,403,759</u>	<u>59,091,403</u>

(*) As of December 31, 2021 and 2020, restricted reserve for claims of customers' deposits (trusts) are ₩ 2,080,626 million and ₩ 1,907,210 million, respectively.

SHINHAN FINANCIAL GROUP CO., LTD. AND SUBSIDIARIES

Notes to the Consolidated Financial Statements

December 31, 2021 and 2020

(In millions of won)

9. Financial assets at fair value through profit or loss (continued)

(b) Financial assets to which overlay approach are applied in accordance with K-IFRS No. 1109 'Financial Instruments' and K-IFRS No. 1104 'Insurance Contracts' as of December 31, 2021 and 2020 are as follows:

	<u>December 31, 2021</u>	<u>December 31, 2020</u>
Due from banks at fair value through profit or loss	₩ 34,262	63,112
Securities at fair value through profit or loss	4,903,275	4,865,908
	<u>₩ 4,937,537</u>	<u>4,929,020</u>

A financial asset is eligible for designation for the overlay approach, if it is measured at fair value through profit or loss applying K-IFRS No. 1109 but would not have been measured at fair value through profit or loss in its entirety applying K-IFRS No. 1039; and it is not held in respect of an activity that is not associated with contracts within the scope of K-IFRS No. 1104.

The reclassified amounts between profit or loss and other comprehensive income due to the overlay approach as of and for the years ended December 31, 2021 and 2020 are as follows:

	<u>December 31, 2021</u>			
	<u>Profit or loss</u>		<u>Other comprehensive income(*)</u>	
	<u>By K-IFRS No. 1109</u>	<u>By K-IFRS No. 1039</u>	<u>Amount</u>	<u>Tax effect</u>
Net gain (loss) on valuation of financial assets at fair value through profit or loss	₩ 130,170	83,288	46,882	(12,893)
Net gain (loss) on disposal of financial assets at fair value through profit or loss	(2,668)	87,217	(89,885)	24,719
	<u>₩ 127,502</u>	<u>170,505</u>	<u>(43,003)</u>	<u>11,826</u>

(*) The amount of the policyholders equity adjustment for the reclassification of other comprehensive income is ₩11,079 million for the years ended December 31, 2021.

	<u>December 31, 2020</u>			
	<u>Profit or loss</u>		<u>Other comprehensive income(*)</u>	
	<u>By K-IFRS No. 1109</u>	<u>By K-IFRS No. 1039</u>	<u>Amount</u>	<u>Tax effect</u>
Net gain (loss) on valuation of financial assets at fair value through profit or loss	₩ 123,808	(21,488)	145,301	(39,958)
Net gain (loss) on disposal of financial assets at fair value through profit or loss	53,806	62,926	(9,120)	2,508
Net gain (loss) on foreign currency conversion of financial assets at fair value through profit or loss	74	-	74	(20)
	<u>₩ 177,688</u>	<u>41,438</u>	<u>136,255</u>	<u>(37,470)</u>

(*) The amount of the policyholders equity adjustment for the reclassification of other comprehensive income is ₩(8,487) million for the years ended December 31, 2020.

SHINHAN FINANCIAL GROUP CO., LTD. AND SUBSIDIARIES

Notes to the Consolidated Financial Statements

December 31, 2021 and 2020

(In millions of won)

10. Derivatives

(a) The notional amounts of derivatives outstanding as of December 31, 2021 and 2020 are as follows:

	<u>December 31, 2021</u>	<u>December 31, 2020</u>
Foreign currency related:		
Over the counter:		
Currency forwards	₩ 146,169,864	117,566,233
Currency swaps	36,548,884	33,562,251
Currency options	2,270,594	2,501,983
	<u>184,989,342</u>	<u>153,630,467</u>
Exchange traded:		
Currency futures	641,104	1,102,534
	<u>185,630,446</u>	<u>154,733,001</u>
Interest rates related:		
Over the counter:		
Interest rate forwards and swaps	35,518,719	36,205,843
Interest rate options	258,460	324,238
	<u>35,777,179</u>	<u>36,530,081</u>
Exchange traded:		
Interest rate futures	3,293,821	2,465,374
Interest rate options	54,890	-
Interest rate swaps(*)	72,898,275	68,475,400
	<u>76,246,986</u>	<u>70,940,774</u>
	<u>112,024,165</u>	<u>107,470,855</u>
Credit related:		
Over the counter:		
Credit swaps	4,737,329	4,536,626
Equity related:		
Over the counter:		
Equity swaps and forwards	2,073,995	2,628,661
Equity options	677,824	508,686
	<u>2,751,819</u>	<u>3,137,347</u>
Exchange traded:		
Equity futures	1,678,070	1,638,126
Equity options	3,298,673	4,277,882
	<u>4,976,743</u>	<u>5,916,008</u>
	<u>7,728,562</u>	<u>9,053,355</u>
Commodity related:		
Over the counter:		
Commodity swaps and forwards	789,930	537,351
Commodity options	11,500	-
	<u>801,430</u>	<u>537,351</u>
Exchange traded:		
Commodity futures and options	158,550	263,460
	<u>959,980</u>	<u>800,811</u>
Hedge:		
Currency forwards	1,279,598	1,281,945
Currency swaps	3,726,939	4,328,333
Interest rate forwards and swaps	8,695,960	7,844,392
	<u>13,702,497</u>	<u>13,454,670</u>
	<u>₩ 324,782,979</u>	<u>290,049,318</u>

(*) The notional amounts of derivatives outstanding those will be settled in the 'Central Counter Party (CCP)' system.

SHINHAN FINANCIAL GROUP CO., LTD. AND SUBSIDIARIES

Notes to the Consolidated Financial Statements

December 31, 2021 and 2020

(In millions of won)

10. Derivatives (continued)

(b) Fair values of derivative instruments as of December 31, 2021 and 2020 are as follows:

	December 31, 2021		December 31, 2020	
	Assets	Liabilities	Assets	Liabilities
Foreign currency related:				
Over the counter:				
Currency forwards	₩ 2,183,315	1,797,419	3,135,319	3,021,258
Currency swaps	651,292	748,302	1,145,619	979,022
Currency options	12,218	11,591	33,253	31,871
	<u>2,846,825</u>	<u>2,557,312</u>	<u>4,314,191</u>	<u>4,032,151</u>
Exchange traded:				
Currency futures	12	210	90	186
	<u>2,846,837</u>	<u>2,557,522</u>	<u>4,314,281</u>	<u>4,032,337</u>
Interest rates related:				
Over the counter:				
Interest rate forwards and swaps	166,855	303,227	311,403	363,297
Interest rate options	3,748	611	2,148	2,217
	<u>170,603</u>	<u>303,838</u>	<u>313,551</u>	<u>365,514</u>
Exchange traded:				
Interest rate futures	1,701	1,828	900	422
Interest rate options	83	-	-	-
	<u>1,784</u>	<u>1,828</u>	<u>900</u>	<u>422</u>
	<u>172,387</u>	<u>305,666</u>	<u>314,451</u>	<u>365,936</u>
Credit related:				
Over the counter:				
Credit swaps	493,829	65,103	273,578	29,682
Equity related:				
Over the counter:				
Equity swap and forwards	28,803	69,880	122,034	48,218
Equity options	3,884	8,671	2,750	9,840
	<u>32,687</u>	<u>78,551</u>	<u>124,784</u>	<u>58,058</u>
Exchange traded:				
Equity futures	817	19,903	34,816	7,711
Equity options	6,324	167,237	77,973	153,461
	<u>7,141</u>	<u>187,140</u>	<u>112,789</u>	<u>161,172</u>
	<u>39,828</u>	<u>265,691</u>	<u>237,573</u>	<u>219,230</u>
Commodity related:				
Over the counter:				
Commodity swaps and forwards	18,557	3,149	5,949	32,693
Commodity options	-	8,406	-	-
	<u>18,557</u>	<u>11,555</u>	<u>5,949</u>	<u>32,693</u>
Exchange traded:				
Commodity futures and options	2,688	2,218	11,580	186
	<u>21,245</u>	<u>13,773</u>	<u>17,529</u>	<u>32,879</u>
Hedge:				
Currency forwards	106	46,139	91,747	10,507
Currency swaps	63,560	79,407	65,256	186,150
Interest rate forwards and swaps	161,397	253,263	319,500	139,846
	<u>225,063</u>	<u>378,809</u>	<u>476,503</u>	<u>336,503</u>
₩	<u>3,799,189</u>	<u>3,586,564</u>	<u>5,633,915</u>	<u>5,016,567</u>

SHINHAN FINANCIAL GROUP CO., LTD. AND SUBSIDIARIES

Notes to the Consolidated Financial Statements

December 31, 2021 and 2020

(In millions of won)

10. Derivatives (continued)

(c) Gain or loss on valuation of derivatives for the years ended December 31, 2021 and 2020 are as follows:

	<u>December 31, 2021</u>	<u>December 31, 2020</u>
Foreign currency related:		
Over the counter:		
Currency forwards	₩ 268,310	(108,854)
Currency swaps	(201,500)	210,072
Currency options	2,007	4,979
	<u>68,817</u>	<u>106,197</u>
Exchange traded:		
Currency futures	(199)	(96)
	<u>68,618</u>	<u>106,101</u>
Interest rates related:		
Over the counter:		
Interest rate forwards and swaps	(142,703)	(73,926)
Interest rate options	792	(372)
	<u>(141,911)</u>	<u>(74,298)</u>
Exchange traded:		
Interest rate futures	(4)	4,236
	<u>(141,915)</u>	<u>(70,062)</u>
Credit related:		
Over the counter:		
Credit swaps	192,729	7,255
Equity related:		
Over the counter:		
Equity swap and forwards	(176,430)	(15,979)
Equity options	3,307	(2,082)
	<u>(173,123)</u>	<u>(18,061)</u>
Exchange traded:		
Equity futures	(19,408)	26,305
Equity options	32,555	196,288
	<u>13,147</u>	<u>222,593</u>
	<u>(159,976)</u>	<u>204,532</u>
Commodity related:		
Over the counter:		
Commodity swaps and forwards	(19,097)	(13,519)
Commodity options	(4,956)	-
	<u>(24,053)</u>	<u>(13,519)</u>
Exchange traded:		
Commodity futures and options	469	11,374
	<u>(23,584)</u>	<u>(2,145)</u>
Hedge	<u>(203,563)</u>	<u>120,700</u>
	<u>₩ (267,691)</u>	<u>366,381</u>

SHINHAN FINANCIAL GROUP CO., LTD. AND SUBSIDIARIES

Notes to the Consolidated Financial Statements

December 31, 2021 and 2020

(In millions of won)

10. Derivatives (continued)

(d) Impact of hedge accounting on the consolidated financial statements

i) Gains(losses) on fair value hedged items and hedging instruments attributable to the hedged ineffectiveness for the years ended December 31, 2021 and 2020 are as follows:

		December 31, 2021		
		Gains on fair value hedges (hedged items)	Losses on fair value hedges (hedging instruments)	Hedge ineffectiveness recognized in profit or loss (*2)
Fair value hedges:				
Interest rate swaps(*1)	₩	273,219	(281,649)	(8,430)
Foreign exchange risk(*1)		26,547	(32,829)	(6,282)
	₩	<u>299,766</u>	<u>(314,478)</u>	<u>(14,712)</u>
		December 31, 2020		
		Losses on fair value hedges (hedged items)	Gains on fair value hedges (hedging instruments)	Hedge ineffectiveness recognized in profit or loss (*2)
Fair value hedges:				
Interest rate swaps(*1)	₩	(228,266)	233,008	4,742
Foreign exchange risk(*1)		(21,336)	12,071	(9,265)
	₩	<u>(249,602)</u>	<u>245,079</u>	<u>(4,523)</u>

(*1) The related account categories are presented as interest rate swap assets / liabilities and currency swap assets.

(*2) Ineffective portion of hedge: the difference between hedging instruments and hedged items.

ii) Due to the ineffectiveness of hedge of cash flow risk and hedge of net investment in foreign operations during the year, the amounts recognized in the income statement and other comprehensive income are as follows:

		December 31, 2021		
		Gains (losses) on hedges recognized in other comprehensive income	Hedge ineffectiveness recognized in profit or loss(*2)	From cash flow hedge reserve to profit or loss reclassified amount
Cash flow hedges:				
Interest rate risk(*1)	₩	15,492	(49,882)	-
Foreign exchange risk(*1)		14,439	(14,955)	24,464
Discontinuation of cash flow hedges		-	-	8,799
Hedge of net investments:				
Foreign exchange risk(*1)		(74,525)	(2,094)	-
	₩	<u>(44,594)</u>	<u>(66,931)</u>	<u>33,263</u>

SHINHAN FINANCIAL GROUP CO., LTD. AND SUBSIDIARIES

Notes to the Consolidated Financial Statements

December 31, 2021 and 2020

(In millions of won)

10. Derivatives (continued)

(d) Impact of hedge accounting on the consolidated financial statements (continued)

ii) Due to the ineffectiveness of hedge of cash flow risk and hedge of net investment in foreign operations during the year, the amounts recognized in the income statement and other comprehensive income are as follows (continued):

	December 31, 2020		
	Gains (losses) on hedges recognized in other comprehensive income	Hedge ineffectiveness recognized in profit or loss(*2)	From cash flow hedge reserve to profit or loss reclassified amount
Cash flow hedges:			
Interest rate risk(*1)	₩ (3,220)	(343)	-
Foreign exchange risk(*1)	(16,693)	(6,539)	26,405
Discontinuation of cash flow hedges	(45)	-	45
Hedge of net investments:			
Foreign exchange risk(*1)	44,049	(2,134)	-
	₩ <u>24,091</u>	<u>(9,016)</u>	<u>26,450</u>

(*1) The related account categories are presented as interest rate swap assets / liabilities and currency swap assets / liabilities, currency forwards assets / liabilities and borrowings.

(*2) Ineffective portion of hedge: The difference between hedging instruments and hedged items.

SHINHAN FINANCIAL GROUP CO., LTD. AND SUBSIDIARIES

Notes to the Consolidated Financial Statements

December 31, 2021 and 2020

(In millions of won)

10. Derivatives (continued)

(e) Effect of hedge accounting on financial statement, statement of comprehensive income, statement of changes in equity

i) Purpose and strategy of risk avoidance

The Group transacts with derivative financial instruments to hedge its interest rate risk and currency risk arising from the assets and liabilities of the Group. The Group applies the fair value hedge accounting for the changes in the market interest rates of the Korean won structured notes, foreign currency generated financial debentures, structured deposits in foreign currencies and foreign currency investment receivables; and cash flow hedge accounting for interest rate swaps and currency swaps to hedge cash flow risk due to interest rates and foreign exchange rates of the Korean won debt, the Korean won bonds, foreign currency bonds, etc. In addition, in order to hedge the exchange rate risk of the net investment in overseas business, the Group applies the net investment hedge accounting for foreign operations using currency forward and non-derivative financial instruments.

ii) Nominal amounts and average hedge ratios for hedging instruments as of December 31, 2021 and 2020 are as follows:

	December 31, 2021						
	Less than 1 year	1~2 years	2~3 years	3~4 years	4~5 years	More than 5 years	Total
Interest risk:							
Nominal values:	₩ 693,057	1,256,392	641,413	158,833	1,589,729	4,356,536	8,695,960
Average price condition(*1)	0.88%	1.21%	1.30%	1.00%	1.00%	0.66%	0.87%
Average hedge ratio:	100%	100%	100%	100%	100%	100%	100%
Exchange risk:(*2)							
Nominal values:	2,328,042	2,164,591	568,991	699,433	480,878	22,525	6,264,460
Average hedge ratio:	100%	100%	100%	100%	100%	100%	100%

(*1) Interest rate swaps consist of 3M CD, 3M USD Libor, 3M Euribor, and 3M AUD Bond.

(*2) The average exchange rates of net investment hedge instruments are USD/KRW 1,143.95, JPY/KRW 10.53, EUR/KRW 1,288.52, GBP/KRW 1,484.00, AUD/KRW 817.06, CAD/KRW 868.95, SGD/KRW 859.87, CNY/KRW 174.40, SEK/KRW 124.85

	December 31, 2020						
	Less than 1 year	1~2 years	2~3 years	3~4 years	4~5 years	More than 5 years	Total
Interest risk:							
Nominal values:	₩ 657,656	640,992	1,217,588	456,688	247,244	4,624,224	7,844,392
Average price condition(*1)	1.12%	0.88%	1.30%	0.98%	0.67%	0.38%	0.67%
Average hedge ratio:	100%	100%	100%	100%	100%	100%	100%
Exchange risk:(*2)							
Nominal values:	2,340,409	1,448,787	1,734,593	457,199	575,527	250,014	6,806,529
Average hedge ratio:	100%	100%	100%	100%	100%	100%	100%

(*1) Interest rate swaps consist of 3M CD, 3M USD Libor, 3M Euribor, and 3M AUD Bond.

(*2) The average exchange rates of net investment hedge instruments are USD/KRW 1,154.76, JPY/KRW 10.61, EUR/KRW 1,287.16, GBP/KRW 1,480.30, AUD/KRW 800.67, CAD/KRW 895.95, SGD/KRW 847.09, CNY/KRW 168.84, SEK/KRW 124.60

SHINHAN FINANCIAL GROUP CO., LTD. AND SUBSIDIARIES

Notes to the Consolidated Financial Statements

December 31, 2021 and 2020

(In millions of won)

10. Derivatives (continued)

(e) Effect of hedge accounting on financial statement, statement of comprehensive income, statement of changes in equity (continued)

iii) Effect of derivatives on statement financial position, statement of comprehensive income, statement of changes in equity

December 31, 2021				
	Nominal amount	Carrying value of asset(*)	Carrying value of liabilities(*)	Changes in fair value in the period
Fair value hedges				
Interest rate swap	₩ 7,079,468	156,710	236,758	(277,450)
Currency forward	176,369	-	4,995	(8,835)
Cash flow hedge				
Interest rate swap	1,616,492	4,687	16,505	23,257
Currency swap	3,726,939	63,560	79,407	156,271
Currency forward	866,129	106	31,486	(63,659)
Hedge of net investments in foreign operations				
Currency forward	237,100	-	9,658	(14,948)
Borrowings	1,257,923	-	1,256,241	(61,672)

(*) The related account categories are presented as interest rate swap assets / liabilities and currency forward assets and liabilities.

December 31, 2020				
	Nominal amount	Carrying value of asset(*)	Carrying value of liabilities(*)	Changes in fair value in the period
Fair value hedges				
Interest rate swap	₩ 6,965,492	319,294	120,728	181,151
Currency swap	-	-	67	985
Currency forward	254,023	20,093	66	24,481
Cash flow hedge				
Interest rate swap	878,900	206	19,118	3,303
Currency swap	4,328,333	65,256	186,083	(8,560)
Currency forward	810,322	60,473	-	(4,181)
Hedge of net investments in foreign operations				
Currency forward	217,600	11,181	10,441	(2,991)
Borrowings	1,196,252	-	1,193,269	44,907

(*) The related account categories are presented as interest rate swap assets / liabilities and currency forward assets and liabilities.

SHINHAN FINANCIAL GROUP CO., LTD. AND SUBSIDIARIES

Notes to the Consolidated Financial Statements

December 31, 2021 and 2020

(In millions of won)

10. Derivatives (continued)

(e) Effect of hedge accounting on financial statement, statement of comprehensive income, statement of changes in equity (continued)

iv) Effect of hedging items on statement financial position, statement of comprehensive income, statement of changes in equity

		December 31, 2021						
		Carrying value of asset(*)	Carrying value of liabilities(*)	Assets of Cumulative fair value hedge adjustment	Liabilities of Cumulative fair value hedge adjustment	Changes if fair value in the year	Cash flow hedge reserve	Foreign currency conversion reserves
Fair value hedges								
Interest rate risk								
Borrowings and others	₩	704,942	6,370,330	6,207	(85,441)	274,005	-	-
Foreign exchange risk								
Securities in foreign currency		415,693	-	-	-	23,109	-	-
Cash flow hedge								
Interest rate risk								
Debentures in won and debentures in foreign currency		607,062	1,714,303	-	-	22,432	67,553	-
Foreign exchange risk								
Debentures in foreign currency and loans in foreign currency		2,848,303	2,782,574	-	-	336,281	(19,296)	-
Hedge of net investments in foreign operations								
Foreign exchange risk								
Net assets in foreign operation		-	-	-	-	74,525	-	(66,626)

(*) The related account categories are presented as interest rate swap assets / liabilities and currency forwards.

		December 31, 2020						
		Carrying value of asset(*)	Carrying value of liabilities(*)	Assets of Cumulative fair value hedge adjustment	Liabilities of Cumulative fair value hedge adjustment	Changes if fair value in the year	Cash flow hedge reserve	Foreign currency conversion reserves
Fair value hedges								
Interest rate risk								
Borrowings and others	₩	143,496	6,750,929	6,563	193,452	(175,369)	-	-
Foreign exchange risk								
Securities in foreign currency		342,205	-	-	-	(26,927)	-	-
Cash flow hedge								
Interest rate risk								
Debentures in won and debentures in foreign currency		617,463	1,674,460	-	-	2,296	60,659	-
Foreign exchange risk								
Debentures in foreign currency and loans in foreign currency		3,264,740	2,962,041	-	-	(58,557)	(32,001)	-
Hedge of net investments in foreign operations								
Foreign exchange risk								
Net assets in foreign business establishment		-	-	-	-	44,049	-	(141,151)

(*) The related account categories are presented as interest rate swap assets / liabilities and currency forwards.

SHINHAN FINANCIAL GROUP CO., LTD. AND SUBSIDIARIES

Notes to the Consolidated Financial Statements

December 31, 2021 and 2020

(In millions of won)

10. Derivatives (continued)

(f) Hedge relationships affected by an interest rate index

The revised Standard requires exceptions to the analysis of future information in relation to the application of hedge accounting, while uncertainty exists due to movements of the interest rate indicator reform. The exception assumes that when assessing whether the expected cash flows that comply with existing interest rate indicators are highly probable, whether there is an economic relationship between the hedged item and the hedging instrument, and whether there is a high hedge effectiveness between the hedged item and the hedging instrument, the interest rate indicators that are based on the hedged item do not change due to the effect of the interest rate index reform. The nominal amount of the hedging instrument related to the interest rate index exposed to the hedging relationship due to the Group's reform of the interest rate index as of December 31, 2021 is as follows:

Interest rate index		Carrying value of hedged item, Assets	Carrying value of hedged item, Liabilities	Nominal amount of hedging instrument
KRW 3M CD (*1)	₩	-	2,509,045	2,580,000
USD 1M LIBOR (*2)		-	241,192	241,842
USD 3M LIBOR(*1),(*2)		539,197	3,589,452	4,187,018
EURIBOR 1M		-	220,992	221,050
EURIBOR 3M		25,094	267,830	293,972
	₩	<u>564,291</u>	<u>6,828,511</u>	<u>7,523,882</u>

(*1) Include nominal amount of the hedging instrument related to the CMS(Constant Maturity Swap) calculated based on the CD and LIBOR rate.

(*2) Exclude the nominal amount that will mature before the end of June 30, 2023, when LIBOR interest rate calculation is discontinued.

The USD LIBOR interest rate will be replaced by a Secured Overnight Financing Rate (SOFR) based on the actual transactions, and the EUR LIBOR interest rate will be replaced by an overnight unsecured rate, Euro Short-Term Rate (ESTER). From November 2021, the "Korea Overnight Financing Repo Rate (KOFRR)" has been calculated and disclosed in line with global interest rate benchmark reform, and it is likely to be used as an alternative rate for CD rates. The Group has assumed that in this hedging relationship, the spread which has changed based on SOFR, ESTER and RFR would be similar to the spreads of interest rate swap and interest rate forward used as the hedging instrument. Besides this, the Group did not make assumptions on further changes of conditions.

SHINHAN FINANCIAL GROUP CO., LTD. AND SUBSIDIARIES

Notes to the Consolidated Financial Statements

December 31, 2021 and 2020

(In millions of won)

11. Securities at fair value through other comprehensive income and securities at amortized cost

(a) Details of securities at FVOCI and securities at amortized cost as of December 31, 2021 and 2020 are as follows:

	<u>December 31, 2021</u>	<u>December 31, 2020</u>
Securities at FVOCI:		
Debt securities:		
Government bonds	₩ 25,687,070	19,370,393
Financial institutions bonds	19,702,292	20,053,716
Corporate bonds and others	18,417,557	17,985,324
	<u>63,806,919</u>	<u>57,409,433</u>
Equity securities(*):		
Stocks	922,579	777,901
Equity investments	4,118	4,445
Others	104,707	124,333
	<u>1,031,404</u>	<u>906,679</u>
	<u>64,838,323</u>	<u>58,316,112</u>
Securities at amortized cost:		
Debt securities:		
Government bonds	34,679,301	31,816,320
Financial institutions bonds	3,423,536	3,835,577
Corporate bonds and others	11,827,239	11,630,726
	<u>49,930,076</u>	<u>47,282,623</u>
	<u>₩ 114,768,399</u>	<u>105,598,735</u>

(*) Equity securities in the above table are classified as other comprehensive income - equity securities designated as fair value items, and other comprehensive income and fair value options are exercised for the purpose of holding as required by the policy.

SHINHAN FINANCIAL GROUP CO., LTD. AND SUBSIDIARIES

Notes to the Consolidated Financial Statements

December 31, 2021 and 2020

(In millions of won)

11. Securities at fair value through other comprehensive income and securities at amortized cost (continued)

(b) Changes in carrying value of debt securities at fair value through other comprehensive income and securities at amortized cost for the years ended December 31, 2021 and 2020 are as follows:

		December 31, 2021					
		Debt securities at fair value through other comprehensive income			Debt securities at amortized cost		
		12-month expected credit loss	Life time expected credit loss	Total	12-month expected credit loss	Life time expected credit loss	Total
Beginning allowance	₩	57,142,298	267,135	57,409,433	47,293,109	-	47,293,109
Transfer (from)to 12-month expected credit loss		51,055	(51,055)	-	-	-	-
Transfer (from)to life time expected credit loss		(35,665)	35,665	-	(35,505)	35,505	-
Net increase and decrease(*)		6,496,445	(98,959)	6,397,486	2,653,129	785	2,653,914
Ending balance	₩	63,654,133	152,786	63,806,919	49,910,733	36,290	49,947,023

(*) Included the effects from changes in purchase, disposal, repayment, foreign exchange rate, amortization of fair value adjustments recognized through business combination accountings.

SHINHAN FINANCIAL GROUP CO., LTD. AND SUBSIDIARIES

Notes to the Consolidated Financial Statements

December 31, 2021 and 2020

(In millions of won)

11. Securities at fair value through other comprehensive income and securities at amortized cost (continued)

(b) Changes in carrying value of debt securities at fair value through other comprehensive income and securities at amortized cost for the years ended December 31, 2021 and 2020 are as follows (continued):

	December 31, 2020					
	Debt securities at fair value through other comprehensive income			Debt at amortized cost		
	12-month expected credit loss	Life time expected credit loss	Total	12-month expected credit loss	Life time expected credit loss	Total
Beginning allowance	₩ 58,334,000	239,094	58,573,094	45,568,563	23,272	45,591,835
Transfer (from)to 12-month expected credit loss	30,233	(30,233)	-	-	-	-
Transfer (from)to life time expected credit loss	(83,132)	83,132	-	-	-	-
Net increase and decrease(*)	(1,138,803)	(24,858)	(1,163,661)	1,724,546	(23,272)	1,701,274
Ending balance	₩ 57,142,298	267,135	57,409,433	47,293,109	-	47,293,109

(*) Included the effects from changes in purchase, disposal, repayment, foreign exchange rate, amortization of fair value adjustments recognized through business combination accountings.

SHINHAN FINANCIAL GROUP CO., LTD. AND SUBSIDIARIES

Notes to the Consolidated Financial Statements

December 31, 2021 and 2020

(In millions of won)

11. Securities at fair value through other comprehensive income and securities at amortized cost (continued)

(c) Changes in allowance for credit loss of debt securities at fair value through other comprehensive income and securities at amortized cost for the years ended December 31, 2021 and 2020 are as follows:

	December 31, 2021					
	Debt securities at fair value through other comprehensive income			Debt securities at amortized cost		
	12 months expected credit loss	Life time expected credit loss	Total	12 months expected credit loss	Life time expected credit loss	Total
Beginning allowance	₩ 22,493	678	23,171	10,486	-	10,486
Transfer (from)to 12-month expected credit loss	33	(33)	-	-	-	-
Transfer (from)to life time expected credit loss	(63)	63	-	(216)	216	-
Provision (reversal)	19,722	(25)	19,697	5,065	240	5,305
Disposal and others(*)	(5,302)	(80)	(5,382)	1,149	7	1,156
Ending balance	₩ 36,883	603	37,486	16,484	463	16,947

(*) Included the effects from changes in foreign exchange rate, debt restructuring, investment conversion.

SHINHAN FINANCIAL GROUP CO., LTD. AND SUBSIDIARIES

Notes to the Consolidated Financial Statements

December 31, 2021 and 2020

(In millions of won)

11. Securities at fair value through other comprehensive income and securities at amortized cost (continued)

(c) Changes in allowance for credit loss of debt securities at fair value through other comprehensive income and securities at amortized cost for the years ended December 31, 2021 and 2020 are as follows:

	December 31, 2020					
	Debt securities at fair value through other comprehensive income			Debt securities at amortized cost		
	12 months expected credit loss	Life time expected credit loss	Total	12 months expected credit loss	Life time expected credit loss	Total
Beginning allowance	₩ 27,581	655	28,236	9,759	11	9,770
Transfer (from)to 12-month expected credit loss	22	(22)	-	-	-	-
Transfer (from)to life time expected credit loss	(193)	193	-	-	-	-
Provision (reversal)	3,480	349	3,829	1,086	(11)	1,075
Disposal and others(*)	(8,397)	(497)	(8,894)	(359)	-	(359)
Ending balance	₩ 22,493	678	23,171	10,486	-	10,486

(*) Included the effects from changes in foreign exchange rate, debt restructuring, investment conversion.

SHINHAN FINANCIAL GROUP CO., LTD. AND SUBSIDIARIES

Notes to the Consolidated Financial Statements

December 31, 2021 and 2020

(In millions of won)

11. Securities at fair value through other comprehensive income and securities at amortized cost (continued)

(d) Gain or loss on disposal of securities at fair value through other comprehensive income and securities at amortized cost for the years ended December 31, 2021 and 2020 are as follows:

	<u>December 31, 2021</u>	<u>December 31, 2020</u>
Gain on disposal of securities at FVOCI	₩ 131,189	301,920
Loss on disposal of securities at FVOCI	(45,593)	(28,127)
Gain on disposal of securities at amortized cost(*)	24	42
Loss on disposal of securities at amortized cost(*)	(343)	(67)
	<u>₩ 85,277</u>	<u>273,768</u>

(*) The issuers of those securities have exercised the early redemption options and the others.

(e) Income or loss on equity securities at fair value through other comprehensive income

i) The Group recognizes dividends, amounting to ₩24,216 million and ₩21,503 million, related to equity securities at fair value through other comprehensive income for the years ended December 31, 2021 and 2020, respectively.

ii) The details of disposal of equity securities at fair value through other comprehensive income for the years ended December 31, 2021 and 2020 are as follows:

	<u>December 31, 2021</u>	<u>December 31, 2020</u>
	Stocks acquired by investment conversion	
Fair value at the date of disposal	₩ 84,624	69,969
Cumulative net gain at the time of disposal	(42,058)	(38,380)

(*) The reason for the disposal is the disposal of stocks acquired by investment conversion.

SHINHAN FINANCIAL GROUP CO., LTD. AND SUBSIDIARIES

Notes to the Consolidated Financial Statements

December 31, 2021 and 2020

(In millions of won)

12. Loans at amortized cost, etc.

(a) Loans at amortized cost for configuration by customer as of December 31, 2021 and 2020 are as follows:

	December 31, 2021	December 31, 2020
Retail loans	₩ 159,006,999	146,789,916
Corporate loans	199,465,807	179,011,251
Public and other loans	3,468,917	3,734,629
Loans between banks	3,849,565	5,492,400
Credit card receivables	25,999,576	23,759,422
	<u>391,790,864</u>	<u>358,787,618</u>
Discount	(30,001)	(21,948)
Deferred loan origination costs	543,361	516,815
	<u>392,304,224</u>	<u>359,282,485</u>
Less: Allowance for credit loss	(3,167,068)	(3,060,966)
	<u>₩ 389,137,156</u>	<u>356,221,519</u>

SHINHAN FINANCIAL GROUP CO., LTD. AND SUBSIDIARIES

Notes to the Consolidated Financial Statements

December 31, 2021 and 2020

(In millions of won)

12. Loans at amortized cost, etc. (continued)

(b) Changes in carrying value of loans at amortized cost, etc. as of December 31, 2021 and 2020 are as follows:

i) *Loans at amortized cost*

	December 31, 2021													Total
	Retail			Corporate			Credit card			Others				
	12 months expected credit loss	Life time expected credit loss	Impaired financial asset	12 months expected credit loss	Life time expected credit loss	Impaired financial asset	12 months expected credit loss	Life time expected credit loss	Impaired financial asset	12 months expected credit loss	Life time expected credit loss	Impaired financial asset		
Beginning balance	₩ 138,516,630	8,215,137	466,427	152,338,024	26,210,417	1,057,932	18,969,258	3,951,689	468,377	8,405,173	665,196	18,225	359,282,485	
Transfer (from) to 12 months expected credit losses	3,200,712	(3,192,315)	(8,397)	6,566,663	(6,494,160)	(72,503)	390,658	(390,593)	(65)	43,343	(43,343)	-	-	
Transfer (from) to lifetime expected credit losses	(3,482,541)	3,516,278	(33,737)	(9,636,590)	9,659,114	(22,524)	(674,961)	675,063	(102)	(94,270)	94,272	(2)	-	
Transfer (from) to credit- impaired financial assets	(194,192)	(134,008)	328,200	(230,972)	(322,361)	553,333	(110,704)	(158,036)	268,740	(896)	(2)	898	-	
Net increase and decrease(*1)	12,821,174	(255,318)	38,153	20,922,205	(222,364)	(146,801)	2,772,167	88,680	287,576	(1,810,906)	(47,466)	(108)	34,446,992	
Charge off(*2)	-	-	(279,789)	-	-	(299,661)	-	-	(566,944)	-	-	(1,218)	(1,147,612)	
Disposal	-	(724)	(53,241)	(84,433)	(180)	(139,019)	-	-	-	-	-	(44)	(277,641)	
Ending balance	₩ 150,861,783	8,149,050	457,616	169,874,897	28,830,466	930,757	21,346,418	4,166,803	457,582	6,542,444	668,657	17,751	392,304,224	

(*1) The amount is due to execution, collection, debt restructuring, investment conversion, exchange rate fluctuation, etc.

(*2) The amount of uncollected loans currently in recovery (principal and interest) is ₩10,613,730 million, which is written off as of December 31, 2021.

SHINHAN FINANCIAL GROUP CO., LTD. AND SUBSIDIARIES

Notes to the Consolidated Financial Statements

December 31, 2021 and 2020

(In millions of won)

12. Loans at amortized cost, etc. (continued)

(b) Changes in carrying value of loans at amortized cost, etc. as of December 31, 2021 and 2020 are as follows (continued):

ii) *Due from banks at amortized cost and other financial assets*

	December 31, 2021			
	12 month expected credit loss	Life time expected credit loss	Impaired financial asset	Total
Beginning balance	₩ 51,881,798	99,899	57,658	52,039,355
Transfer (from) to 12 month expected credit losses	13,111	(13,079)	(32)	-
Transfer (from) to lifetime expected credit losses	(29,026)	29,048	(22)	-
Transfer (from) to credit- impaired financial assets	(1,049)	(11,797)	12,846	-
Net increase and decrease(*)	(4,315,675)	580	37,428	(4,277,667)
Charge off	-	-	(27,929)	(27,929)
Disposal	-	(1)	(855)	(856)
Ending balance	₩ 47,549,159	104,650	79,094	47,732,903

(*) The amount is due to execution, collection, debt restructuring, investment conversion, exchange rate fluctuation, etc.

SHINHAN FINANCIAL GROUP CO., LTD. AND SUBSIDIARIES

Notes to the Consolidated Financial Statements

December 31, 2021 and 2020

(In millions of won)

12. Loans at amortized cost, etc. (continued)

(b) Changes in carrying value of loans at amortized cost, etc. as of December 31, 2021 and 2020 are as follows (continued):

i) Loans at amortized cost (continued)

	December 31, 2020													Total
	Retail			Corporate			Credit card			Others				
	12 months expected credit loss	Life time expected credit loss	Impaired financial asset	12 months expected credit loss	Life time expected credit loss	Impaired financial asset	12 months expected credit loss	Life time expected credit loss	Impaired financial asset	12 months expected credit loss	Life time expected credit loss	Impaired financial asset		
Beginning balance	₩ 126,586,551	7,870,908	415,892	135,591,673	24,661,662	1,001,587	19,419,606	4,124,576	444,235	5,167,393	629,468	16,263	325,929,814	
Transfer (from) to 12 months expected credit losses	2,891,847	(2,885,809)	(6,038)	6,009,242	(6,006,226)	(3,016)	351,253	(350,651)	(602)	15,976	(15,976)	-	-	
Transfer (from) to lifetime expected credit losses	(3,916,612)	3,944,714	(28,102)	(9,015,428)	9,027,416	(11,988)	(571,971)	572,291	(320)	(85,337)	85,337	-	-	
Transfer (from) to credit- impaired financial assets	(189,681)	(157,637)	347,318	(195,863)	(441,969)	637,832	(114,388)	(191,777)	306,165	(3,964)	(37)	4,001	-	
Net increase and decrease(*1)	13,457,675	(556,142)	81,131	20,679,401	(1,030,466)	15,944	(115,242)	(202,750)	290,907	3,311,105	(33,596)	2,402	35,900,369	
Charge off(*2)	-	-	(254,723)	-	-	(317,514)	-	-	(572,008)	-	-	(2,531)	(1,146,776)	
Disposal	(313,150)	(897)	(89,051)	(731,001)	-	(264,913)	-	-	-	-	-	(1,910)	(1,400,922)	
Ending balance	₩ 138,516,630	8,215,137	466,427	152,338,024	26,210,417	1,057,932	18,969,258	3,951,689	468,377	8,405,173	665,196	18,225	359,282,485	

(*1) The amount is due to execution, collection, debt restructuring, investment conversion, exchange rate fluctuation, etc.

(*2) The amount of uncollected loans currently in recovery (principal and interest) is ₩10,436,407 million, which is written off as of December 31, 2020.

SHINHAN FINANCIAL GROUP CO., LTD. AND SUBSIDIARIES

Notes to the Consolidated Financial Statements

December 31, 2021 and 2020

(In millions of won)

12. Loans at amortized cost, etc. (continued)

(b) Changes in carrying value of loans at amortized cost, etc. as of December 31, 2021 and 2020 are as follows (continued):

ii) Due from banks at amortized cost and other financial assets (continued)

	December 31, 2020			
	12 month expected credit loss	Life time expected credit loss	Impaired financial asset	Total
Beginning balance	₩ 43,245,002	106,517	45,965	43,397,484
Transfer (from) to 12 month expected credit losses	15,157	(15,123)	(34)	-
Transfer (from) to lifetime expected credit losses	(25,839)	25,848	(9)	-
Transfer (from) to credit- impaired financial assets	(1,628)	(7,342)	8,970	-
Net increase and decrease(*)	8,633,124	(10,001)	30,490	8,653,613
Charge off	-	-	(26,814)	(26,814)
Disposal	-	-	(910)	(910)
Business combination(Note 47)	15,982	-	-	15,982
Ending balance	₩ 51,881,798	99,899	57,658	52,039,355

(*) The amount is due to execution, collection, debt restructuring, investment conversion, exchange rate fluctuation, etc.

SHINHAN FINANCIAL GROUP CO., LTD. AND SUBSIDIARIES

Notes to the Consolidated Financial Statements

December 31, 2021 and 2020

(In millions of won)

12. Loans at amortized cost, etc. (continued)

(c) Changes in allowance for credit loss of loans at amortized cost and other financial assets as of December 31, 2021 and 2020 are as follows:

i) *Loans at amortized cost*

		December 31, 2021												
		Retail			Corporate			Credit cards			Others			
		12 month expected credit loss	Life time expected credit loss	Impaired financial asset	12 month expected credit loss	Life time expected credit loss	Impaired financial asset	12 month expected credit loss	Life time expected credit loss	Impaired financial asset	12 month expected credit loss	Life time expected credit loss	Impaired financial asset	Total
Beginning balance	₩	149,034	86,048	198,440	568,614	665,083	481,244	203,908	374,453	306,690	11,434	9,601	6,417	3,060,966
Transfer (from) to 12 months expected credit losses		20,528	(19,794)	(734)	85,187	(79,571)	(5,616)	26,178	(26,149)	(29)	200	(200)	-	-
Transfer (from) to lifetime expected credit losses		(9,078)	21,383	(12,305)	(55,055)	63,834	(8,779)	(14,471)	14,548	(77)	(359)	359	-	-
Transfer (from) to credit- impaired financial assets		(3,203)	(7,112)	10,315	(1,830)	(48,468)	50,298	(1,003)	(1,503)	2,506	(7)	-	7	-
Provision (reversal)		10,812	(1,321)	154,260	(68,403)	135,401	263,327	75,981	202,000	137,456	(1,342)	(503)	(598)	907,070
Charge off		-	-	(279,789)	-	-	(299,661)	-	-	(566,944)	-	-	(1,218)	(1,147,612)
Amortization of discount		-	-	(4,651)	-	-	(12,894)	-	-	7,973	-	-	-	(9,572)
Disposal		-	(1)	(13,617)	(6)	-	(14,528)	-	-	-	-	-	(1)	(28,153)
Collection		-	-	103,316	-	-	76,245	-	-	207,631	-	-	887	388,079
Others(*)		5,912	11,209	34,571	1,793	5,973	(9,310)	(85,882)	(162,272)	194,026	269	1	-	(3,710)
Ending balance	₩	174,005	90,412	189,806	530,300	742,252	520,326	204,711	401,077	289,232	10,195	9,258	5,494	3,167,068

(*) Other changes are due to debt restructuring, investment conversion and changes in foreign exchange rate.

SHINHAN FINANCIAL GROUP CO., LTD. AND SUBSIDIARIES

Notes to the Consolidated Financial Statements

December 31, 2021 and 2020

(In millions of won)

12. Loans at amortized cost, etc. (continued)

(c) Changes in allowance for credit loss of loans at amortized cost and other financial assets as of December 31, 2021 and 2020 are as follows (continued):

ii) *Due from banks at amortized cost and other financial assets*

	December 31, 2021			
	12 months expected credit loss	Life time expected credit loss	Impaired financial asset	Total
Beginning balance	₩ 35,691	8,281	48,930	92,902
Transfer (from) to 12 months expected credit losses	241	(230)	(11)	-
Transfer (from) to lifetime expected credit losses	(284)	288	(4)	-
Transfer (from) to credit- impaired financial assets	(290)	(2,012)	2,302	-
Provision (reversal)	8,555	1,426	42,181	52,162
Charge off	-	-	(27,929)	(27,929)
Disposal	-	-	(40)	(40)
Collection	-	-	2,357	2,357
Others (*2)	139,995	255	2,257	142,507
Ending balance	₩ 183,908	8,008	70,043	261,959

(*1) It includes allowances for expected credit losses of deposits at amortized cost and other financial assets.

(*2) Other changes are due to debt restructuring, investment conversion and changes in foreign exchange rate.

SHINHAN FINANCIAL GROUP CO., LTD. AND SUBSIDIARIES

Notes to the Consolidated Financial Statements

December 31, 2021 and 2020

(In millions of won)

12. Loans at amortized cost, etc. (continued)

(c) Changes in allowance for credit loss of loans at amortized cost and other financial assets as of December 31, 2021 and 2020 are as follows (continued):

i) *Loans at amortized cost*

		December 31, 2020												
		Retail			Corporate			Credit cards			Others			
		12 month expected credit loss	Life time expected credit loss	Impaired financial asset	12 month expected credit loss	Life time expected credit loss	Impaired financial asset	12 month expected credit loss	Life time expected credit loss	Impaired financial asset	12 month expected credit loss	Life time expected credit loss	Impaired financial asset	Total
Beginning balance	₩	133,412	91,025	169,038	419,752	531,286	469,207	173,884	365,248	314,850	7,501	7,481	2,151	2,684,835
Transfer (from) to 12 months expected credit losses		20,082	(19,487)	(595)	67,590	(66,777)	(813)	22,148	(21,591)	(557)	164	(164)	-	-
Transfer (from) to lifetime expected credit losses		(9,077)	18,772	(9,695)	(49,727)	55,512	(5,785)	(11,568)	11,834	(266)	(242)	242	-	-
Transfer (from) to credit- impaired financial assets		(3,247)	(9,010)	12,257	(1,590)	(52,383)	53,973	(901)	(2,041)	2,942	(13)	(9)	22	-
Provision (reversal)		5,253	(5,319)	199,765	149,400	211,341	265,557	103,793	210,592	137,254	4,188	2,048	6,823	1,290,695
Charge off		-	-	(254,723)	-	-	(317,514)	-	-	(572,008)	-	-	(2,531)	(1,146,776)
Amortization of discount		-	-	(5,630)	-	-	(15,151)	-	-	(7,807)	-	-	-	(28,588)
Disposal		(343)	(8)	(18,605)	(726)	-	(24,473)	-	-	-	-	-	(182)	(44,337)
Collection		-	-	85,819	-	-	63,822	-	-	200,234	-	-	134	350,009
Others (*)		2,954	10,075	20,809	(16,085)	(13,896)	(7,579)	(83,448)	(189,589)	232,048	(164)	3	-	(44,872)
Ending balance	₩	149,034	86,048	198,440	568,614	665,083	481,244	203,908	374,453	306,690	11,434	9,601	6,417	3,060,966

(*) Other changes are due to debt restructuring, investment conversion and changes in foreign exchange rate.

SHINHAN FINANCIAL GROUP CO., LTD. AND SUBSIDIARIES

Notes to the Consolidated Financial Statements

December 31, 2021 and 2020

(In millions of won)

12. Loans at amortized cost, etc. (continued)

(c) Changes in allowance for credit loss of loans at amortized cost and other financial assets as of December 31, 2021 and 2020 are as follows (continued):

ii) *Due from banks at amortized cost and other financial assets*

	December 31, 2020			
	12 months expected credit loss	Life time expected credit loss	Impaired financial asset	Total
Beginning balance	₩ 33,987	7,272	37,590	78,849
Transfer (from) to 12 months expected credit losses	286	(273)	(13)	-
Transfer (from) to lifetime expected credit losses	(259)	264	(5)	-
Transfer (from) to credit-impaired financial assets	(256)	(1,492)	1,748	-
Provision (reversal)	(2,143)	2,650	33,278	33,785
Charge off	-	-	(26,814)	(26,814)
Disposal	(2)	-	(32)	(34)
Collection	-	-	2,166	2,166
Others (*2)	4,078	(140)	1,012	4,950
Ending balance	₩ <u>35,691</u>	<u>8,281</u>	<u>48,930</u>	<u>92,902</u>

(*1) It includes allowances for expected credit losses of deposits at amortized cost and other financial assets.

(*2) Other changes are due to debt restructuring, investment conversion and changes in foreign exchange rate.

(d) Changes in deferred loan origination costs for the years ended December 31, 2021 and 2020 are as follows:

	December 31, 2021	December 31, 2020
Beginning balance	₩ 516,815	534,530
Loan origination	255,482	257,034
Amortization, etc.	(228,936)	(274,749)
Ending balance	₩ <u>543,361</u>	<u>516,815</u>

SHINHAN FINANCIAL GROUP CO., LTD. AND SUBSIDIARIES

Notes to the Consolidated Financial Statements

December 31, 2021 and 2020

(In millions of won)

13. Property and equipment

(a) Details of property and equipment as of December 31, 2021 and 2020 are as follows:

December 31, 2021				
	Acquisition cost	Accumulated depreciation	Accumulated Impairment	Carrying value
Land	₩ 2,173,134	-	-	2,173,134
Buildings	1,210,401	(446,321)	(7,594)	756,486
Right-of-use assets	1,229,169	(621,042)	-	608,127
Other assets	2,294,740	(1,786,323)	-	508,417
	₩ 6,907,444	(2,853,686)	(7,594)	4,046,164

December 31, 2020				
	Acquisition cost	Accumulated depreciation	Carrying value	
Land	₩ 2,219,227	-	2,219,227	
Buildings	1,230,187	(419,426)	810,761	
Right-of-use assets	1,016,183	(425,766)	590,417	
Other assets	2,197,485	(1,828,193)	369,292	
	₩ 6,663,082	(2,673,385)	3,989,697	

(b) Changes in property and equipment for the years ended December 31, 2021 and 2020 are as follows:

December 31, 2021					
	Land	Buildings	Right-of-use assets	Others	Total
Beginning balance	₩ 2,219,227	810,761	590,417	369,292	3,989,697
Acquisition(*1)	513	32,777	316,925	289,614	639,829
Disposal	(709)	(1,378)	(26,930)	(5,086)	(34,103)
Depreciation(*2)	-	(49,646)	(289,585)	(154,104)	(493,335)
Impairment	-	(7,594)	-	-	(7,594)
Amounts transferred from(to) investment property	(46,046)	(27,727)	-	-	(73,773)
Amounts transferred from(to) intangible assets	-	-	-	3,676	3,676
Amounts transferred from(to) non-current assets held for sale(*3)	(169)	(853)	-	-	(1,022)
Effects of foreign currency adjustments	318	146	17,300	5,025	22,789
Ending balance	₩ 2,173,134	756,486	608,127	508,417	4,046,164

(*1) ₩18,748 million transferred from assets-under-construction is included.

(*2) Included in general administrative expense and other operating income(loss) of the consolidated statements of comprehensive income.

(*3) Includes buildings, land, etc.

SHINHAN FINANCIAL GROUP CO., LTD. AND SUBSIDIARIES

Notes to the Consolidated Financial Statements

December 31, 2021 and 2020

(In millions of won)

13. Property and equipment (continued)

(b) Changes in property and equipment for the years ended December 31, 2021 and 2020 are as follows (continued):

		December 31, 2020				
		Land	Buildings	Right-of-use assets	Others	Total
Beginning balance	₩	1,815,112	790,449	1,112,796	364,971	4,083,328
Acquisition(*1)		78,066	56,828	305,958	140,958	581,810
Disposal		(92,683)	(46,897)	(24,173)	(2,398)	(166,151)
Depreciation		-	(56,041)	(286,028)	(133,437)	(475,506)
Amounts transferred from(to) investment property		55,316	(51,252)	-	-	4,064
Amounts transferred from(to) intangible assets		-	-	-	3,738	3,738
Amounts transferred from(to) non-current assets held for sale(*2)		(31,622)	(11)	-	-	(31,633)
Amounts transferred from(to) right-of-use assets		395,346	118,091	(513,437)	-	-
Others		-	-	-	(2,235)	(2,235)
Effects of foreign currency adjustments		(308)	(406)	(5,380)	(2,459)	(8,553)
Business combination (Note 47)		-	-	681	154	835
Ending balance	₩	<u>2,219,227</u>	<u>810,761</u>	<u>590,417</u>	<u>369,292</u>	<u>3,989,697</u>

(*1) ₩56,575 million transferred from assets-under-construction is included.

(*2) Includes buildings, land, etc.

(c) Insured assets and liability insurance as of December 31, 2021 are as follows:

Type of insurance	Insured assets and objects	December 31, 2021	
		Amount covered	Insurance company
Comprehensive insurance for financial institutions	Cash(including ATM)	25,500	Samsung Fire & Marine Insurance Co., Ltd., etc.
Comprehensive Property insurance	Property Total Risk, Machine Risk, General Liability Collateral	1,920,218	Samsung Fire & Marine Insurance Co., Ltd., etc.
Fire insurance	Business property and real estate	26,164	Meritz Fire & Marine Insurance Co., Ltd., etc.
Compensation liability insurance for officers	Officer liability of executives	50,000	Meritz Fire & Marine Insurance Co., Ltd., etc.
Compensation liability insurance for employee accident	Employee	79,798	Meritz Fire & Marine Insurance Co., Ltd., etc.
Burglary insurance	Cash and securities	79,755	Samsung Fire & Marine Insurance Co., Ltd., etc.
Others	Personal information liability insurance etc.	33,478	Samsung Fire & Marine Insurance Co., Ltd., etc.

(*) Aside from the insurance mentioned above, the Group has entered into car insurance, medical insurance, and property insurance.

SHINHAN FINANCIAL GROUP CO., LTD. AND SUBSIDIARIES

Notes to the Consolidated Financial Statements

December 31, 2021 and 2020

(In millions of won)

14. Intangible assets

(a) Details of intangible assets as of December 31, 2021 and 2020 are as follows:

		<u>December 31, 2021</u>	<u>December 31, 2020</u>
Goodwill	₩	4,670,134	4,689,792
Software		192,582	144,535
Development cost		229,148	183,592
Others		552,918	462,700
	₩	<u>5,644,782</u>	<u>5,480,619</u>

(b) Changes in intangible assets for the years ended December 31, 2021 and 2020 are as follows:

		<u>December 31, 2021</u>				
		<u>Goodwill</u>	<u>Software</u>	<u>Development cost</u>	<u>Others</u>	<u>Total</u>
Beginning balance	₩	4,689,792	144,535	183,592	462,700	5,480,619
Acquisition		-	103,929	127,993	225,228	457,150
Disposal and Write-off		-	(2,341)	(719)	(5,349)	(8,409)
Amounts transferred from(to) property and equipment		-	-	(3,676)	-	(3,676)
Impairment(*1)		(33,509)	-	(270)	(765)	(34,544)
Amortization(*2)		-	(55,531)	(77,734)	(129,615)	(262,880)
Effects of changes in foreign exchange rate		-	1,990	(38)	719	2,671
Business combination (Note 47)		13,851	-	-	-	13,851
Ending balance	₩	<u>4,670,134</u>	<u>192,582</u>	<u>229,148</u>	<u>552,918</u>	<u>5,644,782</u>

(*1) Goodwill impairment has occurred at Shinhan Bank Indonesia within the banking sector and PT Shinhan Sekuritas Indonesia within the securities sector among the cash-generating units. After the impairment test for goodwill of Shinhan Bank Indonesia, among the carrying value exceeding recoverable amount of cash-generating unit, which is ₩32,396 million, the Group has recognized ₩32,072 million as an impairment of goodwill which is 99% of the Group's total stake. After the impairment test for goodwill of PT Shinhan Sekuritas Indonesia, among the carrying value exceeding recoverable amount of cash-generating unit, which is ₩2,595 million, the Group has recognized ₩2,569 million as an impairment of goodwill which is 99% of the Group's total stake. This has occurred as a result of the persistent low-interest rate in Indonesia, the impact of COVID-19, and the decrease in the recoverable amount due to increased provisions of corporate borrowers. For the year ended December 31, 2021, the decrease in the asset's recoverable amount in comparison to the previous year is ₩56,587 million and ₩8,715 million, respectively. The amount of goodwill impairment recognized is included in the non-operating expenses of the consolidated statement of comprehensive income.

(*2) Included in general administrative expense and other operating income(expense) of the consolidated statements of comprehensive income.

SHINHAN FINANCIAL GROUP CO., LTD. AND SUBSIDIARIES

Notes to the Consolidated Financial Statements

December 31, 2021 and 2020

(In millions of won)

14. Intangible assets

(b) Changes in intangible assets for the years ended December 31, 2021 and 2020 are as follows (continued):

	December 31, 2020				
	Goodwill	Software	Development cost	Others	Total
Beginning balance	₩ 4,690,049	129,235	144,100	595,330	5,558,714
Acquisition	-	64,195	105,101	64,079	233,375
Disposal and Write-off	-	(1)	(75)	(26,785)	(26,861)
Amounts transferred from(to) property and equipment	-	1,415	(7,820)	2,667	(3,738)
Impairment(*1)(*2)	(14,235)	-	-	(27,075)	(41,310)
Amortization(*3)	-	(49,159)	(57,690)	(145,756)	(252,605)
Effects of changes in foreign exchange rates	-	(1,150)	(24)	(222)	(1,396)
Business combination (Note 47)	13,978	-	-	462	14,440
Ending balance	₩ <u>4,689,792</u>	<u>144,535</u>	<u>183,592</u>	<u>462,700</u>	<u>5,480,619</u>

(*1) The number of customer contacts decreased due to the decrease in the base interest rate in Indonesia in 2020 and the impact of COVID-19. Therefore, reclaimable amount decreased due to reduced loan and increased provisioning by corporate borrowers. PT Bank Shinhan Indonesia's CGUs can recover ₩ 409,968 million. The carrying value exceeding the recoverable amount of PT Bank Shinhan Indonesia's CGUs is ₩ 14,379 million. The Group recognized as impairment losses of ₩ 14,235 million based on the 99% stake the Group owns.

(*2) The Group reviewed the recoverable value of intangible assets related to the rights to be the depository bank of local governments due to the performance below forecast and future prospects. For the year ended December 31, 2020, the impairment loss amounted to ₩27,133 million. The impairment loss is included in the non-operating expenses in the consolidated statement of comprehensive income.

(*3) Included in general administrative expense and other operating income(expense) of the consolidated statements of comprehensive income.

SHINHAN FINANCIAL GROUP CO., LTD. AND SUBSIDIARIES

Notes to the Consolidated Financial Statements

December 31, 2021 and 2020

(In millions of won)

14. Intangible asset (continued)

(c) Goodwill

i) Goodwill allocated in the Group's CGUs as of December 31, 2021 and 2020

	<u>December 31, 2021</u>	<u>December 31, 2020</u>
Banking	₩ 764,883	795,823
Credit card	2,880,383	2,880,383
Securities	5,335	7,904
Life insurance	853,798	839,947
Others	165,735	165,735
	<u>₩ 4,670,134</u>	<u>4,689,792</u>

ii) Changes in goodwill for the years ended December 31, 2021 and 2020

	<u>December 31, 2021</u>	<u>December 31, 2020</u>
Beginning balance	₩ 4,689,792	4,690,049
Acquisitions through business combinations (*1)(*2)	13,851	13,978
Impairment losses	(33,509)	(14,235)
Ending balance	<u>₩ 4,670,134</u>	<u>4,689,792</u>

(*1) It is the goodwill recognized by Shinhan Financial Plus, a subsidiary acquired in the period, from a business transfer for the GF division and IMGA division of Leaders Financial Marketing (Note 47).

(*2) It is the goodwill recognized by the Group as it newly acquired the Shinhan Venture Investment Co., Ltd. for the year ended December 31, 2020 (Note 47).

iii) Goodwill impairment test

The recoverable amounts of each CGU are evaluated based on their respective value in use.

- Explanation on evaluation method

The income approach is applied when evaluating the recoverable amounts based on value in use, considering the characteristics of each unit or group of CGU.

- Projection period

When evaluating the value in use, 4.5 years ~5.5 years of cash flow estimates are used in projection and the value thereafter is reflected as terminal value. 99 years of cash flow estimates for Shinhan Life Insurance Co., Ltd. is applied and the present value of the future cash flows thereafter is not applied as it is not significant.

SHINHAN FINANCIAL GROUP CO., LTD. AND SUBSIDIARIES

Notes to the Consolidated Financial Statements

December 31, 2021 and 2020

(In millions of won)

14. Intangible assets, net (continued)

- Discount rates and terminal growth rates

The required rates of return expected by shareholders are applied to the discount rates. It is calculated in consideration of which comprises a risk-free interest rate, a market risk premium and systemic risk (beta factor). In addition, terminal growth rate is estimated based on inflation rate.

Discount rates and terminal growth rates applied to each CGU are as follows:

	<u>Discount rate(%)</u>	<u>Terminal growth rate(%)</u>
Banking	9.7 ~ 12.1	1.0 ~ 2.0
Credit card	9.3 ~ 11.8	1.0 ~ 2.0
Securities	11.6 ~ 12.6	2.0
Life insurance	7.5 ~ 12.7	-
Others	10.8 ~ 14.9	1.0

iv) Key assumptions

Key assumptions used in the discounted cash flow calculations of CGUs (other than life insurance components) are as follows:

	<u>2021</u>	<u>2022</u>	<u>2023</u>	<u>2024</u>	<u>2025</u>	<u>2026</u>
CPI growth(%)	2.2	1.7	1.4	1.7	1.5	1.5
Private consumption growth(%)	3.1	2.6	2.5	2.7	2.6	2.6
Real GDP growth(%)	3.8	2.7	2.5	3.0	2.8	2.8

Key assumptions used in the discounted cash flow calculations of life insurance (Shinhan life insurance) components are as follows:

	<u>Key assumptions</u>
Rate of return on investment(%)	3.1
Risk-based capital ratio(%)	150.0

v) Total recoverable amount and total carrying value of CGUs to which goodwill has been allocated, are as follows:

	<u>Amount</u>
Total recoverable amount	₩ 51,932,888
Total carrying value(*1)	45,482,263
	₩ <u>6,450,625</u>

(*1) It is the carrying value after reflecting the impairment loss in the banking and securities sector.

SHINHAN FINANCIAL GROUP CO., LTD. AND SUBSIDIARIES

Notes to the Consolidated Financial Statements

December 31, 2021 and 2020

(In millions of won)

15. Investments in associates

(a) Investments in associates as of December 31, 2021 and 2020 are as follows:

Investees	Country	Reporting date	Ownership (%)	
			December 31, 2021	December 31, 2020
BNP Paribas Cardif Life Insurance (*1)(*2)	Korea	September 30	14.99	14.99
Songrim Partners (*3)(*4)	Korea	December 31	35.34	35.34
Partners 4th Growth Investment Fund (*1)	Korea	September 30	25.00	25.00
KTB Newlake Global Healthcare PEF (*1)	Korea	September 30	30.00	30.00
Daekwang Semiconductor Co., Ltd. (*7)	Korea	-	-	20.94
Shinhan-Neoplux Energy Newbiz Fund(*5)	Korea	December 31	31.66	31.66
Shinhan-Albatross tech investment Fund(*5)	Korea	December 31	50.00	49.97
VOGO Debt Strategy Qualified IV Private	Korea	December 31	20.00	20.00
Shinhan-Midas Donga Secondary Fund(*6)	Korea	December 31	50.00	50.00
ShinHan – Soo Young Entrepreneur Investment Fund No.1	Korea	December 31	24.00	24.00
Shinhan Praxis K-Growth Global Private Equity Fund(*9)	Korea	December 31	18.87	18.87
Credian Healthcare Private Equity Fund II(*7)	Korea	-	-	34.07
Kiwoom Milestone Professional Private Real Estate Trust 19	Korea	December 31	50.00	50.00
AIP EURO Green Private Real Estate Trust No.3	Korea	December 31	21.28	21.28
Shinhan Global Healthcare Fund 1(*9)	Korea	December 31	4.41	4.41
JB Power TL Investment Type Private Placement Special Asset Fund 7(*7)	Korea	-	-	33.33
KB NA Hickory Private Special Asset Fund	Korea	December 31	37.50	37.50
Koramco Europe Core Private Placement Real Estate Fund No.2-2	Korea	December 31	44.02	44.02
BNP Paribas Cardif General Insurance(*9)	Korea	December 31	5.46	7.46
Hermes Private Investment Equity Fund	Korea	December 31	29.17	29.17
Shinhan-Nvestor Liquidity Solution Fund	Korea	December 31	24.92	24.92
Shinhan AIM FoF Fund 1a	Korea	December 31	25.00	25.00
IGIS Global Credit Fund 150-1	Korea	December 31	25.00	25.00
Partner One Value up I Private Equity Fund	Korea	December 31	27.91	27.91
Genesis No.1 Private Equity Fund	Korea	December 31	22.80	22.80
Korea Omega Project Fund III	Korea	December 31	23.53	23.53
Soo Delivery Platform Growth Fund	Korea	December 31	30.00	30.00
Genesis North America Power Company No.1 PEF	Korea	December 31	40.03	39.96
Hyungje art printing(*12)	Korea	-	-	31.54
SH MAIN Professional Investment Type Private Mixed Asset Investment Trust No.3	Korea	December 31	23.33	23.33
Korea Finance Security (*1),(*9)	Korea	September 30	14.91	14.91
Multimedia Tech Co.Ltd.(*12)	Korea	-	-	21.06
MIEL CO.,LTD.(*3),(*4)	Korea	December 31	28.77	28.77
AIP Transportation Specialized Privately Placed Fund Trust #1	Korea	December 31	35.73	35.73
DB Epic Convertiblebond Private Trust No.2(*7)	Korea	-	-	50.98
E&Healthcare Investment Fund No.6	Korea	December 31	21.05	21.05
One Shinhan Global Fund 1(*5)	Korea	December 31	20.56	19.96
Kiwoom-Shinhan Innovation Fund I(*6)	Korea	December 31	50.00	50.00

SHINHAN FINANCIAL GROUP CO., LTD. AND SUBSIDIARIES

Notes to the Consolidated Financial Statements

December 31, 2021 and 2020

(In millions of won)

15. Investments in associates (continued)

(a) Investments in associates as of December 31, 2021 and 2020 are as follows (continued):

Investees	Country	Reporting date	Ownership (%)	
			December 31, 2021	December 31, 2020
Daishin-K&T New Technology Investment Fund	Korea	December 31	31.25	31.25
Midas Asset Global CRE Debt Private Fund No.6	Korea	December 31	41.16	41.16
Richmond Private Investment Trust No.82(*7)	Korea	-	-	60.00
Tiger Alternative Real Estate Professional Private5(*7)	Korea	-	-	48.71
Samchully Midstream Private Placement Special Asset Fund 5-4	Korea	December 31	42.92	42.92
SH Senior Loan Professional Investment Type Private Mixed Asset Investment Trust No.3	Korea	December 31	20.00	20.00
NH-Amundi Global Infrastructure Trust 14	Korea	December 31	30.00	30.00
Jarvis Memorial Private Investment Trust 1(*6)	Korea	December 31	99.01	99.01
Mastern Private Private Investment Trust 68(*7)	Korea	-	-	53.76
Vestas Qualified Investors Private Real Estate Fund Investment Trust No.37(*8)	Korea	December 31	60.00	60.00
Milestone Private Real Estate Fund 3	Korea	December 31	32.06	32.06
IGIS Private Real Estate Investment Trust 286(*7)	Korea	-	-	41.44
Nomura-Rifa Private Real Estate Investment Trust 31	Korea	December 31	31.31	31.31
SH Senior Loan Professional Investment Type Private Mixed Asset Investment Trust No.2	Korea	December 31	21.27	21.27
Hana Semiconductor New Technology Fund(*7)	Korea	-	-	24.30
J&Magnet Startup Venture Specialized Private Equity Fund(*7)	Korea	-	-	24.39
Cape IT Fund No.3	Korea	December 31	32.89	32.89
FuturePlay-Shinhan TechInnovation Fund 1(*6)	Korea	December 31	50.00	50.00
Stonebridge Corporate 1st Fund	Korea	December 31	44.12	44.12
Vogo Realty Partners Private Real Estate Fund V	Korea	December 31	21.64	21.64
Korea Credit Bureau(*1),(9)	Korea	September 30	9.00	9.00
Goduck Gangil1 PFV Co., Ltd.(*1),(9)	Korea	September 30	1.04	1.04
SBC PFV Co., Ltd.(*1),(10)	Korea	September 30	25.00	25.00
NH-amundi global infra private fund 16	Korea	December 31	50.00	50.00
IMM Global Private Equity Fund	Korea	December 31	33.00	33.00
HANA Alternative Estate Professional Private122(*8)	Korea	December 31	74.02	75.19
Hanwha-Incus Plus New Technology Fund No.1(*7)	Korea	-	-	42.64
SH Corporate Professional Investment Type Private Security Investment Trust No.7	Korea	December 31	45.96	45.96
SH BNCT Professional Investment Type Private Special Asset Investment Trust(*11)	Korea	December 31	72.50	72.39
PSA EMP Private Equity Fund(*7)	Korea	-	-	28.99
Deutsche Global Professional Investment Type Private Real Estate Investment Trust No. 24(*8)	Korea	December 31	52.28	52.28
BRAIN DO PROFESSIONALE PRIVATE No. 27	Korea	December 31	29.13	29.13
UI Venture Fund 7th(*7)	Korea	-	-	24.39
Sparklabs-Shinhan Opportunity Fund 1	Korea	December 31	49.50	49.50
BNW Tech-Innovation Private Equity Fund	Korea	December 31	29.85	29.85
IGIS Real-estate Private Investment Trust No.33	Korea	December 31	40.86	40.86
Findvalue PreIPO 6th Professional Investment Type Private Investment Trust(*7)	Korea	-	-	31.58
WWG Global Real Estate Investment Trust no.4	Korea	December 31	29.55	29.55
Goduck Gangil10 PFV Co., Ltd(*1),(9)	Korea	September 30	19.90	19.90
Fidelis Global Private Real Estate Trust No.2(*8)	Korea	December 31	78.26	78.26

SHINHAN FINANCIAL GROUP CO., LTD. AND SUBSIDIARIES

Notes to the Consolidated Financial Statements

December 31, 2021 and 2020

(In millions of won)

15. Investments in associates (continued)

(a) Investments in associates as of December 31, 2021 and 2020 are as follows (continued):

Investees	Country	Reporting date	Ownership (%)	
			December 31, 2021	December 31, 2020
IGIS PRIVATE REAL ESTATE TRUST NO.331(*7)	Korea	-	-	30.77
AIP EURO PRIVATE REAL ESTATE TRUST No. 12	Korea	December 31	28.70	28.70
Shinhan Healthcare Fund 2(*9)	Korea	December 31	13.68	13.68
Pebblestone CGV Private Real Estate Trust No.1	Korea	December 31	48.53	48.53
SH Corporate Professional Investment Type Private Security Investment Trust No.45	Korea	December 31	43.65	-
Shinhan AIM Real Estate Fund No.2	Korea	December 31	30.00	30.00
Shinhan AIM Real Estate Fund No.1	Korea	December 31	21.01	21.01
SH Daegu Green Power Cogeneration System Professional Investment Type Private Special Asset Investment Trust	Korea	December 31	22.02	22.02
SH Sangju YC Expressway Professional Investment Type Private Special Asset Investment Trust	Korea	December 31	29.19	29.19
SH Global Infrastructure Professional Investment Type Private Special Asset Investment Trust No.7-2(*8)	Korea	December 31	71.43	71.43
SH Japan Photovoltaic Private Special Asset Investment Trust No.1(*7)	Korea	-	-	30.00
Korea Omega-Shinhan Project Fund I(*6)	Korea	December 31	50.00	50.00
ST-Bonanja Food tech	Korea	December 31	38.83	38.83
New Green Shinhan Mezzanine Fund(*7)	Korea	-	-	39.22
KORAMKO-Daum Professional Private Investment Trust No.12(*7)	Korea	-	-	33.33
Samsung SRA Real Estate Professional Private 45	Korea	December 31	25.00	25.00
IBK Global New Renewable Energy Special Asset Professional Private2	Korea	December 31	28.98	28.98
VS Cornerstone Fund	Korea	December 31	41.18	41.18
Aone Mezzanine Opportunity Professional Private (*8)	Korea	December 31	66.09	66.12
KiwoomUnicorn3 New Technology Business Investment Fund(*7)	Korea	-	-	21.28
Multi Asset The United States Thortons Professional Private1(*7)	Korea	-	-	25.00
Kiwoom Milestone US Real Estate Professional Private20(*7)	Korea	-	-	75.27
NH-Amundi US Infrastructure Private Fund2	Korea	December 31	25.91	25.91
KB Distribution Private Real Estate1(*8)	Korea	December 31	62.00	62.00
SH Jigae Namsan BTO professional Investment Type Private Special Asset Investment Trust(*7)	Korea	-	-	28.93
SH Japan Photovoltaic Private Special Asset Investment Trust No.2	Korea	December 31	30.00	30.00
Kakao-Shinhan 1st TNYT Fund	Korea	December 31	48.62	48.62
IMM Special Situation 1-2 PRIVATE EQUITY FUND	Korea	December 31	20.00	20.02
Pacific Private Placement Real Estate Fund No.40	Korea	December 31	24.73	24.73
Mastern Private Real Estate Loan Fund No.2	Korea	December 31	33.57	33.57
LB Scotland Amazon Fulfillment Center Fund 29(*8)	Korea	December 31	70.14	70.14
JR AMC Hungary Budapest Office Fund 16	Korea	December 31	32.57	32.57
IGIS 372 Real Estate Professional Private(*7)	Korea	-	-	28.39
EDNCENTRAL Co.,Ltd.(*9)	Korea	December 31	19.87	19.87
KoFC-Neoplux R&D-Biz Creation 2013-1 Venture Capital Fund(*7)	Korea	-	-	19.00
Future-Creation Neoplux Venture Capital Fund(*5)	Korea	December 31	16.25	16.25
Gyeonggi-Neoplux Superman Fund(*5)	Korea	December 31	21.76	21.76
NewWave 6th Fund(*5)	Korea	December 31	30.00	30.00
KTC-NP Growth Champ 2011-2 Private Equity Fund(*5)	Korea	December 31	5.56	5.56

SHINHAN FINANCIAL GROUP CO., LTD. AND SUBSIDIARIES

Notes to the Consolidated Financial Statements

December 31, 2021 and 2020

(In millions of won)

15. Investments in associates (continued)

(a) Investments in associates as of December 31, 2021 and 2020 are as follows (continued):

Investees	Country	Reporting date	Ownership (%)	
			December 31, 2021	December 31, 2020
Neoplux No.3 Private Equity Fund(*5)	Korea	December 31	10.00	10.00
PCC Amberstone Private Equity Fund I	Korea	December 31	21.67	21.67
KIAMCO POWERLOAN TRUST 4TH	Korea	December 31	47.37	47.37
Mastern Opportunity Seeking Real Estate Fund II	Korea	December 31	20.00	20.00
AION ELFIS PROFESSIONAL PRIVATE 1	Korea	December 31	20.00	20.00
T&F 2020 SS Private Equity Fund Specializing in Start-up and Venture Business	Korea	December 31	29.68	29.68
Neoplux Market-Frontier Secondary Fund(*5)	Korea	December 31	19.74	19.74
Harvest Private Equity Fund II	Korea	December 31	22.06	22.06
Synergy Green New Deal 1st New Technology Business Investment Fund	Korea	December 31	28.17	28.17
KAIM Real-estate Private Investment Trust 20	Korea	December 31	38.46	38.46
KIAMCO Vietnam Solar Special Asset Private Investment Trust(*6)	Korea	December 31	50.00	50.00
Daishin New Technology Investment Fund 5th	Korea	December 31	23.44	23.44
CSQUARE SNIPER PROFESSIONAL PRIVATE 10(*8)	Korea	December 31	62.50	62.50
Acurus Hyundai Investment Partners New Technology	Korea	December 31	26.79	26.79
IGIS GLIP Professional Investment Private Real Estate Investment Trust No. 1-1(*8)	Korea	December 31	97.10	97.85
IGIS GLIP Professional Investment Private Real Estate Investment Trust No. 1-2(*8)	Korea	December 31	97.10	97.85
Pacific Sunny Professional Investors Private Placement Real Estate Investment Company No.45	Korea	December 31	25.00	25.00
IGIS Professional Investors Private Investment Real Estate Investment LLC No.395(*7)	Korea	-	-	58.82
SHINHAN-NEO Core Industrial Technology Fund(*5)	Korea	December 31	49.75	49.75
SHBNPP Green New Deal Energy Professional Investment Type Private Special Asset Investment Trust No.2	Korea	December 31	30.00	30.00
SIMONE Mezzanine Fund No.3	Korea	December 31	29.38	29.38
Eum Private Equity Fund No.7	Korea	December 31	21.00	21.00
Kiwoom Private Equity Ant-Man Startup Venture Specialized Private Equity Fund	Korea	December 31	25.00	25.00
Kiwoom Hero No.4 Private Equity Fund	Korea	December 31	21.05	21.05
Vogo Canister Professional Trust Private Fund I	Korea	December 31	36.53	36.68
SW-S Fund	Korea	December 31	30.30	-
CL Buyout 1st PEF	Korea	December 31	21.43	-
Timefolio The Venture-V second	Korea	December 31	20.73	-
Newlake Growth Capital Partners2 PEF	Korea	December 31	29.91	-
Shinhan Smilegate Global PEF I(*9)	Korea	December 31	14.21	-
Fount Professional Investors Private Investment Trust No.3	Korea	December 31	49.98	-
Genesis Eco No.1 PEF	Korea	December 31	29.01	-
SHINHAN-NEO Market-Frontier 2nd Fund(*5)	Korea	December 31	42.70	-
NH-Synergy Core Industrial New Technology Fund	Korea	December 31	36.93	-
J& Moorim Jade Investment Fund	Korea	December 31	24.89	-
Ulmus SHC innovation investment fund	Korea	December 31	24.04	-
Mirae Asset Partners X Private Equity Fund	Korea	December 31	35.71	-
T Core Industrial Technology 1st Venture PEF	Korea	December 31	31.47	-
Curious Finale Corporate Recovery Private Equity Fund	Korea	December 31	27.78	-
TI First Property Private Investment Trust 1	Korea	December 31	40.00	-
MPLUS Professional Private Real Estate Fund 25	Korea	December 31	41.67	-
IBKC Global Contents Investment Fund	Korea	December 31	24.39	-

SHINHAN FINANCIAL GROUP CO., LTD. AND SUBSIDIARIES

Notes to the Consolidated Financial Statements

December 31, 2021 and 2020

(In millions of won)

15. Investments in associates (continued)

(a) Investments in associates as of December 31, 2021 and 2020 are as follows (continued):

Investees	Country	Reporting date	Ownership (%)	
			December 31, 2021	December 31, 2020
Nautic Smart No.6 Private Equity Fund	Korea	December 31	37.74	-
Premier Luminous Private Equity Fund	Korea	December 31	27.78	-
Hanyang-Meritz 1 Fund	Korea	December 31	22.58	-
KNT 2ND PRIVATE EQUITY FUND	Korea	December 31	21.74	-
Maple Mobility Fund	Korea	December 31	20.18	-
AVES 1st Corporate Recovery Private Equity Fund(*6)	Korea	December 31	76.19	-
JS Shinhan Private Equity Fund(*5)	Korea	December 31	3.85	-
Daishin Newgen New Technology Investment Fund 1 st (*8)	Korea	December 31	50.60	-
META ESG Private Equity Fund I	Korea	December 31	27.40	-
SWFV FUND-1	Korea	December 31	40.25	-
PHAROS DK FUND	Korea	December 31	24.24	-
Shinhan VC tomorrow venture fund 1(*5)	Korea	December 31	39.62	-
Highland 2021-8 Fund	Korea	December 31	32.67	-
Medicii 2021-3 Fund	Korea	December 31	24.81	-
Tres-Yujin Trust(*6)	Korea	December 31	50.00	-
Shinhan-Time mezzanine blind Fund(*6)	Korea	December 31	50.00	-
Capstone REITs No.26(*6)	Korea	December 31	50.00	-
JB Incheon-Bucheon REITs No.54	Korea	December 31	39.31	-
Hankook Smart Real Asset Investment Trust No.3	Korea	December 31	33.33	-
JB Hwaseong-Hadong REITs No.53	Korea	December 31	31.03	-
KB Oaktree Trust No.3	Korea	December 31	33.33	-
Daehan No.36 Office Asset Management Company	Korea	December 31	48.05	-
Rhinos Premier Mezzanine Private Investment Fund No.1	Korea	December 31	27.93	-
SH Real Estate Loan Investment Type Private Real Estate Investment Trust No.2	Korea	December 31	29.73	-
Shinhan JigaeNamsan Road Private Special Asset Investment Trust	Korea	December 31	24.85	-
SKS-Yozma Fund No.1	Korea	December 31	29.85	-
IBKC-METIS Global Contents Investment Fund	Korea	December 31	36.36	-
Keystone Unicorn Private Equity Fund	Korea	December 31	28.00	-

(*1) The financial statements of September 30, 2021 are used for the equity method since the financial statements as of December 31, 2021 are not available. Significant trades and events occurred within the period are properly reflected.

(*2) The Group applies the equity method accounting as the Group has a significant influence on the investees through important business transactions.

(*3) In the course of the rehabilitation process, the shares were acquired through investment conversion. Although voting rights cannot be exercised during the rehabilitation process, normal voting rights are exercised because the rehabilitation process was completed before December 31, 2021. Also, it has been reclassified into the investments in associates.

(*4) The latest financial statements are used for the equity method since the financial statements as of December 31, 2021 are not available. Significant trades and events occurred within the period are properly reflected.

(*5) As a managing partner, the Group has a significant influence over the investees.

(*6) As a limited partner, the Group does not have an ability to participate in policy-making processes to obtain economic benefit from the investees that would allow the Group to control the entity.

(*7) Excluded from the investments in associates due to full or partial disposal of shares, or loss of significant influence.

(*8) Although the ownership percentages are more than 50%, the Group applies the equity method accounting as the Group does not have an ability to participate in the financial and operating policy-making process.

(*9) Although the ownership percentages are less than 20%, the Group applies the equity method accounting since it participates in policy-making processes and therefore can exercise significant influence on investees.

(*10) The rate of Group's voting rights is 4.65%.

(*11) Although the Group has a significant influence with ownership percentage more than 50%, the contribution was classified as investments in associates as the Group is not exposed to variable returns due to the payment guarantee for the entire investment amount.

(*12) Excluded from the associates due to redemption of shares.

SHINHAN FINANCIAL GROUP CO., LTD. AND SUBSIDIARIES

Notes to the Consolidated Financial Statements

December 31, 2021 and 2020

(In millions of won)

15. Investments in associates (continued)

(b) Changes in investments in associates for the years ended December 31, 2021 and 2020 are as follows:

Investees	December 31, 2021					
	Beginning balance	Investment and dividend	Equity method income (loss)	Change in other comprehensive income	Impairment loss	Ending balance
BNP Paribas Cardif Life Insurance	₩ 50,600	-	(660)	(5,918)	-	44,022
Songrim Partners(*1)	-	-	-	-	-	-
Partners 4th Growth Investment Fund	11,958	(16,144)	12,525	4,694	-	13,033
KTB Newlake Global Healthcare PEF	9,404	-	8	-	-	9,412
Daekwang Semiconductor Co., Ltd.	3,631	(3,742)	113	(2)	-	-
Shinhan-Neoplux Energy Newbiz Fund	14,470	475	1,087	-	-	16,032
Shinhan-Albatross tech investment Fund	13,322	(9,000)	6,067	-	-	10,389
VOGO Debt Strategy Qualified IV Private	8,702	(1,733)	210	-	-	7,179
Shinhan-Midas Donga Secondary Fund	4,752	(500)	(301)	-	-	3,951
ShinHan – Soo Young Entrepreneur Investment Fund No.1	9,968	(7,879)	2,137	-	-	4,226
Shinhan Praxis K-Growth Global Private Equity Fund	9,945	(2,310)	126	-	-	7,761
Credian Healthcare Private Equity Fund II	5,835	(5,835)	-	-	-	-
Kiwoom Milestone Professional Private Real Estate Trust 19	9,918	(66)	(361)	-	(4,238)	5,253
AIP EURO Green Private Real Estate Trust No.3	21,021	(1,335)	10,017	-	-	29,703
Shinhan Global Healthcare Fund I(*1)	-	-	-	-	-	-
JB Power TL Investment Type Private Placement Special Asset Fund 7	16,186	(15,947)	(239)	-	-	-
KB NA Hickory Private Special Asset Fund	34,938	(2,266)	1,704	-	-	34,376
Koramco Europe Core Private Placement Real Estate Fund No.2-2	18,618	(1,204)	2,078	-	-	19,492
BNP Paribas Cardif General Insurance	3,895	176	(708)	(9)	-	3,354
Hermes Private Investment Equity Fund	6,099	(3,167)	6,850	-	-	9,782
Shinhan-Nvestor Liquidity Solution Fund	4,493	331	514	-	-	5,338
Shinhan AIM FoF Fund 1a	8,760	(79)	475	-	-	9,156
IGIS Global Credit Fund 150-1	7,282	(3,246)	1,366	-	-	5,402
Partner One Value up I Private Equity Fund	11,779	(6,933)	3,045	-	-	7,891
Genesis No.1 Private Equity Fund	80,113	388	(24,968)	-	-	55,533
Korea Omega Project Fund III	3,563	-	727	-	-	4,290
Soo Delivery Platform Growth Fund	4,068	-	1,805	-	-	5,873
Genesis North America Power Company No.1 PEF	16,983	(5,229)	1,982	-	-	13,736
Hyungje art printing(*2)	-	-	-	-	-	-
SH MAIN Professional Investment Type Private Mixed Asset Investment Trust No.3	10,582	24,500	6,467	-	-	41,549
Korea Finance Security	3,055	-	(61)	-	-	2,994
Multimedia Tech Co.Ltd.(*2)	-	-	-	-	-	-
MIEL CO.,LTD.(*1)	-	-	-	-	-	-

SHINHAN FINANCIAL GROUP CO., LTD. AND SUBSIDIARIES

Notes to the Consolidated Financial Statements

December 31, 2021 and 2020

(In millions of won)

15. Investments in associates (continued)

(b) Changes in investments in associates for the years ended December 31, 2021 and 2020 are as follows (continued):

Investees	December 31, 2021					
	Beginning balance	Investment and dividend	Equity method income (loss)	Change in other comprehensive income	Impairment loss	Ending balance
AIP Transportation Specialized Privately Placed Fund Trust #1	₩ 32,993	347	1,348	-	-	34,688
DB Epic Convertiblebond Private Trust No.2	5,785	(5,538)	(247)	-	-	-
E&Healthcare Investment Fund No.6	15,163	(3,431)	(4,866)	-	-	6,866
One Shinhan Global Fund 1	4,029	(519)	263	-	-	3,773
Kiwoom-Shinhan Innovation Fund I	15,969	(5,150)	912	-	-	11,731
Daishin-K&T New Technology Investment Fund	7,000	-	991	-	-	7,991
Midas Asset Global CRE Debt Private Fund No.6	47,389	(2,701)	3,617	-	-	48,305
Richmond Private Investment Trust No.82	15,049	(19,411)	4,362	-	-	-
Tiger Alternative Real Estate Professional Private5	18,499	(20,848)	2,349	-	-	-
Samchully Midstream Private Placement Special Asset Fund 5-4	28,818	(843)	(504)	-	-	27,471
SH Senior Loan Professional Investment Type Private Mixed Asset Investment Trust No.3	65,616	(41,622)	1,210	-	-	25,204
NH-Amundi Global Infrastructure Trust 14	18,819	(1,609)	1,091	-	-	18,301
Jarvis Memorial Private Investment Trust 1	10,043	(700)	766	-	-	10,109
Mastern Private Private Investment Trust 68	10,010	(10,332)	322	-	-	-
Vestas Qualified Investors Private Real Estate Fund Investment Trust No.37	35,641	(4,981)	2,493	-	-	33,153
Milestone Private Real Estate Fund 3	18,528	(472)	488	-	-	18,544
IGIS Private Real Estate Investment Trust 286	8,844	(9,176)	332	-	-	-
Nomura-Rifa Private Real Estate Investment Trust 31	8,407	(705)	200	-	-	7,902
SH Senior Loan Professional Investment Type Private Mixed Asset Investment Trust No.2	13,323	(3,511)	424	-	-	10,236
Hana Semiconductor New Technology Fund	24,131	(26,129)	1,998	-	-	-
J&Magnet Startup Venture Specialized Private Equity Fund	5,935	(7,247)	1,312	-	-	-
Cape IT Fund No.3	10,649	(580)	(4)	-	-	10,065
FuturePlay-Shinhan TechInnovation Fund 1	4,295	3,025	(171)	-	-	7,149
Stonebridge Corporate 1st Fund	3,239	-	(275)	-	-	2,964
Vogo Realty Partners Private Real Estate Fund V	10,827	(681)	620	-	-	10,766
Korea Credit Bureau	6,976	(90)	809	-	-	7,695
Goduck Gangil1 PFV Co., Ltd.(*1)	-	-	-	-	-	-
SBC PFV Co., Ltd.	18,208	12,499	(1,121)	-	-	29,586
NH-amundi global infra private fund 16	43,839	346	7,823	-	-	52,008
IMM Global Private Equity Fund	120,855	(10,462)	8,222	-	-	118,615

SHINHAN FINANCIAL GROUP CO., LTD. AND SUBSIDIARIES

Notes to the Consolidated Financial Statements

December 31, 2021 and 2020

(In millions of won)

15. Investments in associates (continued)

(b) Changes in investments in associates for the years ended December 31, 2021 and 2020 are as follows (continued):

Investees	Beginning balance	Investment and dividend	December 31, 2021				Ending balance
			Equity method income (loss)	Change in other comprehensive income	Impairment loss		
HANA Alternative Estate Professional Private122	₩ 29,631	(1,001)	859	-	-	29,489	
Hanwha-Incus Plus New Technology Fund No.1	11,026	(8,284)	(2,742)	-	-	-	
SH Corporate Professional Investment Type Private Security Investment Trust No.7	51,210	(1,518)	207	-	-	49,899	
SH BNCT Professional Investment Type Private Special Asset Investment Trust	286,531	(15,191)	10,859	-	-	282,199	
PSA EMP Private Equity Fund	9,814	(9,755)	(59)	-	-	-	
Deutsche Global Professional Investment Type Private Real Estate Investment Trust No. 24	29,401	(2,630)	1,541	-	-	28,312	
BRAIN DO PROFESSIONALE PRIVATE No. 27	3,441	(3,048)	583	-	-	976	
UI Venture Fund 7th	3,279	(3,269)	(10)	-	-	-	
Sparklabs-Shinhan Opportunity Fund 1	4,832	-	(192)	-	-	4,640	
BNW Tech-Innovation Private Equity Fund	5,942	-	(61)	-	-	5,881	
IGIS Real-estate Private Investment Trust No.33	14,099	(714)	499	-	-	13,884	
Findvalue PreIPO 6th Professional Investment Type Private Investment Trust	3,002	(3,301)	299	-	-	-	
WWG Global Real Estate Investment Trust no.4	17,752	(7,855)	747	-	-	10,644	
Goduck Gangil10 PFV Co., Ltd(*1)	32	-	(32)	-	-	-	
Fidelis Global Private Real Estate Trust No.2	19,485	(911)	1,199	-	-	19,773	
IGIS PRIVATE REAL ESTATE TRUST NO.331	3,765	(3,765)	-	-	-	-	
AIP EURO PRIVATE REAL ESTATE TRUST No. 12	48,344	(5,436)	6,309	-	-	49,217	
Shinhan Healthcare Fund 2(*1)	986	-	(75)	-	(911)	-	
Pebblestone CGV Private Real Estate Trust No.1	13,346	(748)	1,112	-	-	13,710	
SH Corporate Professional Investment Type Private Security Investment Trust No.45[Bond]	-	174,154	(199)	-	-	173,955	
Shinhan AIM Real Estate Fund No.2	22,464	1,911	(1,100)	-	-	23,275	
Shinhan AIM Real Estate Fund No.1	46,945	(4,412)	1,779	-	-	44,312	
SH Daegu Green Power Cogeneration System Professional Investment Type Private Special Asset Investment Trust	32,944	(911)	915	-	-	32,948	
SH Sangju YC Expressway Professional Investment Type Private Special Asset Investment Trust	20,902	7	(359)	-	-	20,550	
SH Global Infrastructure Professional Investment Type Private Special Asset Investment Trust No.7-2	6,692	13,667	(1,504)	-	-	18,855	
SH Japan Photovoltaic Private Special Asset Investment Trust No.1	4,845	(4,845)	-	-	-	-	
Korea Omega-Shinhan Project Fund I	5,931	2,000	(687)	-	-	7,244	
ST-Bonanja Food tech	1,993	-	1,366	-	-	3,359	
New Green Shinhan Mezzanine Fund	4,916	(5,622)	706	-	-	-	
KORAMKO-Daum Professional Private Investment Trust No.12	7,528	(7,756)	228	-	-	-	

SHINHAN FINANCIAL GROUP CO., LTD. AND SUBSIDIARIES

Notes to the Consolidated Financial Statements

December 31, 2021 and 2020

(In millions of won)

15. Investments in associates (continued)

(b) Changes in investments in associates for the years ended December 31, 2021 and 2020 are as follows (continued):

Investees	Beginning balance	Investment and dividend	December 31, 2021			Ending balance
			Equity method income (loss)	Change in other comprehensive income	Impairment loss	
Samsung SRA Real Estate Professional Private 45	₩ 10,666	2,656	(442)	-	-	12,880
IBK Global New Renewable Energy Special Asset Professional Private2	32,349	(1,988)	1,526	-	-	31,887
VS Cornerstone Fund	3,464	-	(54)	-	-	3,410
Aone Mezzanine Opportunity Professional Private	9,580	(28)	(12)	-	-	9,540
Kiwoom Unicorn3 New Technology Business Investment Fund	4,283	(3,633)	(650)	-	-	-
Multi Asset The United States Thortons Professional Private1	41,440	(41,607)	167	-	-	-
Kiwoom Milestone US Real Estate Professional Private20	51,512	(51,512)	-	-	-	-
NH-Amundi US Infrastructure Private Fund2	25,430	207	1,387	-	-	27,024
KB Distribution Private Real Estate1	30,698	(1,423)	1,419	-	-	30,694
SH Jigae Namsan BTO professional Investment Type Private Special Asset Investment Trust	20,712	(22,293)	1,581	-	-	-
SH Japan Photovoltaic Private Special Asset Investment Trust No.2	29,149	(16,798)	665	-	-	13,016
Kakao-Shinhan 1st TNYT Fund	5,681	9,000	(184)	-	-	14,497
IMM Special Situation 1-2 PRIVATE EQUITY FUND	10,870	(160)	883	-	-	11,593
Pacific Private Placement Real Estate Fund No.40	11,647	(747)	698	-	-	11,598
Mastern Private Real Estate Loan Fund No.2	5,692	1,429	370	-	-	7,491
LB Scotland Amazon Fulfillment Center Fund 29	31,182	(1,734)	1,820	-	-	31,268
JR AMC Hungary Budapest Office Fund 16	12,204	(821)	757	-	-	12,140
IGIS 372 Real Estate Professional Private	56,835	(56,835)	-	-	-	-
EDNCENTRAL Co.,Ltd.(*1)	1,040	-	(1,040)	-	-	-
KoFC-Neoplux R&D-Biz Creation 2013-1 Venture Capital Fund	3,830	(8,388)	4,558	-	-	-
Future-Creation Neoplux Venture Capital Fund	3,796	(995)	216	-	-	3,017
Gyeonggi-Neoplux Superman Fund	6,399	(2,257)	3,736	-	-	7,878
NewWave 6th Fund	6,150	7,575	730	-	-	14,455
KTC-NP Growth Champ 2011-2 Private Equity Fund	2,853	-	1,137	-	-	3,990
Neoplux No.3 Private Equity Fund	10,295	10,182	2,124	-	-	22,601
PCC Amberstone Private Equity Fund I	22,480	(2,356)	2,666	-	-	22,790
KIAMCO POWERLOAN TRUST 4TH	43,955	(164)	1,510	-	-	45,301

SHINHAN FINANCIAL GROUP CO., LTD. AND SUBSIDIARIES

Notes to the Consolidated Financial Statements

December 31, 2021 and 2020

(In millions of won)

15. Investments in associates (continued)

(b) Changes in investments in associates for the years ended December 31, 2021 and 2020 are as follows (continued):

Investees	Beginning balance	Investment and dividend	December 31, 2021			Ending balance
			Equity method income (loss)	Change in other comprehensive income	Impairment loss	
Mastern Opportunity Seeking Real Estate Fund II	₩ 19,799	(737)	2,255	-	-	21,317
AION ELFIS PROFESSIONAL PRIVATE 1	5,528	(1,350)	244	-	-	4,422
T&F 2020 SS Private Equity Fund Specializing in Start-up and Venture Business	4,453	-	(93)	-	-	4,360
Neoplux Market-Frontier Secondary Fund	11,545	(614)	382	-	-	11,313
Harvest Private Equity Fund II	2,982	-	499	-	-	3,481
Synergy Green New Deal 1st New Technology Business Investment Fund	10,008	(247)	(77)	-	-	9,684
KAIM Real-estate Private Investment Trust 20	5,098	(350)	300	-	-	5,048
KIAMCO Vietnam Solar Special Asset Private Investment Trust	7,948	(1,112)	691	-	-	7,527
Daishin New Technology Investment Fund 5th	2,850	-	1,589	-	-	4,439
CSQUARE SNIPER PROFESSIONAL PRIVATE 10	3,125	-	122	-	-	3,247
Acurus Hyundai Investment Partners New Technology	2,927	-	1,787	-	-	4,714
IGIS GLIP Professional Investment Private Real Estate Investment Trust No. 1-1	44,594	4,103	11,371	3,876	-	63,944
IGIS GLIP Professional Investment Private Real Estate Investment Trust No. 1-2	44,594	4,103	11,371	3,876	-	63,944
Pacific Sunny Professional Investors Private Placement Real Estate Investment Company No.45	15,855	-	(1,077)	-	-	14,778
IGIS Professional Investors Private Investment Real Estate Investment LLC No.395	29,644	(29,644)	-	-	-	-
SHINHAN-NEO Core Industrial Technology Fund	1,979	3,960	(248)	-	-	5,691
SHBNPP Green New Deal Energy Professional Investment Type Private Special Asset Investment Trust No.2	21,142	5,271	830	-	-	27,243
SIMONE Mezzanine Fund No.3	2,980	-	74	-	-	3,054
Eum Private Equity Fund No.7	7,872	121	(120)	-	-	7,873
Kiwoom Private Equity Ant-Man Startup Venture Specialized Private Equity Fund	5,034	-	2,560	-	-	7,594
Kiwoom Hero No.4 Private Equity Fund	4,707	-	(402)	-	-	4,305
Vogo Canister Professional Trust Private Fund I	43,975	(4,712)	1,809	-	-	41,072
SW-S Fund	-	7,000	(276)	-	-	6,724
CL Buyout 1st PEF	-	13,875	(84)	-	-	13,791
Timefolio The Venture-V second	-	4,000	572	-	-	4,572
Newlake Growth Capital Partners2 PEF	-	13,000	(79)	-	-	12,921
Shinhan Smilegate Global PEF I	-	3,376	(40)	-	-	3,336
Fount Professional Investors Private Investment Trust No.3	-	5,000	197	-	-	5,197
Genesis Eco No.1 PEF	-	11,292	(162)	-	-	11,130

SHINHAN FINANCIAL GROUP CO., LTD. AND SUBSIDIARIES

Notes to the Consolidated Financial Statements

December 31, 2021 and 2020

(In millions of won)

15. Investments in associates (continued)

(b) Changes in investments in associates for the years ended December 31, 2021 and 2020 are as follows (continued):

Investees	December 31, 2021					
	Beginning balance	Investment and dividend	Equity method income (loss)	Change in other comprehensive income	Impairment loss	Ending balance
SHINHAN-NEO Market-Frontier 2nd Fund(*3)	₩ -	25,620	(1,014)	-	-	24,606
NH-Synergy Core Industrial New Technology Fund	-	6,500	(63)	-	-	6,437
J& Moorim Jade Investment Fund	-	5,500	40	-	-	5,540
Ulmus SHC innovation investment fund	-	5,000	192	-	-	5,192
Mirae Asset Partners X Private Equity Fund	-	8,000	(142)	-	-	7,858
T Core Industrial Technology 1st Venture PEF	-	4,500	35	-	-	4,535
Curious Finale Corporate Recovery Private Equity Fund	-	3,377	313	-	-	3,690
TI First Property Private Investment Trust 1	-	2,879	176	-	-	3,055
MPLUS Professional Private Real Estate Fund 25	-	3,010	280	-	-	3,290
IBKC Global Contents Investment Fund	-	5,000	(57)	-	-	4,943
Nautic Smart No.6 Private Equity Fund	-	4,000	(26)	-	-	3,974
Premier Luminous Private Equity Fund	-	7,095	(104)	-	-	6,991
Hanyang-Meritz 1 Fund	-	3,500	(17)	-	-	3,483
KNT 2ND PRIVATE EQUITY FUND	-	3,000	1,157	-	-	4,157
Maple Mobility Fund	-	9,274	(591)	-	-	8,683
AVES 1st Corporate Recovery Private Equity Fund	-	4,800	(64)	-	-	4,736
JS Shinhan Private Equity Fund	-	5,076	(39)	-	-	5,037
Daishin Newgen New Technology Investment Fund 1 st	-	8,000	4,169	-	-	12,169
META ESG Private Equity Fund I	-	5,726	(49)	-	-	5,677
SWFV FUND-1	-	9,700	(54)	-	-	9,646
PHAROS DK FUND	-	4,000	(51)	-	-	3,949
Shinhan VC tomorrow venture fund 1	-	9,113	(71)	-	-	9,042
Highland 2021-8 Fund	-	4,900	(1)	-	-	4,899
Medicii 2021-3 Fund	-	9,752	(24)	-	-	9,728
Tres-Yujin Trust	-	10,000	(5)	-	-	9,995
Shinhan-Time mezzanine blind Fund	-	15,000	(58)	-	-	14,942
Capstone REITs No.26	-	4,849	(454)	-	-	4,395

SHINHAN FINANCIAL GROUP CO., LTD. AND SUBSIDIARIES

Notes to the Consolidated Financial Statements

December 31, 2021 and 2020

(In millions of won)

15. Investments in associates (continued)

(b) Changes in investments in associates for the years ended December 31, 2021 and 2020 are as follows (continued):

Investees	December 31, 2021					
	Beginning balance	Investment and dividend	Equity method income (loss)	Change in other comprehensive income	Impairment loss	Ending balance
JB Incheon-Bucheon REITS No.54	₩ -	5,000	(1)	-	-	4,999
Hankook Smart Real Asset Investment Trust No.3	-	4,173	169	-	-	4,342
JB Hwaseong-Hadong REITs No.53	-	5,000	(1)	-	-	4,999
KB Oaktree Trust No.3	-	3,141	18	-	-	3,159
Daehan No.36 Office Asset Management Company	-	21,500	-	-	-	21,500
Rhinos Premier Mezzanine Private Investment Fund No.1	-	3,000	5	-	-	3,005
SH Real Estate Loan Investment Type Private Real Estate Investment Trust No.2	-	19,426	477	-	-	19,903
Shinhan JigaeNamsan Road Private Special Asset Investment Trust	-	39,996	109	-	-	40,105
SKS-Yozma Fund No.1	-	6,000	(55)	-	-	5,945
IBKC-METIS Global Contents Investment Fund	-	4,000	-	-	-	4,000
Keystone Unicorn Private Equity Fund	-	6,300	-	-	-	6,300
Others	121,040	63,730	5,881	(3)	(5,571)	185,077
	₩ 2,657,768	101,583	158,600	6,514	(10,720)	2,913,745

(*1) The Group has stopped recognizing its equity method income or loss due to the carrying value of '0' resulting from the investees' cumulative loss.

(*2) For the year ended December 31, 2020, the Group has stopped recognizing its equity method income or loss to accumulated deficits and the shares are retired for the year ended December 31, 2021.

(*3) Classified as investments in associates without cash transactions.

SHINHAN FINANCIAL GROUP CO., LTD. AND SUBSIDIARIES

Notes to the Consolidated Financial Statements

December 31, 2021 and 2020

(In millions of won)

15. Investments in associates (continued)

(b) Changes in investments in associates for the years ended December 31, 2021 and 2020 are as follows (continued):

Investees	₩	December 31, 2020					Ending balance
		Beginning balance	Investment and dividend	Equity method income (loss)	Change in other comprehensive income(loss)	Impairment loss	
BNP Paribas Cardif Life Insurance		52,586	-	(928)	(1,058)	-	50,600
Songrim Partners(*1)		-	-	-	-	-	-
Neoplux Technology Valuation Investment Fund (*3)		16,384	(16,171)	(213)	-	-	-
Partners 4th Growth Investment Fund		14,917	(4,474)	1,515	-	-	11,958
KTB Newlake Global Healthcare PEF		11,280	(1,950)	74	-	-	9,404
Daekwang Semiconductor Co., Ltd.		3,388	-	243	-	-	3,631
Shinhan-Neoplux Energy Newbiz Fund(*4)		7,880	5,887	703	-	-	14,470
Shinhan-Albatross tech investment Fund		8,734	4,650	(62)	-	-	13,322
Plutus-SG Private Equity Fund		4,231	(5,230)	999	-	-	-
Eum Private Equity Fund No.3		3,574	(5,621)	2,050	-	-	3
KTB Confidence Private Placement		6,067	(6,063)	(4)	-	-	-
Meritz AI-SingA330-A Investment Type Private Placement Special Asset Fund		4,256	(772)	(3,484)	-	-	-
Meritz AI-SingA330-B Investment Type Private Placement Special Asset Fund		8,916	(48)	(8,868)	-	-	-
VOGO Debt Strategy Qualified INV Private		9,930	(1,700)	472	-	-	8,702
Shinhan-Midas Donga Secondary Fund		3,486	1,150	116	-	-	4,752
ShinHan – Soo Young Entrepreneur Investment Fund No.1		4,549	1,495	3,924	-	-	9,968
Synergy-Shinhan Mezzanine New Technology Investment Fund		3,912	(4,406)	494	-	-	-
Shinhan Praxis K-Growth Global Private Equity Fund		10,302	78	(435)	-	-	9,945
Credian Healthcare Private Equity Fund II		2,377	(4,937)	8,395	-	-	5,835
Kiwoom Milestone Professional Private Real Estate Trust 19		10,407	(265)	(224)	-	-	9,918
AIP EURO Green Private Real Estate Trust No.3		20,884	(1,189)	1,326	-	-	21,021
Hanhwa US Equity Strategy Private Real Estate Fund No.1		25,964	(26,907)	3,220	-	-	2,277
Shinhan Global Healthcare Fund 1		3,209	-	128	-	(3,337)	-
JB Power TL Investment Type Private Placement Special Asset Fund 7		16,800	(1,359)	745	-	-	16,186
IBK AONE convertible 1		6,077	(6,048)	(29)	-	-	-
Rico synergy collabo Multi-Mezzanine 3		3,217	(3,221)	4	-	-	-
KB NA Hickory Private Special Asset Fund		35,930	(2,609)	1,617	-	-	34,938
Koramco Europe Core Private Placement Real Estate Fund No.2-2		19,562	(1,330)	386	-	-	18,618
BNP Paribas Cardif General Insurance		2,113	3,066	(1,244)	(40)	-	3,895
Axis Global Growth New Technology Investment Association		3,205	(2,920)	(285)	-	-	-
Hermes Private Investment Equity Fund		6,376	-	(277)	-	-	6,099
SHC ULMUS Fund No.1		3,149	(3,289)	140	-	-	-
Shinhan-Nvestor Liquidity Solution Fund		4,865	(1,004)	632	-	-	4,493
Shinhan AIM FoF Fund 1a		7,242	1,324	194	-	-	8,760
IGIS Global Credit Fund 150-1		9,718	(4,002)	1,566	-	-	7,282

SHINHAN FINANCIAL GROUP CO., LTD. AND SUBSIDIARIES

Notes to the Consolidated Financial Statements

December 31, 2021 and 2020

(In millions of won)

15. Investments in associates (continued)

(b) Changes in investments in associates for the years ended December 31, 2021 and 2020 are as follows (continued):

Investees	December 31, 2020					
	Beginning balance	Investment and dividend	Equity method income (loss)	Change in other comprehensive income(loss)	Impairment loss	Ending balance
GX Shinhan Intervest 1st Private Equity Fund	₩ 33,166	(54,515)	21,349	-	-	-
Soo Commerce Platform Growth Fund Partner One Value up I Private Equity Fund	6,343	(8,474)	3,278	-	-	1,147
Genesis No.1 Private Equity Fund	11,891	(20)	(92)	-	-	11,779
GMB ICT New Technology Investment Fund	51,150	388	28,575	-	-	80,113
Korea Omega Project Fund III	7,854	(7,853)	(1)	-	-	-
Soo Delivery Platform Growth Fund	3,016	-	547	-	-	3,563
Genesis North America Power Company No.1 PEF	8,922	(7,929)	3,075	-	-	4,068
Hyungje art printing (*1)	18,275	(3,869)	2,577	-	-	16,983
SHBNPP MAIN Professional Investment Type Private Mixed Asset Investment Trust No.3	-	-	-	-	-	-
Shinhan-Rhinos 1 Fund	20,712	(10,794)	664	-	-	10,582
Pacific Private Investment Trust No.20	3,029	(1,004)	574	-	-	2,599
Susung Mezzanine project P1 Private Investment Trust	4,076	(1,289)	212	-	-	2,999
Korea Finance Security	5,128	(3,613)	(170)	-	-	1,345
Multimedia Tech Co.Ltd (*1)	3,235	-	(180)	-	-	3,055
MIEL CO.,LTD (*1)	19	-	(19)	-	-	-
AIP Transportation Specialized Privately Placed Fund Trust #1	-	-	-	-	-	-
DB Epic Convertiblebond Private Trust No.2	31,580	1,366	47	-	-	32,993
PCC S/W 2nd Fund	5,063	202	520	-	-	5,785
E&Healthcare Investment Fund No.6	3,001	(3,328)	327	-	-	-
One Shinhan Global FundI	7,776	-	7,387	-	-	15,163
Kiwoom-Shinhan Innovation Fund I	4,441	-	(412)	-	-	4,029
Daishin-K&T New Technology Investment Fund	7,284	7,500	1,185	-	-	15,969
Midas Asset Global CRE Debt Private Fund No.6	7,057	-	(57)	-	-	7,000
Richmond Private Investment Trust No.82	23,731	21,537	2,121	-	-	47,389
Tiger Alternative Real Estate Professional Private5	15,120	(855)	784	-	-	15,049
Samchully Midstream Private Placement Special Asset Fund 5-4	19,820	(1,376)	55	-	-	18,499
SHBNPP Senior Loan Professional Investment Type Private Mixed Asset Investment Trust No.3	30,742	(968)	(956)	-	-	28,818
AUCTUS FITRIN Corporate Recovery Private Equity Fund	53,831	9,253	2,532	-	-	65,616
NH-Amundi Global Infrastructure Trust 14	14,358	(14,484)	126	-	-	-
	18,497	(460)	782	-	-	18,819

SHINHAN FINANCIAL GROUP CO., LTD. AND SUBSIDIARIES

Notes to the Consolidated Financial Statements

December 31, 2021 and 2020

(In millions of won)

15. Investments in associates (continued)

(b) Changes in investments in associates for the years ended December 31, 2021 and 2020 are as follows (continued):

Investees		December 31, 2020					Ending balance
		Beginning balance	Investment and dividend	Equity method income (loss)	Change in other comprehensive income(loss)	Impairment loss	
Pacific Private Real Estate Fund Investment Trust No.30 (*3)	₩	14,816	(15,374)	558	-	-	-
Jarvis Memorial Private Investment Trust 1		10,166	(763)	640	-	-	10,043
Mastern Private Private Investment Trust 68		9,999	(460)	471	-	-	10,010
Vestas Qualified Investors Private Real Estate Fund Investment Trust No.37		4,397	30,510	734	-	-	35,641
Milestone Private Real Estate Fund 3 (Derivative Type)		17,186	(838)	2,180	-	-	18,528
IGIS Private Real Estate Investment Trust 286		9,768	(1,361)	437	-	-	8,844
Nomura-Rifa Private Real Estate Investment Trust 31		8,914	(932)	425	-	-	8,407
Lime Pricing Private Equity Fund		8,300	(8,217)	(83)	-	-	-
SHBNPP Senior Loan Professional Investment Type Private Mixed Asset Investment Trust No.2		41,991	(29,980)	1,312	-	-	13,323
DS Solid.II Hedge Fund		4,123	(6,397)	2,274	-	-	-
Hana Semiconductor New Technology Fund		12,856	(2,557)	13,832	-	-	24,131
J&Magnet Startup Venture Specialized Private Equity Fund		5,979	(2,151)	2,107	-	-	5,935
Cape IT Fund No.3		9,967	(580)	1,262	-	-	10,649
FuturePlay-Shinhan TechInnovation Fund I		868	3,661	(234)	-	-	4,295
Stonebridge Corporate 1st Fund		2,981	-	258	-	-	3,239
Vogo Realty Partners Private Real Estate Fund V		10,376	(566)	1,017	-	-	10,827
IL GU FARM CO.,LTD (*1)		-	-	-	-	-	-
Korea Credit Bureau		6,812	(90)	254	-	-	6,976
Goduck Gangil PFV Co., Ltd (*1)		48	-	(48)	-	-	-
SBC PFV Co., Ltd		20,000	-	(1,792)	-	-	18,208
Sprott Global Renewable Private Equity Fund II		19,016	(18,909)	(107)	-	-	-
NH-amundi global infra private fund 16		48,158	(1,236)	(3,083)	-	-	43,839
IMM Global Private Equity Fund		28,925	90,776	1,154	-	-	120,855
HANA Alternative Estate Professional Private122		26,205	(644)	4,070	-	-	29,631
Hanwha-Incus Plus New Technology Fund No.1		5,499	-	5,527	-	-	11,026
SHBNPP Corporate Professional Investment Type Private Security Investment Trust No.7[Bond]		51,293	(1,613)	1,530	-	-	51,210
SHBNPP BNCT Professional Investment Type Private Special Asset Investment Trust		150,317	127,753	8,461	-	-	286,531
PSA EMP Private Equity Fund		9,927	(278)	165	-	-	9,814
Deutsche Global Professional Investment Type Private Real Estate Investment Trust No. 24		29,463	(239)	177	-	-	29,401
SHBNPP Peace of Mind TDF 2035 Security Investment Trust [Equity Balanced-FoF]		5,727	(5,727)	-	-	-	-

SHINHAN FINANCIAL GROUP CO., LTD. AND SUBSIDIARIES

Notes to the Consolidated Financial Statements

December 31, 2021 and 2020

(In millions of won)

15. Investments in associates (continued)

(b) Changes in investments in associates for the years ended December 31, 2021 and 2020 are as follows (continued):

Investees	December 31, 2020					
	Beginning balance	Investment and dividend	Equity method income (loss)	Change in other comprehensive income(loss)	Impairment loss	Ending balance
SHBNPP Peace of Mind TDF 2040 Security Investment Trust [Equity Balanced-FoF]	₩ 5,729	(5,729)	-	-	-	-
BRAIN DO PROFESSIONALE PRIVATE No. 27	3,065	-	376	-	-	3,441
VISION US Muni US Local Debt Opportunities Professional Private1(*3)	9,869	(10,032)	163	-	-	-
UI Venture Fund 7th	-	3,000	279	-	-	3,279
Sparklabs-Shinhan Opportunity Fund 1	-	4,999	(167)	-	-	4,832
BNW Tech-Innovation Private Equity Fund	-	6,000	(58)	-	-	5,942
IGIS Real-estate Private Investment Trust No.33	-	13,945	154	-	-	14,099
Findvalue PreIPO 6th Professional Investment Type Private Investment Trust.	-	3,000	2	-	-	3,002
WWG Global Real Estate Investment Trust no.4	-	16,874	878	-	-	17,752
Fidelis Global Private Real Estate Trust No.2	-	18,582	903	-	-	19,485
IGIS PRIVATE REAL ESTATE TRUST NO.331	-	3,932	(167)	-	-	3,765
AIP EURO PRIVATE REAL ESTATE TRUST No. 12	-	45,082	3,262	-	-	48,344
Pebblestone CGV Private Real Estate Trust No.1	-	12,793	553	-	-	13,346
Shinhan AIM Real Estate Fund No.2(*2)	-	36,186	(7,652)	-	(6,070)	22,464
Shinhan AIM Real Estate Fund No.1(*2)	-	45,415	1,530	-	-	46,945
SHBNPP Daegu Green Power Cogeneration System Professional Investment Type Private Special Asset Investment Trust [Infra business](*2)	-	32,258	686	-	-	32,944
SHBNPP Sangju YC Expressway Professional Investment Type Private Special Asset Investment Trust [Infra business](*2)	-	22,003	(1,101)	-	-	20,902
SHBNPP Global Infrastructure Professional Investment Type Private Special Asset Investment Trust No.7-2(USD)	-	7,273	(581)	-	-	6,692
SHBNPP Japan Photovoltaic Private Special Asset Investment Trust No. 1 [Equity securities-Derivative](*2)	-	4,859	(14)	-	-	4,845
Korea Omega-Shinhan Project Fund I	-	6,000	(69)	-	-	5,931
New Green Shinhan Mezzanine Fund	-	4,000	916	-	-	4,916
KORAMKO-Daum Professional Private Investment Trust No.12	-	6,930	598	-	-	7,528
Samsung SRA Real Estate Professional Private 45[FoFs]	-	10,701	(35)	-	-	10,666
IBK Global New Renewable Energy Special Asset Professional Private2	-	29,177	3,172	-	-	32,349
VS Cornerstone Fund	-	3,500	(36)	-	-	3,464
Aone Mezzanine Opportunity Professional Private	-	8,000	1,580	-	-	9,580
Kiwoom Unicorn3 New Technology Business Investment Fund	-	3,000	1,283	-	-	4,283

SHINHAN FINANCIAL GROUP CO., LTD. AND SUBSIDIARIES

Notes to the Consolidated Financial Statements

December 31, 2021 and 2020

(In millions of won)

15. Investments in associates (continued)

(b) Changes in investments in associates for the years ended December 31, 2021 and 2020 are as follows (continued):

Investees	December 31, 2020					
	Beginning balance	Investment and dividend	Equity method income (loss)	Change in other comprehensive income(loss)	Impairment loss	Ending balance
Multi Asset The United States Thortons Professional Private1(*2)	₩ -	44,202	(2,762)	-	-	41,440
Kiwoom Milestone US Real Estate Professional Private20	-	49,791	1,721	-	-	51,512
NH-Amundi US Infrastructure Private Fund2(*2)	-	24,647	783	-	-	25,430
KB Distribution Private Real Estate1(*2)	-	29,984	714	-	-	30,698
SHBNPP Jigae Namsan BTO professional Investment Type Private Special Asset Investment Trust [Infra business](*2)	-	19,968	744	-	-	20,712
SHBNPP Japan Photovoltaic Private Special Asset Investment Trust No.2 [Loan-Derivative](*2)	-	28,251	898	-	-	29,149
Kakao-Shinhan 1st TNYT Fund	-	6,000	(319)	-	-	5,681
IMM Special Situation 1-2 PRIVATE EQUITY FUND	-	10,000	870	-	-	10,870
Pacific Private Placement Real Estate Fund No.40	-	11,273	374	-	-	11,647
Mastern Private Real Estate Loan Fund No.2	-	5,740	(48)	-	-	5,692
LB Scotland Amazon Fulfillment Center Fund 29	-	30,753	429	-	-	31,182
JR AMC Hungary Budapest Office Fund 16	-	11,380	824	-	-	12,204
IGIS 372 Real Estate Professional Private	-	58,200	(1,365)	-	-	56,835
KoFC-Neoplux R&D-Biz Creation 2013-1 Venture Capital Fund(*4)	-	4,058	(228)	-	-	3,830
Future-Creation Neoplux Venture Capital Fund(*4)	-	4,204	(408)	-	-	3,796
Gyeonggi-Neoplux Superman Fund(*4)	-	7,665	(1,266)	-	-	6,399
NewWave 6th Fund(*4)	-	6,242	(92)	-	-	6,150
Neoplux No.3 Private Equity Fund(*4)	-	10,825	(530)	-	-	10,295
PCC Amberstone Private Equity Fund I(*2)	-	22,066	414	-	-	22,480
KIAMCO POWERLOAN TRUST 4TH Mastern Opportunity Seeking Real Estate Fund II	-	43,390	565	-	-	43,955
AION ELFIS PROFESSIONAL PRIVATE 1	-	19,508	291	-	-	19,799
T&F 2020 SS Private Equity Fund Specializing in Start-up and Venture Business	-	5,000	528	-	-	5,528
Neoplux Market-Frontier Secondary Fund(*4)	-	4,500	(47)	-	-	4,453
Synergy Green New Deal 1st New Technology Business Investment Fund	-	10,974	571	-	-	11,545
KAIM Real-estate Private Investment Trust 20	-	10,000	8	-	-	10,008
KIAMCO Vietnam Solar Special Asset Private Investment Trust	-	5,000	98	-	-	5,098
CSQUARE SNIPER PROFESSIONAL PRIVATE 10	-	8,150	(202)	-	-	7,948
IGIS GLIP Professional Investment Private Real Estate Investment Trust No. 1-1	-	3,125	-	-	-	3,125
	-	44,780	(9)	(177)	-	44,594

SHINHAN FINANCIAL GROUP CO., LTD. AND SUBSIDIARIES

Notes to the Consolidated Financial Statements

December 31, 2021 and 2020

(In millions of won)

15. Investments in associates (continued)

(b) Changes in investments in associates for the years ended December 31, 2021 and 2020 are as follows (continued):

Investees	December 31, 2020					
	Beginning balance	Investment and dividend	Equity method income (loss)	Change in other comprehensive income(loss)	Impairment loss	Ending balance
IGIS GLIP Professional Investment Private Real Estate Investment Trust No. 1-2	₩ -	44,780	(9)	(177)	-	44,594
Pacific Sunny Professional Investors Private Placement Real Estate Investment Company No.45	-	16,000	(145)	-	-	15,855
IGIS Professional Investors Private Investment Real Estate Investment LLC No.395	-	30,000	(356)	-	-	29,644
SHBNPP Green New Deal Energy Professional Investment Type Private Special Asset Investment Trust No.2	-	21,142	-	-	-	21,142
Eum Private Equity Fund No.7	-	7,872	-	-	-	7,872
Kiwoom Private Equity Anti-Man Startup Venture Specialized Private Equity Fund	-	5,034	-	-	-	5,034
Kiwoom Hero No.4 Private Equity Fund	-	4,707	-	-	-	4,707
Vogo Canister Professional Trust Private Fund I(*2)	-	43,975	-	-	-	43,975
Others	85,517	25,966	19,814	(5)	-	131,292
	₩ 1,452,861	1,056,238	159,533	(1,457)	(9,407)	2,657,768

(*1) The Group has stopped recognizing its equity method income or loss due to the carrying value of '0' resulting from the investees' cumulative loss.

(*2) Classified as investments in associates without cash transactions.

(*3) For the year ended December 31, 2020, it is incorporated into the consolidation target as it held control due to increased equity ratio.

(*4) For the year ended December 31, 2020, it is incorporated into the investments in associates as Neoplux Co., Ltd. is incorporated into the consolidation target.

SHINHAN FINANCIAL GROUP CO., LTD. AND SUBSIDIARIES

Notes to the Consolidated Financial Statements

December 31, 2021 and 2020

(In millions of won)

15. Investments in associates (continued)

(c) The statement of financial information as of and for the years ended December 31, 2021 and 2020 are as follows:

Investees	December 31, 2021						
	Asset	Liability	Operating revenue	Net profit (loss)	Other comprehensive income (loss)	Total comprehensive income (loss)	
BNP Paribas Cardif Life Insurance ₩	3,268,153	2,974,519	48,207	(4,499)	(39,454)	(43,953)	
Songrim Partners	1,003	1,065	548	-	-	-	
Partners 4th Growth Investment Fund	60,073	7,939	52,019	50,100	18,774	68,874	
KTB Newlake Global Healthcare PEF	30,969	161	552	27	-	27	
Shinhan-Neoplux Energy Newbiz Fund	66,213	1,002	20,575	18,016	-	18,016	
Shinhan-Albatross tech investment Fund	20,677	464	12,058	10,912	-	10,912	
VOGO Debt Strategy Qualified IV Private	35,919	23	5,393	1,138	-	1,138	
Shinhan-Midas Donga Secondary Fund	7,902	-	72	(602)	-	(602)	
ShinHan – Soo Young Entrepreneur Investment Fund No.1	17,960	352	27,318	8,906	-	8,906	
Shinhan Praxis K-Growth Global Private Equity Fund	41,193	60	1,217	669	-	669	
Kiwoom Milestone Professional Private Real Estate Trust 19	49,101	38,596	2,505	(9,199)	-	(9,199)	
AIP EURO Green Private Real Estate Trust No.3	219,110	79,534	52,789	47,070	-	47,070	
Shinhan Global Healthcare Fund 1	43	3,507	-	(1,414)	-	(1,414)	
KB NA Hickory Private Special Asset Fund	91,752	84	15,540	4,502	-	4,502	
Koramco Europe Core Private Placement Real Estate Fund No.2-2	46,169	1,894	7,743	4,719	-	4,719	
BNP Paribas Cardif General Insurance	140,179	78,748	61,951	(6,872)	(28)	(6,900)	
Hermes Private Investment Equity Fund	33,545	8	23,536	23,486	-	23,486	
Shinhan-Nvestor Liquidity Solution Fund	21,420	-	2,169	2,064	-	2,064	
Shinhan AIM FoF Fund 1a	36,651	28	4,527	(1,466)	-	(1,466)	
IGIS Global Credit Fund 150-1	21,625	16	3,138	1,763	-	1,763	
Partner One Value up I Private Equity Fund	28,273	-	304	10,910	-	10,910	
Genesis No.1 Private Equity Fund	243,534	-	-	(109,494)	-	(109,494)	
Korea Omega Project Fund III	18,234	-	3,154	3,093	-	3,093	
Soo Delivery Platform Growth Fund	19,578	-	6,243	6,018	-	6,018	
Genesis North America Power Company No.1 PEF	34,626	316	11,654	4,951	-	4,951	
SH MAIN Professional Investment Type Private Mixed Asset Investment Trust No.3	178,427	358	28,997	27,719	-	27,719	
Korea Finance Security	35,044	14,966	63,693	(412)	-	(412)	
MIEL CO.,LTD.	491	632	36	(56)	-	(56)	

SHINHAN FINANCIAL GROUP CO., LTD. AND SUBSIDIARIES

Notes to the Consolidated Financial Statements

December 31, 2021 and 2020

(In millions of won)

15. Investments in associates (continued)

(c) The statement of financial information as of and for the years ended December 31, 2021 and 2020 are as follows(continued):

Investees	December 31, 2021						
	Asset	Liability	Operating revenue	Net profit (loss)	Other comprehensive income (loss)	Total comprehensive income (loss)	
AIP Transportation Specialized Privately Placed Fund Trust #1	₩ 104,512	7,415	16,239	3,773	-	3,773	
E&Healthcare Investment Fund No.6	32,615	-	17,133	(23,116)	-	(23,116)	
One Shinhan Global Fund 1	15,799	41	8,276	(1,280)	-	(1,280)	
Kiwoom-Shinhan Innovation Fund I	23,613	151	4,803	1,823	-	1,823	
Daishin-K&T New Technology Investment Fund	25,637	66	8,639	3,171	-	3,171	
Midas Asset Global CRE Debt Private Fund No.6	117,396	49	2,817	1,451	-	1,451	
Samchully Midstream Private Placement Special Asset Fund 5-4	65,966	35	11,141	(4,113)	-	(4,113)	
SH Senior Loan Professional Investment Type Private Mixed Asset Investment Trust No.3	126,043	23	6,544	6,048	-	6,048	
NH-Amundi Global Infrastructure Trust 14	61,005	1	4,134	4	-	4	
Jarvis Memorial Private Investment Trust 1	10,214	4	39	35	-	35	
Vestas Qualified Investors Private Real Estate Fund Investment Trust No.37	55,273	19	6,500	23	-	23	
Milestone Private Real Estate Fund 3	57,956	114	1,880	1,522	-	1,522	
Nomura-Rifa Private Real Estate Investment Trust 31	97,211	72,103	7,364	639	-	639	
SH Senior Loan Professional Investment Type Private Mixed Asset Investment Trust No.2	48,157	33	2,106	1,991	-	1,991	
Cape IT Fund No.3	30,651	52	2,100	(11)	-	(11)	
FuturePlay-Shinhan TechInnovation Fund 1	14,297	-	3	(342)	-	(342)	
Stonebridge Corporate 1st Fund	6,718	-	1	(622)	-	(622)	
Vogo Realty Partners Private Real Estate Fund V	49,842	82	2,110	(2,066)	-	(2,066)	
Korea Credit Bureau	129,478	43,981	121,982	8,988	-	8,988	
Goduck Gangill PFV Co., Ltd	301,513	317,276	88,085	(1,835)	-	(1,835)	
SBC PFV Co., Ltd.	334,262	175,976	-	(4,462)	-	(4,462)	
NH-amundi global infra private fund 16	297,837	193,821	25,560	14,770	-	14,770	
IMM Global Private Equity Fund	362,514	3,099	50,060	24,933	-	24,933	
HANA Alternative Estate Professional Private122	39,878	38	2,608	1,160	-	1,160	
SH Corporate Professional Investment Type Private Security Investment Trust No.7	268,037	167,939	3,231	415	-	415	
SH BNCT Professional Investment Type Private Special Asset Investment Trust	389,240	-	14,978	14,978	-	14,978	
Deutsche Global Professional Investment Type Private Real Estate Investment Trust No. 24	54,914	756	23,920	2,948	-	2,948	
BRAIN DO PROFESSIONALE PRIVATE No. 27	3,351	-	2,002	2,002	-	2,002	
Sparklabs-Shinhan Opportunity Fund 1	9,372	-	-	(388)	-	(388)	
BNW Tech-Innovation Private Equity Fund	20,215	513	95	(204)	-	(204)	

SHINHAN FINANCIAL GROUP CO., LTD. AND SUBSIDIARIES

Notes to the Consolidated Financial Statements

December 31, 2021 and 2020

(In millions of won)

15. Investments in associates (continued)

(c) The statement of financial information as of and for the years ended December 31, 2021 and 2020 are as follows(continued):

Investees	December 31, 2021					
	Asset	Liability	Operating revenue	Net profit (loss)	Other comprehensive income (loss)	Total comprehensive income (loss)
IGIS Real-estate Private Investment Trust No.33	₩ 87,790	53,808	1,123	440	-	440
WWG Global Real Estate Investment Trust no.4	36,030	11	2,538	293	-	293
Goduck Gangil10 PFV Co., Ltd	253,607	261,969	-	(8,526)	-	(8,526)
Fidelis Global Private Real Estate Trust No.2	25,271	6	1,575	1,532	-	1,532
AIP EURO PRIVATE REAL ESTATE TRUST No. 12	172,398	909	23,567	21,983	-	21,983
Shinhan Healthcare Fund 2	35	138	340	(7,310)	-	(7,310)
Pebblestone CGV Private Real Estate Trust No.1	64,667	36,415	7,147	2,350	-	2,350
Shinhan AIM Real Estate Fund No.2	79,162	1,580	9,672	(3,666)	-	(3,666)
Shinhan AIM Real Estate Fund No.1	226,809	15,901	20,209	8,467	-	8,467
SH Daegu Green Power Cogeneration System Professional Investment Type Private Special Asset Investment Trust	149,702	75	4,451	4,152	-	4,152
SH Sangju YC Expressway Professional Investment Type Private Special Asset Investment Trust	70,637	236	-	(1,231)	-	(1,231)
SH Global Infrastructure Professional Investment Type Private Special Asset Investment Trust No.7-2(USD)	26,429	33	2,310	(2,105)	-	(2,105)
Korea Omega-Shinhan Project Fund I	14,488	-	-	(1,373)	-	(1,373)
ST-Bonanja Food tech	8,650	-	3,666	3,519	-	3,519
Samsung SRA Real Estate Professional Private 45	56,083	4,564	3,833	(1,769)	-	(1,769)
IBK Global New Renewable Energy Special Asset Professional Private2	114,645	4,633	5,520	5,265	-	5,265
VS Cornerstone Fund	8,281	-	2	(132)	-	(132)
Aone Mezzanine Opportunity Professional Private	15,247	800	1,409	(18)	-	(18)
NH-Amundi US Infrastructure Private Fund2	104,374	61	6,769	5,351	-	5,351
KB Distribution Private Real Estate1	50,014	508	2,335	2,289	-	2,289
SH Jigae Namsan BTO professional Investment Type Private Special Asset Investment Trust	43,540	155	7,216	2,216	-	2,216
Kakao-Shinhan 1st TNYT Fund	29,948	133	8	(379)	-	(379)
IMM Special Situation 1-2 PRIVATE EQUITY FUND	57,965	3	4,610	4,418	-	4,418
Pacific Private Placement Real Estate Fund No.40	46,898	-	398	398	-	398
Mastern Private Real Estate Loan Fund No.2	22,453	139	549	410	-	410
LB Scotland Amazon Fulfillment Center Fund 29	44,614	37	5,177	3,345	-	3,345
JR AMC Hungary Budapest Office Fund 16	38,545	1,271	-	-	-	-
EDNCENTRAL Co.,Ltd.	94,405	96,892	1,381	(5,093)	-	(5,093)
Future-Creation Neoplux Venture Capital Fund	22,488	3,919	10,294	1,332	-	1,332

SHINHAN FINANCIAL GROUP CO., LTD. AND SUBSIDIARIES

Notes to the Consolidated Financial Statements

December 31, 2021 and 2020

(In millions of won)

15. Investments in associates (continued)

(c) The statement of financial information as of and for the years ended December 31, 2021 and 2020 are as follows(continued):

Investees	December 31, 2021						
	Asset	Liability	Operating revenue	Net profit (loss)	Other comprehensive income (loss)	Total comprehensive income (loss)	
Gyeonggi-Neoplux Superman Fund ₩	36,815	620	21,349	17,163	-	17,163	
NewWave 6th Fund	48,185	-	4,009	2,434	-	2,434	
KTC-NP Growth Champ 2011-2 Private Equity Fund	80,853	9,024	20,479	20,472	-	20,472	
Neoplux No.3 Private Equity Fund	226,970	962	38,467	21,233	-	21,233	
PCC Amberstone Private Equity Fund I	105,169	-	12,174	12,302	-	12,302	
KIAMCO POWERLOAN TRUST 4TH	95,658	24	3,282	3,188	-	3,188	
Mastern Opportunity Seeking Real Estate Fund II	111,276	4,692	11,332	11,274	-	11,274	
AION ELFIS PROFESSIONAL PRIVATE 1	22,143	31	4,212	1,219	-	1,219	
T&F 2020 SS Private Equity Fund Specializing in Start-up and Venture Business	15,062	374	-	(312)	-	(312)	
Neoplux Market-Frontier Secondary Fund	58,273	954	7,913	1,932	-	1,932	
Harvest Private Equity Fund II	15,877	97	2,496	2,262	-	2,262	
Synergy Green New Deal 1st New Technology Business Investment Fund	34,379	-	977	(272)	-	(272)	
KAIM Real-estate Private Investment Trust 20	13,125	-	125	125	-	125	
KIAMCO Vietnam Solar Special Asset Private Investment Trust	15,065	12	-	-	-	-	
Daishin New Technology Investment Fund 5th	18,970	30	6,903	6,778	-	6,778	
CSQUARE SNIPER PROFESSIONAL PRIVATE 10	5,269	75	425	195	-	195	
Acurus Hyundai Investment Partners New Technology	17,642	42	6,881	6,679	-	6,679	
IGIS GLIP Professional Investment Private Real Estate Investment Trust No. 1-1	60,740	59	6,767	6,637	2,339	8,976	
IGIS GLIP Professional Investment Private Real Estate Investment Trust No. 1-2	60,740	59	6,767	6,637	2,339	8,976	
Pacific Sunny Professional Investors Private Placement Real Estate Investment Company No.45	134,667	94,282	6	(8,090)	-	(8,090)	
SHINHAN-NEO Core Industrial Technology Fund	11,439	-	5	(499)	-	(499)	
SHBNPP Green New Deal Energy Professional Investment Type Private Special Asset Investment Trust No.2	90,848	38	3,650	2,767	-	2,767	
SIMONE Mezzanine Fund No.3	10,404	9	345	253	-	253	
Eum Private Equity Fund No.7	37,495	-	-	(573)	-	(573)	

SHINHAN FINANCIAL GROUP CO., LTD. AND SUBSIDIARIES

Notes to the Consolidated Financial Statements

December 31, 2021 and 2020

(In millions of won)

15. Investments in associates (continued)

(c) The statement of financial information as of and for the years ended December 31, 2021 and 2020 are as follows(continued) :

Investees	December 31, 2021					
	Asset	Liability	Operating revenue	Net profit (loss)	Other comprehensive income (loss)	Total comprehensive income (loss)
Kiwoom Private Equity Ant-Man Startup Venture Specialized Private Equity Fund	₩ 30,434	59	10,475	10,241	-	10,241
Kiwoom Hero No.4 Private Equity Fund	20,478	29	1	(1,908)	-	(1,908)
Vogo Canister Professional Trust Private Fund I	112,505	72	16,029	4,949	-	4,949
SW-S Fund	22,191	-	-	(909)	-	(909)
CL Buyout 1st PEF	64,518	159	1	(390)	-	(390)
Timefolio The Venture-V second	22,829	769	3,361	2,941	-	2,941
Newlake Growth Capital Partners2 PEF	43,187	-	290	(263)	-	(263)
Shinhan Smilegate Global PEF I	23,469	-	-	(281)	-	(281)
Fount Professional Investors Private Investment Trust No.3	10,416	17	411	394	-	394
Genesis Eco No.1 PEF	38,369	4	308	(377)	-	(377)
SHINHAN-NEO Market-Frontier 2nd Fund	58,138	513	1,466	(2,375)	-	(2,375)
NH-Synergy Core Industrial New Technology Fund	17,430	-	-	(170)	-	(170)
J& Moorim Jade Investment Fund	22,265	6	356	160	-	160
Ulmus SHC innovation investment fund	21,601	-	956	801	-	801
Mirae Asset Partners X Private Equity Fund	22,035	33	1	(398)	-	(398)
T Core Industrial Technology 1st Venture PEF	14,418	5	197	113	-	113
Curious Finale Corporate Recovery Private Equity Fund	13,346	61	1,275	1,126	-	1,126
TI First Property Private Investment Trust 1	7,654	17	156	139	-	139
MPLUS Professional Private Real Estate Fund 25	8,186	290	451	396	-	396
IBKC Global Contents Investment Fund	20,265	-	-	(235)	-	(235)
Nautic Smart No.6 Private Equity Fund	10,565	32	50	(68)	-	(68)
Premier Luminous Private Equity Fund	25,170	3	-	(375)	-	(375)
Hanyang-Meritz 1 Fund	15,423	-	-	(77)	-	(77)
KNT 2ND PRIVATE EQUITY FUND	19,133	9	5,402	5,324	-	5,324

SHINHAN FINANCIAL GROUP CO., LTD. AND SUBSIDIARIES

Notes to the Consolidated Financial Statements

December 31, 2021 and 2020

(In millions of won)

15. Investments in associates (continued)

(c) The statement of financial information as of and for the years ended December 31, 2021 and 2020 are as follows(continued) :

Investees	December 31, 2021						
	Asset	Liability	Operating revenue	Net profit (loss)	Other comprehensive income (loss)	Total comprehensive income (loss)	
Maple Mobility Fund	₩ 43,024	1	-	(2,930)	-	(2,930)	
AVES 1st Corporate Recovery Private Equity Fund	6,215	-	-	(85)	-	(85)	
JS Shinhan Private Equity Fund	130,967	1	7	(1,036)	-	(1,036)	
Daishin Newgen New Technology Investment Fund 1 st	24,050	2	1	8,238	-	8,238	
META ESG Private Equity Fund I	21,722	-	1	(178)	-	(178)	
SWFV FUND-1	24,055	90	-	(135)	-	(135)	
PHAROS DK FUND	16,349	60	-	(210)	-	(210)	
Shinhan VC tomorrow venture fund 1	22,603	-	23	(397)	-	(397)	
Highland 2021-8 Fund	15,000	2	-	(2)	-	(2)	
Medicii 2021-3 Fund	39,217	15	-	(98)	-	(98)	
Tres-Yujin Trust	20,000	11	-	(11)	-	(11)	
Shinhan-Time mezzanine blind Fund	29,885	-	-	(115)	-	(115)	
Capstone REITs No.26	12,223	3,433	-	-	-	-	
JB Incheon-Bucheon REITS No.54	12,718	2	-	(2)	-	(2)	
Hankook Smart Real Asset Investment Trust No.3	13,146	120	532	506	-	506	
JB Hwaseong-Hadong REITs No.53	16,113	2	-	(2)	-	(2)	
KB Oaktree Trust No.3	9,552	77	130	52	-	52	
Daehan No.36 Office Asset Management Company	133,884	95,993	1,000	111	-	111	
Rhinos Premier Mezzanine Private Investment Fund No.1	10,759	-	19	17	-	17	
SH Real Estate Loan Investment Type Private Real Estate Investment Trust No.2	66,959	12	1,617	1,605	-	1,605	
Shinhan JigaeNamsan Road Private Special Asset Investment Trust	161,417	27	467	440	-	440	
SKS-Yozma Fund No.1	19,915	-	1	(185)	-	(185)	

(*) Excluded the financial information of associates that are not subject to equity method due to disposal or of which the financial information is not available as of end of the year.

SHINHAN FINANCIAL GROUP CO., LTD. AND SUBSIDIARIES

Notes to the Consolidated Financial Statements

December 31, 2021 and 2020

(In millions of won)

15. Investments in associates (continued)

(c) The statement of financial information as of and for the years ended December 31, 2021 and 2020 are as follows(continued):

Investees	December 31, 2020						
	Asset	Liability	Operating revenue	Net profit (loss)	Other comprehensive income (loss)	Total comprehensive income (loss)	
BNP Paribas Cardif Life Insurance	₩ 3,526,148	3,188,562	38,669	(6,555)	(7,052)	(13,607)	
Songrim Partners	1,003	1,065	548	-	-	-	
Partners 4th Growth Investment Fund	48,678	846	7,231	6,059	-	6,059	
KTB Newlake Global Healthcare PEF	31,005	225	598	244	-	244	
Daekwang Semiconductor Co., Ltd.	23,682	6,339	3,836	1,163	-	1,163	
Shinhan-Neoplux Energy Newbiz Fund	44,615	25	4,221	1,749	-	1,749	
Shinhan-Albatross tech investment Fund	27,685	385	982	594	-	594	
Eum Private Equity Fund No.3	20	4	13,445	9,875	-	9,875	
Meritz AI-SingA330-A Investment Type Private Placement Special Asset Fund	1	1	89	89	-	89	
Meritz AI-SingA330-B Investment Type Private Placement Special Asset Fund	2	2	363	361	-	361	
VOGO Debt Strategy Qualified INV Private	43,540	28	6,361	2,359	-	2,359	
Shinhan-Midas Donga Secondary Fund	9,504	-	365	233	-	233	
ShinHan – Soo Young Entrepreneur Investment Fund No.1	41,532	-	16,561	16,349	-	16,349	
Shinhan Praxis K-Growth Global Private Equity Fund	52,890	183	201	(2,306)	-	(2,306)	
Credian Healthcare Private Equity Fund II	17,141	15	25,926	24,638	-	24,638	
Kiwoom Milestone Professional Private Real Estate Trust 19	58,393	38,558	2,772	(449)	-	(449)	
AIP EURO Green Private Real Estate Trust No.3	98,866	86	6,893	6,231	-	6,231	
Hanhwa US Equity Strategy Private Real Estate Fund No.1	5,798	721	32,667	7,180	-	7,180	
Shinhan Global Healthcare Fund 1	55	2,104	1,034	(74,736)	-	(74,736)	
JB Power TL Investment Type Private Placement Special Asset Fund 7	48,605	45	23,547	2,251	-	2,251	
KB NA Hickory Private Special Asset Fund	93,236	69	13,464	4,312	-	4,312	
Koramco Europe Core Private Placement Real Estate Fund No.2-2	46,239	3,948	4,920	877	-	877	
BNP Paribas Cardif General Insurance	85,278	33,063	23,632	(7,972)	(161)	(8,133)	
Hermes Private Investment Equity Fund	20,919	8	11	(948)	-	(948)	
Shinhan-Nvestor Liquidity Solution Fund	18,032	-	2,704	2,537	-	2,537	
Shinhan AIM FoF Fund 1a	35,060	20	4,378	777	-	777	
IGIS Global Credit Fund 150-1	29,153	24	10,076	6,263	-	6,263	
Soo Commerce Platform Growth Fund	4,661	3	13,172	13,314	-	13,314	
Partner One Value up I Private Equity Fund	42,205	-	457	(329)	-	(329)	
Genesis No.1 Private Equity Fund	382,353	31,024	158,070	125,312	-	125,312	

SHINHAN FINANCIAL GROUP CO., LTD. AND SUBSIDIARIES

Notes to the Consolidated Financial Statements

December 31, 2021 and 2020

(In millions of won)

15. Investments in associates (continued)

(c) The statement of financial information as of and for the years ended December 31, 2021 and 2020 are as follows (continued):

Investees	December 31, 2020					
	Asset	Liability	Operating revenue	Net profit (loss)	Other comprehensive income (loss)	Total comprehensive income (loss)
Korea Omega Project Fund III	₩ 15,141	-	2,383	2,323	-	2,323
Soo Delivery Platform Growth Fund	13,563	3	11,300	10,249	-	10,249
Genesis North America Power Company No.1 PEF	48,221	5,727	6,976	6,449	-	6,449
Hyungje art printing	866	1,130	253	-	-	-
SHBNPP MAIN Professional Investment Type Private Mixed Asset Investment Trust No.3	46,514	1,164	11,240	2,846	-	2,846
Shinhan-Rhinos 1 Fund	11,561	1	2,784	2,554	-	2,554
Pacific Private Investment Trust No.20	13,805	11	974	974	-	974
Susung Mezzanine project P1 Private Investment Trust	3,220	-	3,412	(373)	-	(373)
Korea Finance Security	37,522	17,032	118,906	(1,174)	-	(1,174)
Multimedia Tech Co.Ltd	593	662	555	(158)	-	(158)
MIEL CO.,LTD	474	559	585	(169)	-	(169)
AIP Transportation Specialized Privately Placed Fund Trust #1	92,454	101	17,221	132	-	132
DB Epic Convertiblebond Private Trust No.2	11,382	34	1,169	1,021	-	1,021
E&Healthcare Investment Fund No.6	72,023	-	36,332	33,844	-	33,844
One Shinhan Global Fund1	22,244	-	92	(406)	-	(406)
Kiwoom-Shinhan Innovation Fund I	32,096	158	2,984	2,371	-	2,371
Daishin-K&T New Technology Investment Fund	55,501	33,101	64	(183)	-	(183)
Midas Asset Global CRE Debt Private Fund No.6	115,240	118	7,041	5,153	-	5,153
Richmond Private Investment Trust No.82	49,961	24,879	1,658	1,306	-	1,306
Tiger Alternative Real Estate Professional Private5	38,064	86	7,827	113	-	113
Samchully Midstream Private Placement Special Asset Fund 5-4	67,177	36	8,012	(2,228)	-	(2,228)
SHBNPP Senior Loan Professional Investment Type Private Mixed Asset Investment Trust No.3	327,973	56	13,607	12,656	-	12,656
NH-Amundi Global Infrastructure Trust 14	62,729	1	7,216	2,606	-	2,606
Jarvis Memorial Private Investment Trust 1	10,147	4	651	647	-	647
Mastern Private Private Invetstment Trust 68	18,620	-	878	877	-	877
Vestas Qualified Investors Private Real Estate Fund Investment Trust No.37	59,422	20	6,374	1,224	-	1,224
Milestone Private Real Estate Fund 3	57,792	2	7,083	6,797	-	6,797
IGIS Private Real Estate Investment Trust 286	74,406	53,065	5,298	696	-	696
Nomura-Rifa Private Real Estate Investment Trust 31	98,291	71,442	7,584	1,356	-	1,356
SHBNPP Senior Loan Professional Investment Type Private Mixed Asset Investment Trust No.2	62,682	45	6,511	6,169	-	6,169

SHINHAN FINANCIAL GROUP CO., LTD. AND SUBSIDIARIES

Notes to the Consolidated Financial Statements

December 31, 2021 and 2020

(In millions of won)

15. Investments in associates (continued)

(c) The statement of financial information as of and for the years ended December 31, 2021 and 2020 are as follows (continued):

Investees	December 31, 2020					
	Asset	Liability	Operating revenue	Net profit (loss)	Other comprehensive income (loss)	Total comprehensive income (loss)
Hana Semiconductor New Technology Fund	₩ 111,661	12,346	70,303	56,926	-	56,926
J&Magnet Startup Venture Specialized Private Equity Fund	24,381	50	8,291	8,638	-	8,638
Cape IT Fund No.3	32,448	75	4,145	3,837	-	3,837
FuturePlay-Shinhan TechInnovation Fund 1	8,621	31	5	(469)	-	(469)
Stonebridge Corporate 1st Fund	7,342	1	679	584	-	584
Vogo Realty Partners Private Real Estate Fund V	50,139	99	8,137	4,701	-	4,701
Korea Credit Bureau	114,571	37,062	93,275	3,992	-	3,992
Goduck Gangil1 PFV Co., Ltd	334,349	348,276	-	(10,065)	-	(10,065)
SBC PFV Co., Ltd	119,994	7,199	-	(7,169)	-	(7,169)
NH-amundi global infra private fund 16	87,908	230	20,499	(6,215)	-	(6,215)
IMM Global Private Equity Fund	367,570	1,368	17,222	2,995	-	2,995
HANA Alternative Estate Professional Private122	39,449	38	6,836	5,487	-	5,487
Hanwha-Incus Plus New Technology Fund No.1	25,860	-	13,169	12,961	-	12,961
SHBNPP Corporate Professional Investment Type Private Security Investment Trust No.7[Bond]	198,644	87,218	4,479	3,329	-	3,329
SHBNPP BNCT Professional Investment Type Private Special Asset Investment Trust	395,815	-	14,737	11,688	-	11,688
PSA EMP Private Equity Fund	33,953	97	8	(393)	-	(393)
Deutsche Global Professional Investment Type Private Real Estate Investment Trust No. 24	57,026	784	13,342	339	-	339
BRAIN DO PROFESSIONALE PRIVATE No. 27	11,827	12	1,414	1,292	-	1,292
UI Venture Fund 7th	13,466	21	2,044	1,145	-	1,145
Sparklabs-Shinhan Opportunity Fund 1	9,760	-	-	(340)	-	(340)
BNW Tech-Innovation Private Equity Fund	20,119	213	45	(194)	-	(194)
IGIS Real-estate Private Investment Trust No.33	88,319	53,812	1,570	378	-	378
Findvalue PreIPO 6th Professional Investment Type Private Investment Trust	9,505	-	5	5	-	5
WWG Global Real Estate Investment Trust no.4	60,083	12	8,431	2,971	-	2,971
Fidelis Global Private Real Estate Trust No.2	24,901	2	1,902	1,214	-	1,214
IGIS PRIVATE REAL ESTATE TRUST NO.331	57,655	45,417	20	(388)	-	(388)
AIP EURO PRIVATE REAL ESTATE TRUST No. 12	173,538	783	40,882	13,425	-	13,425
Pebblestone CGV Private Real Estate Trust No.1	63,907	36,405	7,451	1,141	-	1,141
Shinhan AIM Real Estate Fund No.2	75,018	138	7,611	(45,741)	-	(45,741)
Shinhan AIM Real Estate Fund No.1	223,471	28	22,855	7,284	-	7,284

SHINHAN FINANCIAL GROUP CO., LTD. AND SUBSIDIARIES

Notes to the Consolidated Financial Statements

December 31, 2021 and 2020

(In millions of won)

15. Investments in associates (continued)

(c) The statement of financial information as of and for the years ended December 31, 2021 and 2020 are as follows (continued) :

Investees	December 31, 2020					
	Asset	Liability	Operating revenue	Net profit (loss)	Other comprehensive income (loss)	Total comprehensive income (loss)
SHBNPP Daegu Green Power Cogeneration System Professional Investment Type Private Special Asset Investment Trust [Infra business]	₩ 149,686	75	3,342	3,117	-	3,117
SHBNPP Sangju YC Expressway Professional Investment Type Private Special Asset Investment Trust [Infra business]	71,774	169	4,948	(3,773)	-	(3,773)
SHBNPP Global Infrastructure Professional Investment Type Private Special Asset Investment Trust No.7-2	9,380	12	576	(814)	-	(814)
SHBNPP Japan Photovoltaic Private Special Asset Investment Trust No. 1 [Equity securities-Derivative]	61,389	45,239	47,240	(46)	-	(46)
Korea Omega-Shinhan Project Fund I	11,861	-	-	(139)	-	(139)
New Green Shinhan Mezzanine Fund	12,538	1	2,387	2,337	-	2,337
KORAMKO-Daum Professional Private Investment Trust No.12	22,740	157	1,949	1,792	-	1,792
Samsung SRA Real Estate Professional Private 45[FoFs]	42,895	230	4,155	(355)	-	(355)
IBK Global New Renewable Energy Special Asset Professional Private2	116,284	4,679	19,514	10,943	-	10,943
VS Cornerstone Fund	8,413	-	2	(87)	-	(87)
Aone Mezzanine Opportunity Professional Private	14,530	40	2,507	2,390	-	2,390
KiwoomUnicorn3New Technology Business Investment Fund	20,132	-	6,112	6,031	-	6,031
Multi Asset The United States Thortons Professional Private1	165,775	15	2,111	671	-	671
Kiwoom Milestone US Real Estate Professional Private20	68,591	157	3,508	2,286	-	2,286
NH-Amundi US Infrastructure Private Fund2	99,409	1,248	16,758	3,025	-	3,025
KB Distribution Private Real Estate1	50,013	500	1,174	1,151	-	1,151
SHBNPP Jigae Namsan BTO professional Investment Type Private Special Asset Investment Trust [Infra business]	71,647	54	2,677	2,571	-	2,571
SHBNPP Japan Photovoltaic Private Special Asset Investment Trust No.2 [Loan-Derivative]	97,412	248	5,176	2,993	-	2,993
Kakao-Shinhan 1st TNYT Fund	12,014	331	2	(657)	-	(657)
IMM Special Situation 1-2 PRIVATE EQUITY FUND	54,328	33	4,378	4,344	-	4,344
Pacific Private Placement Real Estate Fund No.40	145,123	98,029	2,554	1,511	-	1,511
Mastern Private Real Estate Loan Fund No.2	17,156	201	98	(143)	-	(143)
LB Scotland Amazon Fulfillment Center Fund 29	44,483	28	1,975	612	-	612
JR AMC Hungary Budapest Office Fund 16	38,581	1,112	2,531	2,531	-	2,531

SHINHAN FINANCIAL GROUP CO., LTD. AND SUBSIDIARIES

Notes to the Consolidated Financial Statements

December 31, 2021 and 2020

(In millions of won)

15. Investments in associates (continued)

(c) The statement of financial information as of and for the years ended December 31, 2021 and 2020 are as follows (continued) :

Investees	December 31, 2020					
	Asset	Liability	Operating revenue	Net profit (loss)	Other comprehensive income (loss)	Total comprehensive income (loss)
IGIS 372 Real Estate Professional Private	₩ 628,769	428,577	10,221	(4,808)	-	(4,808)
KoFC-Neoplux R&D-Biz Creation 2013-1 Venture Capital Fund	18,460	2,824	1,673	240	-	240
Future-Creation Neoplux Venture Capital Fund	27,271	4,137	7,270	4,300	-	4,300
Gyeonggi-Neoplux Superman Fund	31,898	186	533	(212)	-	(212)
NewWave 6th Fund	20,501	-	2,757	1,528	-	1,528
Neoplux No.3 Private Equity Fund	103,712	756	9,114	(7,108)	-	(7,108)
PCC Amberstone Private Equity Fund I	104,930	1,194	12,280	5,501	-	5,501
KIAMCO POWERLOAN TRUST 4TH	92,817	23	815	1,193	-	1,193
Mastern Opportunity Seeking Real Estate Fund II	99,087	93	1,391	1,453	-	1,453
AION ELFIS PROFESSIONAL PRIVATE 1	27,672	30	2,710	2,642	-	2,642
T&F 2020 SS Private Equity Fund Specializing in Start-up and Venture Business	15,074	73	-	(160)	-	(160)
Neoplux Market-Frontier Secondary Fund	56,363	1,636	1,359	(339)	-	(339)
Synergy Green New Deal 1st New Technology Business Investment Fund	35,539	12	39	27	-	27
KAIM Real-estate Private Investment Trust 20	13,254	-	254	254	-	254
KIAMCO Vietnam Solar Special Asset Private Investment Trust	15,902	6	-	(404)	-	(404)
CSQUARE SNIPER PROFESSIONAL PRIVATE 10	5,010	10	10	-	-	-
IGIS GLIP Professional Investment Private Real Estate Investment Trust No. 1-1	45,582	9	-	(9)	-	(9)
IGIS GLIP Professional Investment Private Real Estate Investment Trust No. 1-2	45,582	9	-	(9)	-	(9)
Pacific Sunny Professional Investors Private Placement Real Estate Investment Company No.45	141,811	93,336	1	1,290	-	1,290
IGIS Professional Investors Private Investment Real Estate Investment LLC No.395	116,853	66,459	-	(605)	-	(605)
SHBNPP Green New Deal Energy Professional Investment Type Private Special Asset Investment Trust No.2	70,487	14	194	180	-	180
Kiwoom Private Equity Ant-Man Startup Venture Specialized Private Equity Fund	20,174	40	4,210	4,134	-	4,134
Kiwoom Hero No.4 Private Equity Fund	22,359	1	-	3,358	-	3,358
Vogo Canister Professional Trust Private Fund I	119,968	76	17,022	4,148	-	4,148

(*) Excluded the financial information of associates that are not subject to equity method due to disposal or of which the financial information is not available as of end of the year.

SHINHAN FINANCIAL GROUP CO., LTD. AND SUBSIDIARIES

Notes to the Consolidated Financial Statements

December 31, 2021 and 2020

(In millions of won)

15. Investments in associates (continued)

(d) Reconciliation of the financial information to the carrying value of its interests in the associates as of December 31, 2021 and 2020 are as follows:

Investees	December 31, 2021					
	Net assets (a)	Ownership (%)(b)	Interests in the net assets (a)*(b)	Intra-group transactions	Other	Carrying amount
BNP Paribas Cardif Life Insurance	₩ 293,634	14.99	44,039	(17)	-	44,022
Songrim Partners(*1)	(62)	35.34	(22)	-	22	-
Partners 4th Growth Investment Fund	52,134	25.00	13,033	-	-	13,033
KTB Newlake Global Healthcare PEF(*1)	30,808	30.00	9,299	-	113	9,412
Shinhan-Neoplux Energy Newbiz Fund	65,211	31.66	16,032	-	-	16,032
Shinhan-Albatross tech investment Fund	20,213	50.00	10,389	-	-	10,389
VOGO Debt Strategy Qualified IV Private	35,896	20.00	7,179	-	-	7,179
Shinhan-Midas Donga Secondary Fund	7,902	50.00	3,951	-	-	3,951
ShinHan – Soo Young Entrepreneur Investment Fund No.1	17,608	24.00	4,226	-	-	4,226
Shinhan Praxis K-Growth Global Private Equity Fund	41,133	18.87	7,761	-	-	7,761
Kiwoom Milestone Professional Private Real Estate Trust 19	10,505	50.00	5,253	-	-	5,253
AIP EURO Green Private Real Estate Trust No.3	139,576	21.28	29,703	-	-	29,703
Shinhan Global Healthcare Fund I(*1)	(3,464)	4.41	(153)	-	153	-
KB NA Hickory Private Special Asset Fund	91,668	37.50	34,376	-	-	34,376
Koramco Europe Core Private Placement Real Estate Fund No.2-2	44,275	44.02	19,492	-	-	19,492
BNP Paribas Cardif General Insurance	61,431	5.46	3,354	-	-	3,354
Hermes Private Investment Equity Fund	33,537	29.17	9,782	-	-	9,782
Shinhan-Nvestor Liquidity Solution Fund	21,420	24.92	5,338	-	-	5,338
Shinhan AIM FoF Fund 1a	36,623	25.00	9,156	-	-	9,156
IGIS Global Credit Fund 150-1	21,609	25.00	5,402	-	-	5,402
Partner One Value up I Private Equity Fund	28,273	27.91	7,891	-	-	7,891
Genesis No.1 Private Equity Fund	243,534	22.80	55,533	-	-	55,533
Korea Omega Project Fund III	18,234	23.53	4,290	-	-	4,290
Soo Delivery Platform Growth Fund	19,578	30.00	5,873	-	-	5,873
Genesis North America Power Company No.1 PEF	34,310	40.03	13,736	-	-	13,736
SH MAIN Professional Investment Type Private Mixed Asset Investment Trust No.3	178,069	23.33	41,549	-	-	41,549
Korea Finance Security	20,078	14.91	2,994	-	-	2,994
MIEL CO.,LTD.(*1)	(141)	28.77	(41)	-	41	-

SHINHAN FINANCIAL GROUP CO., LTD. AND SUBSIDIARIES

Notes to the Consolidated Financial Statements

December 31, 2021 and 2020

(In millions of won)

15. Investments in associates (continued)

(d) Reconciliation of the financial information to the carrying value of its interests in the associates as of December 31, 2021 and 2020 are as follows (continued):

Investees	December 31, 2021						Carrying amount
	Net assets (a)	Ownership (%) (b)	Interests in the net assets (a)*(b)	Intra-group transactions	Other		
AIP Transportation Specialized Privately Placed Fund Trust #1	₩ 97,097	35.73	34,688	-	-	34,688	
E&Healthcare Investment Fund No.6	32,615	21.05	6,866	-	-	6,866	
One Shinhan Global Fund 1	15,758	20.56	3,773	-	-	3,773	
Kiwoom-Shinhan Innovation Fund I	23,462	50.00	11,731	-	-	11,731	
Daishin-K&T New Technology Investment Fund	25,571	31.25	7,991	-	-	7,991	
Midas Asset Global CRE Debt Private Fund No.6	117,347	41.16	48,305	-	-	48,305	
Samchully Midstream Private Placement Special Asset Fund 5-4	65,931	42.92	27,471	-	-	27,471	
SH Senior Loan Professional Investment Type Private Mixed Asset Investment Trust No.3	126,020	20.00	25,204	-	-	25,204	
NH-Amundi Global Infrastructure Trust 14	61,004	30.00	18,301	-	-	18,301	
Jarvis Memorial Private Investment Trust 1	10,210	99.01	10,109	-	-	10,109	
Vestas Qualified Investors Private Real Estate Fund Investment Trust No.37	55,254	60.00	33,153	-	-	33,153	
Milestone Private Real Estate Fund 3	57,842	32.06	18,544	-	-	18,544	
Nomura-Rifa Private Real Estate Investment Trust 31	25,108	31.31	7,902	-	-	7,902	
SH Senior Loan Professional Investment Type Private Mixed Asset Investment Trust No.2	48,124	21.27	10,236	-	-	10,236	
Cape IT Fund No.3	30,599	32.89	10,065	-	-	10,065	
FuturePlay-Shinhan TechInnovation Fund 1	14,297	50.00	7,149	-	-	7,149	
Stonebridge Corporate 1st Fund	6,718	44.12	2,964	-	-	2,964	
Vogo Realty Partners Private Real Estate Fund V	49,760	21.64	10,766	-	-	10,766	
Korea Credit Bureau	85,497	9.00	7,695	-	-	7,695	
Goduck Gangil1 PFV Co., Ltd>(*1)	(15,763)	1.04	(164)	-	164	-	
SBC PFV Co., Ltd.(*1)	158,286	25.00	34,581	-	(4,995)	29,586	
NH-amundi global infra private fund 16	104,016	50.00	52,008	-	-	52,008	
IMM Global Private Equity Fund	359,415	33.00	118,615	-	-	118,615	
HANA Alternative Estate Professional Private122	39,840	74.02	29,489	-	-	29,489	
SH Corporate Professional Investment Type Private Security Investment Trust No.7	100,098	45.96	49,899	-	-	49,899	
SH BNCT Professional Investment Type Private Special Asset Investment Trust	389,240	72.50	282,199	-	-	282,199	
Deutsche Global Professional Investment Type Private Real Estate Investment Trust No. 24	54,158	52.28	28,312	-	-	28,312	
BRAIN DO PROFESSIONALE PRIVATE No. 27	3,351	29.13	976	-	-	976	
Sparklabs-Shinhan Opportunity Fund 1	9,372	49.50	4,640	-	-	4,640	
BNW Tech-Innovation Private Equity Fund	19,702	29.85	5,881	-	-	5,881	

SHINHAN FINANCIAL GROUP CO., LTD. AND SUBSIDIARIES

Notes to the Consolidated Financial Statements

December 31, 2021 and 2020

(In millions of won)

15. Investments in associates (continued)

(d) Reconciliation of the financial information to the carrying value of its interests in the associates as of December 31, 2021 and 2020 are as follows (continued):

Investees	December 31, 2021					
	Net assets (a)	Ownership (%)(b)	Interests in the net assets (a)*(b)	Intra-group transactions	Other	Carrying amount
IGIS Real-estate Private Investment Trust No.33	₩ 33,982	40.86	13,884	-	-	13,884
WWG Global Real Estate Investment Trust no.4	36,019	29.55	10,644	-	-	10,644
Goduck Gangil10 PFV Co., Ltd(*1)	(8,362)	19.90	(1,664)	-	1,664	-
Fidelis Global Private Real Estate Trust No.2	25,265	78.26	19,773	-	-	19,773
AIP EURO PRIVATE REAL ESTATE TRUST No. 12	171,489	28.70	49,217	-	-	49,217
Shinhan Healthcare Fund 2(*1)	(103)	13.68	(14)	-	14	-
Pebblestone CGV Private Real Estate Trust No.1	28,252	48.53	13,710	-	-	13,710
Shinhan AIM Real Estate Fund No.2	77,582	30.00	23,275	-	-	23,275
Shinhan AIM Real Estate Fund No.1	210,908	21.01	44,312	-	-	44,312
SH Daegu Green Power Cogeneration System Professional Investment Type Private Special Asset Investment Trust	149,627	22.02	32,948	-	-	32,948
SH Sangju YC Expressway Professional Investment Type Private Special Asset Investment Trust	70,401	29.19	20,550	-	-	20,550
SH Global Infrastructure Professional Investment Type Private Special Asset Investment Trust No.7-2(USD)	26,396	71.43	18,855	-	-	18,855
Korea Omega-Shinhan Project Fund I	14,488	50.00	7,244	-	-	7,244
ST-Bonanja Food tech	8,650	38.83	3,359	-	-	3,359
Samsung SRA Real Estate Professional Private 45	51,519	25.00	12,880	-	-	12,880
IBK Global New Renewable Energy Special Asset Professional Private2	110,012	28.98	31,887	-	-	31,887
VS Cornerstone Fund	8,281	41.18	3,410	-	-	3,410
Aone Mezzanine Opportunity Professional Private	14,447	66.09	9,540	-	-	9,540
NH-Amundi US Infrastructure Private Fund2	104,313	25.91	27,024	-	-	27,024
KB Distribution Private Real Estate1	49,506	62.00	30,694	-	-	30,694
SH Jigae Namsan BTO professional Investment Type Private Special Asset Investment Trust	43,385	30.00	13,016	-	-	13,016
Kakao-Shinhan 1st TNYT Fund	29,815	48.62	14,497	-	-	14,497
IMM Special Situation 1-2 PRIVATE EQUITY FUND	57,962	20.00	11,593	-	-	11,593
Pacific Private Placement Real Estate Fund No.40	46,898	24.73	11,598	-	-	11,598
Mastern Private Real Estate Loan Fund No.2	22,314	33.57	7,491	-	-	7,491
LB Scotland Amazon Fulfillment Center Fund 29	44,577	70.14	31,268	-	-	31,268
JR AMC Hungary Budapest Office Fund 16	37,274	32.57	12,140	-	-	12,140
EDNCENTRAL Co.,Ltd.(*1)	(2,487)	19.87	(494)	-	494	-
Future-Creation Neoplux Venture Capital Fund	18,569	16.25	3,017	-	-	3,017
Gyeonggi-Neoplux Superman Fund	36,195	21.76	7,878	-	-	7,878

SHINHAN FINANCIAL GROUP CO., LTD. AND SUBSIDIARIES

Notes to the Consolidated Financial Statements

December 31, 2021 and 2020

(In millions of won)

15. Investments in associates (continued)

(d) Reconciliation of the financial information to the carrying value of its interests in the associates as of December 31, 2021 and 2020 are as follows (continued):

Investees	December 31, 2021					
	Net assets (a)	Ownership (%)(b)	Interests in the net assets (a)*(b)	Intra-group transactions	Other	Carrying amount
NewWave 6th Fund	₩ 48,185	30.00	14,455	-	-	14,455
KTC-NP Growth Champ 2011-2 Private Equity Fund	71,829	5.56	3,990	-	-	3,990
Neoplux No.3 Private Equity Fund	226,008	10.00	22,601	-	-	22,601
PCC Amberstone Private Equity Fund I	105,169	21.67	22,790	-	-	22,790
KIAMCO POWERLOAN TRUST 4TH	95,634	47.37	45,301	-	-	45,301
Mastern Opportunity Seeking Real Estate Fund II	106,584	20.00	21,317	-	-	21,317
AION ELFIS PROFESSIONAL PRIVATE 1	22,112	20.00	4,422	-	-	4,422
T&F 2020 SS Private Equity Fund Specializing in Start-up and Venture Business	14,688	29.68	4,360	-	-	4,360
Neoplux Market-Frontier Secondary Fund	57,319	19.74	11,313	-	-	11,313
Harvest Private Equity Fund II	15,780	22.06	3,481	-	-	3,481
Synergy Green New Deal 1st New Technology Business Investment Fund	34,379	28.17	9,684	-	-	9,684
KAIM Real-estate Private Investment Trust 20	13,125	38.46	5,048	-	-	5,048
KIAMCO Vietnam Solar Special Asset Private Investment Trust	15,053	50.00	7,527	-	-	7,527
Daishin New Technology Investment Fund 5th	18,940	23.44	4,439	-	-	4,439
CSQUARE SNIPER PROFESSIONAL PRIVATE 10	5,194	62.50	3,247	-	-	3,247
Acurus Hyundai Investment Partners New Technology	17,600	26.79	4,714	-	-	4,714
IGIS GLIP Professional Investment Private Real Estate Investment Trust No. 1-1	60,681	97.10	63,944	-	-	63,944
IGIS GLIP Professional Investment Private Real Estate Investment Trust No. 1-2	60,681	97.10	63,944	-	-	63,944
Pacific Sunny Professional Investors Private Placement Real Estate Investment Company No.45	40,385	25.00	14,778	-	-	14,778
SHINHAN-NEO Core Industrial Technology Fund	11,439	49.75	5,691	-	-	5,691
SHBNPP Green New Deal Energy Professional Investment Type Private Special Asset Investment Trust No.2	90,810	30.00	27,243	-	-	27,243
SIMONE Mezzanine Fund No.3	10,395	29.38	3,054	-	-	3,054
Eum Private Equity Fund No.7	37,495	21.00	7,873	-	-	7,873
Kiwoom Private Equity Ant-Man Startup Venture Specialized Private Equity Fund	30,375	25.00	7,594	-	-	7,594
Kiwoom Hero No.4 Private Equity Fund	20,449	21.05	4,305	-	-	4,305
Vogo Canister Professional Trust Private Fund I	112,433	36.53	41,072	-	-	41,072
SW-S Fund	22,191	30.30	6,724	-	-	6,724
CL Buyout 1st PEF	64,359	21.43	13,791	-	-	13,791
Timefolio The Venture-V second	22,060	20.73	4,572	-	-	4,572
Newlake Growth Capital Partners2 PEF	43,187	29.91	12,921	-	-	12,921

SHINHAN FINANCIAL GROUP CO., LTD. AND SUBSIDIARIES

Notes to the Consolidated Financial Statements

December 31, 2021 and 2020

(In millions of won)

15. Investments in associates (continued)

(d) Reconciliation of the financial information to the carrying values of its interests in the associates as of December 31, 2021 and 2020 are as follows (continued):

Investees	December 31, 2021					
	Net assets (a)	Ownership (%)(b)	Interests in the net assets (a)*(b)	Intra-group transactions	Other	Carrying amount
Shinhan Smilegate Global PEF I	₩ 23,469	14.21	3,336	-	-	3,336
Fount Professional Investors Private Investment Trust No.3	10,399	49.98	5,197	-	-	5,197
Genesis Eco No.1 PEF	38,365	29.01	11,130	-	-	11,130
SHINHAN-NEO Market-Frontier 2nd Fund	57,625	42.70	24,606	-	-	24,606
NH-Synergy Core Industrial New Technology Fund	17,430	36.93	6,437	-	-	6,437
J& Moorim Jade Investment Fund	22,259	24.89	5,540	-	-	5,540
Ulmus SHC innovation investment fund	21,601	24.04	5,192	-	-	5,192
Mirae Asset Partners X Private Equity Fund	22,002	35.71	7,858	-	-	7,858
T Core Industrial Technology 1st Venture PEF	14,413	31.47	4,535	-	-	4,535
Curious Finale Corporate Recovery Private Equity Fund	13,285	27.78	3,690	-	-	3,690
TI First Property Private Investment Trust 1	7,637	40.00	3,055	-	-	3,055
MPLUS Professional Private Real Estate Fund 25	7,896	41.67	3,290	-	-	3,290
IBKC Global Contents Investment Fund	20,265	24.39	4,943	-	-	4,943
Nautic Smart No.6 Private Equity Fund	10,533	37.74	3,974	-	-	3,974
Premier Luminous Private Equity Fund	25,167	27.78	6,991	-	-	6,991
Hanyang-Meritz 1 Fund	15,423	22.58	3,483	-	-	3,483
KNT 2ND PRIVATE EQUITY FUND	19,124	21.74	4,157	-	-	4,157
Maple Mobility Fund	43,023	20.18	8,683	-	-	8,683
AVES 1st Corporate Recovery Private Equity Fund	6,215	76.19	4,736	-	-	4,736
JS Shinhan Private Equity Fund	130,966	3.85	5,037	-	-	5,037
Daishin Newgen New Technology Investment Fund 1 st	24,048	50.60	12,169	-	-	12,169
META ESG Private Equity Fund I	21,722	27.40	5,677	-	-	5,677
SWFV FUND-1	23,965	40.25	9,646	-	-	9,646
PHAROS DK FUND	16,289	24.24	3,949	-	-	3,949
Shinhan VC tomorrow venture fund 1	22,603	39.62	9,042	-	-	9,042
Highland 2021-8 Fund	14,998	32.67	4,899	-	-	4,899
Medicii 2021-3 Fund	39,202	24.81	9,728	-	-	9,728
Tres-Yujin Trust	19,989	50.00	9,995	-	-	9,995
Shinhan-Time mezzanine blind Fund	29,885	50.00	14,942	-	-	14,942
Capstone REITs No.26	8,790	50.00	4,395	-	-	4,395
JB Incheon-Bucheon REITS No.54	12,716	39.31	4,999	-	-	4,999
Hankook Smart Real Asset Investment Trust No.3	13,026	33.33	4,342	-	-	4,342
JB Hwaseong-Hadong REITs No.53	16,111	31.03	4,999	-	-	4,999
KB Oaktree Trust No.3	9,475	33.33	3,159	-	-	3,159
Daehan No.36 Office Asset Management Company(*1)	37,891	48.05	18,206	-	3,294	21,500
Rhinos Premier Mezzanine Private Investment Fund No.1	10,759	27.93	3,005	-	-	3,005
SH Real Estate Loan Investment Type Private Real Estate Investment Trust No.2	66,947	29.73	19,903	-	-	19,903
Shinhan JigaeNamsan Road Private Special Asset Investment Trust	161,390	24.85	40,105	-	-	40,105
SKS-Yozma Fund No.1	19,915	29.85	5,945	-	-	5,945
Others	666,941	-	367,840	-	1,492	369,332
	₩ 8,508,993	-	2,911,306	(17)	2,456	2,913,745

(*1) Other represents the adjustments of fair value when acquired.

(*2) The adjustments for others are the unrecognized equity method for preferred stocks without voting rights issued by the invested company.

SHINHAN FINANCIAL GROUP CO., LTD. AND SUBSIDIARIES

Notes to the Consolidated Financial Statements

December 31, 2021 and 2020

(In millions of won)

15. Investments in associates (continued)

(d) Reconciliation of the financial information to the carrying values of its interests in the associates as of December 31, 2021 and 2020 are as follows (continued):

Investees	December 31, 2020					
	Net assets (a)	Ownership (%)(b)	Interests in the net assets (a)*(b)	Intra-group transactions	Other	Carrying amount
BNP Paribas Cardif Life Insurance	₩ 337,586	14.99	50,632	(32)	-	50,600
Songrim Partners(*1)	(62)	35.34	(22)	-	22	-
Partners 4th Growth Investment Fund	47,832	25.00	11,958	-	-	11,958
KTB Newlake Global Healthcare PEF(*2)	30,780	30.00	9,234	-	170	9,404
Daekwang Semiconductor Co., Ltd.	17,343	20.94	3,631	-	-	3,631
Shinhan-Neoplux Energy Newbiz Fund	44,590	31.66	14,470	-	-	14,470
Shinhan-Albatross tech investment Fund	27,300	49.97	13,322	-	-	13,322
Eum Private Equity Fund No.3	16	20.76	3	-	-	3
Meritz AI-SingA330-A Investment Type Private Placement Special Asset Fund	-	23.89	-	-	-	-
Meritz AI-SingA330-B Investment Type Private Placement Special Asset Fund	-	20.16	-	-	-	-
VOGO Debt Strategy Qualified INV Private	43,512	20.00	8,702	-	-	8,702
Shinhan-Midas Donga Secondary Fund	9,504	50.00	4,752	-	-	4,752
ShinHan – Soo Young Entrepreneur Investment Fund No.1	41,532	24.00	9,968	-	-	9,968
Shinhan Praxis K-Growth Global Private Equity Fund	52,707	18.87	9,945	-	-	9,945
Credian Healthcare Private Equity Fund II	17,126	34.07	5,835	-	-	5,835
Kiwoom Milestone Professional Private Real Estate Trust 19	19,835	50.00	9,918	-	-	9,918
AIP EURO Green Private Real Estate Trust No.3	98,780	21.28	21,021	-	-	21,021
Hanhwa US Equity Strategy Private Real Estate Fund No.1	5,077	44.84	2,277	-	-	2,277
Shinhan Global Healthcare Fund I(*1)	(2,049)	4.41	(90)	-	90	-
JB Power TL Investment Type Private Placement Special Asset Fund 7	48,560	33.33	16,186	-	-	16,186
KB NA Hickory Private Special Asset Fund	93,167	37.50	34,938	-	-	34,938
Koramco Europe Core Private Placement Real Estate Fund No.2-2	42,291	44.02	18,618	-	-	18,618
BNP Paribas Cardif General Insurance	52,215	7.46	3,895	-	-	3,895
Hermes Private Investment Equity Fund	20,911	29.17	6,099	-	-	6,099
Shinhan-Nvestor Liquidity Solution Fund	18,032	24.92	4,493	-	-	4,493
Shinhan AIM FoF Fund 1a	35,040	25.00	8,760	-	-	8,760
IGIS Global Credit Fund 150-1	29,129	25.00	7,282	-	-	7,282
Soo Commerce Platform Growth Fund	4,658	24.62	1,147	-	-	1,147
Partner One Value up I Private Equity Fund	42,205	27.91	11,779	-	-	11,779
Genesis No.1 Private Equity Fund	351,329	22.80	80,113	-	-	80,113

SHINHAN FINANCIAL GROUP CO., LTD. AND SUBSIDIARIES

Notes to the Consolidated Financial Statements

December 31, 2021 and 2020

(In millions of won)

15. Investments in associates (continued)

(d) Reconciliation of the financial information to the carrying values of its interests in the associates as of December 31, 2021 and 2020 are as follows (continued):

Investees	December 31, 2020					
	Net assets (a)	Ownership (%)(b)	Interests in the net assets (a)*(b)	Intra-group transactions	Other	Carrying amount
Korea Omega Project Fund III	₩ 15,141	23.53	3,563	-	-	3,563
Soo Delivery Platform Growth Fund	13,560	30.00	4,068	-	-	4,068
Genesis North America Power Company No.1 PEF	42,494	39.96	16,983	-	-	16,983
Hyungje art printing(*1)	(264)	31.54	(83)	-	83	-
SHBNPP MAIN Professional Investment Type Private Mixed Asset Investment Trust No.3	45,350	23.33	10,582	-	-	10,582
Shinhan-Rhinos 1 Fund	11,560	22.48	2,599	-	-	2,599
Pacific Private Investment Trust No.20	13,794	21.74	2,999	-	-	2,999
Susung Mezzanine project P1 Private Investment Trust	3,220	41.31	1,345	-	-	1,345
Korea Finance Security	20,490	14.91	3,055	-	-	3,055
Multimedia Tech Co.Ltd.(*1)	(69)	21.06	(15)	-	15	-
MIEL CO.,LTD(*1)	(85)	28.77	(25)	-	25	-
AIP Transportation Specialized Privately Placed Fund Trust #1	92,353	35.73	32,993	-	-	32,993
DB Epic Convertiblebond Private Trust No.2	11,348	50.98	5,785	-	-	5,785
E&Healthcare Investment Fund No.6	72,023	21.05	15,163	-	-	15,163
One Shinhan Global Fund1	22,244	19.96	4,029	-	-	4,029
Kiwoom-Shinhan Innovation Fund I	31,938	50.00	15,969	-	-	15,969
Daishin-K&T New Technology Investment Fund	22,400	31.25	7,000	-	-	7,000
Midas Asset Global CRE Debt Private Fund No.6	115,122	41.16	47,389	-	-	47,389
Richmond Private Investment Trust No.82	25,082	60.00	15,049	-	-	15,049
Tiger Alternative Real Estate Professional Private5	37,978	48.71	18,499	-	-	18,499
Samchully Midstream Private Placement Special Asset Fund 5-4	67,141	42.92	28,818	-	-	28,818
SHBNPP Senior Loan Professional Investment Type Private Mixed Asset Investment Trust No.3	327,917	20.00	65,616	-	-	65,616
NH-Amundi Global Infrastructure Trust 14	62,728	30.00	18,819	-	-	18,819
Jarvis Memorial Private Investment Trust 1	10,143	99.01	10,043	-	-	10,043
Masterm Private Private Investment Trust 68	18,620	53.76	10,010	-	-	10,010
Vestas Qualified Investors Private Real Estate Fund Investment Trust No.37	59,402	60.00	35,641	-	-	35,641
Milestone Private Real Estate Fund 3	57,790	32.06	18,528	-	-	18,528
IGIS Private Real Estate Investment Trust 286	21,341	41.44	8,844	-	-	8,844
Nomura-Rifa Private Real Estate Investment Trust 31	26,849	31.31	8,407	-	-	8,407
SHBNPP Senior Loan Professional Investment Type Private Mixed Asset Investment Trust No.2	62,637	21.27	13,323	-	-	13,323

SHINHAN FINANCIAL GROUP CO., LTD. AND SUBSIDIARIES

Notes to the Consolidated Financial Statements

December 31, 2021 and 2020

(In millions of won)

15. Investments in associates (continued)

(d) Reconciliation of the financial information to the carrying values of its interests in the associates as of December 31, 2021 and 2020 are as follows (continued):

Investees	December 31, 2020					
	Net assets (a)	Ownership (%)(b)	Interests in the net assets (a)*(b)	Intra-group transactions	Other	Carrying amount
Hana Semiconductor New Technology Fund ₩	99,315	24.30	24,131	-	-	24,131
J&Magnet Startup Venture Specialized Private Equity Fund	24,331	24.39	5,935	-	-	5,935
Cape IT Fund No.3	32,373	32.89	10,649	-	-	10,649
FuturePlay-Shinhan TechInnovation Fund 1	8,590	50.00	4,295	-	-	4,295
Stonebridge Corporate 1st Fund	7,341	44.12	3,239	-	-	3,239
Vogo Realty Partners Private Real Estate Fund V	50,040	21.64	10,827	-	-	10,827
Korea Credit Bureau	77,509	9.00	6,976	-	-	6,976
Goduck Gangil PFV Co., Ltd(*1)	(13,927)	1.04	(145)	-	145	-
SBC PFV Co., Ltd	112,795	25.00	18,208	-	-	18,208
NH-amundi global infra private fund 16	87,678	50.00	43,839	-	-	43,839
IMM Global Private Equity Fund	366,202	33.00	120,855	-	-	120,855
HANA Alternative Estate Professional Private122	39,411	75.19	29,631	-	-	29,631
Hanwha-Incus Plus New Technology Fund No.1	25,860	42.64	11,026	-	-	11,026
SHBNPP Corporate Professional Investment Type Private Security Investment Trust No.7[Bond]	111,426	45.96	51,210	-	-	51,210
SHBNPP BNCT Professional Investment Type Private Special Asset Investment Trust	395,815	72.39	286,531	-	-	286,531
PSA EMP Private Equity Fund	33,856	28.99	9,814	-	-	9,814
Deutsche Global Professional Investment Type Private Real Estate Investment Trust No. 24	56,242	52.28	29,401	-	-	29,401
BRAIN DO PROFESSIONALE PRIVATE No. 27	11,815	29.13	3,441	-	-	3,441
UI Venture Fund 7th	13,445	24.39	3,279	-	-	3,279
Sparklabs-Shinhan Opportunity Fund 1	9,760	49.50	4,832	-	-	4,832
BNW Tech-Innovation Private Equity Fund	19,906	29.85	5,942	-	-	5,942
IGIS Real-estate Private Investment Trust No.33	34,507	40.86	14,099	-	-	14,099
Findvalue PreIPO 6th Professional Investment Type Private Investment Trust.	9,505	31.58	3,002	-	-	3,002
WWG Global Real Estate Investment Trust no.4	60,071	29.55	17,752	-	-	17,752
Fidelis Global Private Real Estate Trust No.2	24,899	78.26	19,485	-	-	19,485
IGIS PRIVATE REAL ESTATE TRUST NO.331	12,238	30.77	3,765	-	-	3,765
AIP EURO PRIVATE REAL ESTATE TRUST No. 12	172,755	28.70	48,344	-	-	48,344
Pebblestone CGV Private Real Estate Trust No.1	27,502	48.53	13,346	-	-	13,346
Shinhan AIM Real Estate Fund No.2	74,880	30.00	22,464	-	-	22,464
Shinhan AIM Real Estate Fund No.1	223,443	21.01	46,945	-	-	46,945

SHINHAN FINANCIAL GROUP CO., LTD. AND SUBSIDIARIES

Notes to the Consolidated Financial Statements

December 31, 2021 and 2020

(In millions of won)

15. Investments in associates (continued)

(d) Reconciliation of the financial information to the carrying values of its interests in the associates as of December 31, 2021 and 2020 are as follows (continued):

Investees	December 31, 2020					
	Net assets (a)	Ownership (%)(b)	Interests in the net assets (a)*(b)	Intra-group transactions	Other	Carrying amount
SHBNPP Daegu Green Power Cogeneration System Professional Investment Type Private Special Asset Investment Trust [Infra business]	₩ 149,611	22.02	32,944	-	-	32,944
SHBNPP Sangju YC Expressway Professional Investment Type Private Special Asset Investment Trust [Infra business]	71,605	29.19	20,902	-	-	20,902
SHBNPP Global Infrastructure Professional Investment Type Private Special Asset Investment Trust No.7-2	9,368	71.43	6,692	-	-	6,692
SHBNPP Japan Photovoltaic Private Special Asset Investment Trust No. 1 [Equity securities-Derivative]	16,150	30.00	4,845	-	-	4,845
Korea Omega-Shinhan Project Fund I	11,861	50.00	5,931	-	-	5,931
New Green Shinhan Mezzanine Fund	12,537	39.22	4,916	-	-	4,916
KORAMKO-Daum Professional Private Investment Trust No.12	22,583	33.33	7,528	-	-	7,528
Samsung SRA Real Estate Professional Private 45[FoFs]	42,665	25.00	10,666	-	-	10,666
IBK Global New Renewable Energy Special Asset Professional Private2	111,605	28.98	32,349	-	-	32,349
VS Cornerstone Fund	8,413	41.18	3,464	-	-	3,464
Aone Mezzanine Opportunity Professional Private	14,490	66.12	9,580	-	-	9,580
KiwoomUnicorn3New Technology Business Investment Fund	20,132	21.28	4,283	-	-	4,283
Multi Asset The United States Thortons Professional Private1	165,760	25.00	41,440	-	-	41,440
Kiwoom Milestone US Real Estate Professional Private20	68,434	75.27	51,512	-	-	51,512
NH-Amundi US Infrastructure Private Fund2	98,161	25.91	25,430	-	-	25,430
KB Distribution Private Real Estate1	49,513	62.00	30,698	-	-	30,698
SHBNPP Jigae Namsan BTO professional Investment Type Private Special Asset Investment Trust	71,593	28.93	20,712	-	-	20,712
SHBNPP Japan Photovoltaic Private Special Asset Investment Trust No.2	97,164	30.00	29,149	-	-	29,149
Kakao-Shinhan 1st TNYT Fund	11,683	48.62	5,681	-	-	5,681
IMM Special Situation 1-2 PRIVATE EQUITY FUND	54,295	20.02	10,870	-	-	10,870
Pacific Private Placement Real Estate Fund No.40	47,094	24.73	11,647	-	-	11,647
Mastern Private Real Estate Loan Fund No.2	16,955	33.57	5,692	-	-	5,692
LB Scotland Amazon Fulfillment Center Fund 29	44,455	70.14	31,182	-	-	31,182
JR AMC Hungary Budapest Office Fund 16	37,469	32.57	12,204	-	-	12,204
IGIS 372 Real Estate Professional Private	200,192	28.39	56,835	-	-	56,835
KoFC-Neoplux R&D-Biz Creation 2013-1 Venture Capital Fund	15,636	19.00	3,830	-	-	3,830
Future-Creation Neoplux Venture Capital Fund	23,134	16.25	3,796	-	-	3,796
Gyeonggi-Neoplux Superman Fund	31,712	21.76	6,399	-	-	6,399
NewWave 6th Fund	20,501	30.00	6,150	-	-	6,150
Neoplux No.3 Private Equity Fund	102,956	10.00	10,295	-	-	10,295

SHINHAN FINANCIAL GROUP CO., LTD. AND SUBSIDIARIES

Notes to the Consolidated Financial Statements

December 31, 2021 and 2020

(In millions of won)

15. Investments in associates (continued)

(d) Reconciliation of the financial information to the carrying values of its interests in the associates as of December 31, 2021 and 2020 are as follows (continued):

Investees	December 31, 2020					
	Net assets (a)	Ownership (%)(b)	Interests in the net assets (a)*(b)	Intra-group transactions	Other	Carrying amount
PCC Amberstone Private Equity Fund I ₩	103,736	21.67	22,480	-	-	22,480
KIAMCO POWERLOAN TRUST 4TH	92,794	47.37	43,955	-	-	43,955
Masterm Opportunity Seeking Real Estate Fund II	98,994	20.00	19,799	-	-	19,799
AION ELFIS PROFESSIONAL PRIVATE I	27,642	20.00	5,528	-	-	5,528
T&F 2020 SS Private Equity Fund Specializing in Start-up and Venture Business	15,001	29.68	4,453	-	-	4,453
Neoplux Market-Frontier Secondary Fund	54,727	19.74	11,545	-	-	11,545
Synergy Green New Deal 1st New Technology Business Investment Fund	35,527	28.17	10,008	-	-	10,008
KAIM Real-estate Private Investment Trust 20	13,254	38.46	5,098	-	-	5,098
KIAMCO Vietnam Solar Special Asset Private Investment Trust	15,896	50.00	7,948	-	-	7,948
CSQUARE SNIPER PROFESSIONAL PRIVATE 10	5,000	62.50	3,125	-	-	3,125
IGIS GLIP Professional Investment Private Real Estate Investment Trust No. 1-1	45,573	97.85	44,594	-	-	44,594
IGIS GLIP Professional Investment Private Real Estate Investment Trust No. 1-2	45,573	97.85	44,594	-	-	44,594
Pacific Sunny Professional Investors Private Placement Real Estate Investment Company No.45	48,475	25.00	15,855	-	-	15,855
IGIS Professional Investors Private Investment Real Estate Investment LLC No.395	50,394	58.82	29,644	-	-	29,644
SHBNPP Green New Deal Energy Professional Investment Type Private Special Asset Investment Trust No.2	70,473	30.00	21,142	-	-	21,142
Kiwoom Private Equity Ant-Man Startup Venture Specialized Private Equity Fund	20,134	25.00	5,034	-	-	5,034
Kiwoom Hero No.4 Private Equity Fund	22,358	21.05	4,707	-	-	4,707
Vogo Canister Professional Trust Private Fund I	119,892	36.68	43,975	-	-	43,975
Others	519,091		139,164	-	-	139,164
₩	<u>8,101,037</u>		<u>2,657,250</u>	<u>(32)</u>	<u>550</u>	<u>2,657,768</u>

(*1) Other represents the adjustments of fair value when acquired.

(*2) The adjustments for others are the unrecognized equity method for preferred stocks without voting rights issued by the invested company.

SHINHAN FINANCIAL GROUP CO., LTD. AND SUBSIDIARIES

Notes to the Consolidated Financial Statements

December 31, 2021 and 2020

(In millions of won)

15. Investments in associates (continued)

(e) The unrecognized equity method losses as of and for the years ended December 31, 2021 and 2020 are as follows:

<u>Investees</u>	December 31, 2021	
	Unrecognized equity method losses	Cumulative unrecognized equity method losses
Songrim Partners.	₩ -	(22)
MIEL CO.,LTD	(16)	(41)
Goduck Gangil1 PFV Co., Ltd	(19)	(164)
Goduck Gangil10 PFV Co., Ltd	(1,664)	(1,664)
Shinhan Global Healthcare Fund 1	(153)	(153)
Shinhan Global Healthcare Fund 2	(14)	(14)
EDNCENTRAL Co.,Ltd.	(494)	(494)
	₩ <u>(2,360)</u>	<u>(2,552)</u>

<u>Investees</u>	December 31, 2020	
	Unrecognized equity method losses	Cumulative unrecognized equity method losses
Songrim Partners.	₩ -	(22)
Multimedia Tech Co.Ltd	(15)	(15)
Hyungje art printing	(83)	(83)
MIEL CO.,LTD	(25)	(25)
Goduck Gangil1 PFV Co., Ltd	(145)	(145)
	₩ <u>(268)</u>	<u>(290)</u>

SHINHAN FINANCIAL GROUP CO., LTD. AND SUBSIDIARIES

Notes to the Consolidated Financial Statements

December 31, 2021 and 2020

(In millions of won)

16. Investment properties

(a) Investment properties as of December 31, 2021 and 2020 are as follows:

	<u>December 31, 2021</u>	<u>December 31, 2020</u>
Acquisition cost	₩ 852,458	767,118
Accumulated depreciation	(177,067)	(151,883)
Carrying value	<u>₩ 675,391</u>	<u>615,235</u>

(b) Changes in investment properties for the years ended December 31, 2021 and 2020 are as follows:

	<u>December 31, 2021</u>	<u>December 31, 2020</u>
Beginning balance	₩ 615,235	488,610
Acquisition	8,292	244,100
Disposal	(2,279)	(92,337)
Depreciation	(21,616)	(20,165)
Amounts transferred from (to) property and equipment	73,773	(4,064)
Amounts transferred from(to) assets held for sale(*)	2,238	(910)
Foreign currency adjustment	(252)	1
Ending balance	<u>₩ 675,391</u>	<u>615,235</u>

(*) Comprise land and buildings, etc.

(c) Income and expenses on investment property for the years ended December 31, 2021 and 2020 are as follows:

	<u>December 31, 2021</u>	<u>December 31, 2020</u>
Rental income	₩ 35,887	23,890
Direct operating expenses for investment properties that generated rental income	12,033	11,951

(d) The fair value of investment property as of December 31, 2021 and 2020 is as follows:

	<u>December 31, 2021</u>	<u>December 31, 2020</u>
Land and buildings(*)	₩ 1,374,389	1,254,149

(*) Fair value of investment properties is estimated based in the recent market transaction conditions with an independent third party and certain significant unobservable inputs. Accordingly, fair value of investment properties is classified as level 3.

SHINHAN FINANCIAL GROUP CO., LTD. AND SUBSIDIARIES

Notes to the Consolidated Financial Statements

December 31, 2021 and 2020

(In millions of won)

17. Other assets

(a) Other assets as of December 31, 2021 and 2020 are as follows:

	<u>December 31, 2021</u>	<u>December 31, 2020</u>
Accounts receivable	₩ 12,754,436	12,511,880
Domestic exchange settlement debit	6,700,373	4,055,744
Guarantee deposits	1,077,644	1,145,045
Accrued income	2,655,894	2,535,847
Prepaid expense	491,950	202,218
Provisional payments	295,149	183,935
Sundry assets	88,797	106,341
Separate account assets	9,501,135	9,267,722
Advance payments	207,128	203,023
Unamortized deferred acquisition cost	954,949	979,942
Leased assets	1,395,334	1,016,013
Others	125,815	102,913
Discounted present value	(30,614)	(33,062)
Allowances for credit loss of other assets	(244,236)	(82,895)
	<u>₩ 35,973,754</u>	<u>32,194,666</u>

(b) Changes in unamortized deferred acquisition cost by insurance type for the year ended December 31, 2021 and 2020 are as follows:

		<u>December 31, 2021</u>					
		<u>Beginning balance</u>	<u>Acquisition cost incurred</u>			<u>Amortization</u>	<u>Ending balance</u>
			<u>Cost</u>	<u>Expensed</u>	<u>Deferral</u>		
Individual insurance							
Pure endowment insurance	₩	37,504	12,386	(3,680)	8,706	(23,468)	22,742
Death insurance		932,922	655,210	(278,147)	377,063	(393,942)	916,043
Endowment insurance		8,925	19,703	(8,382)	11,321	(4,477)	15,769
		<u>979,351</u>	<u>687,299</u>	<u>(290,209)</u>	<u>397,090</u>	<u>(421,887)</u>	<u>954,554</u>
Group insurance							
Pure protection		591	170	(64)	106	(302)	395
	₩	<u>979,942</u>	<u>687,469</u>	<u>(290,273)</u>	<u>397,196</u>	<u>(422,189)</u>	<u>954,949</u>
		<u>December 31, 2020</u>					
		<u>Beginning balance</u>	<u>Acquisition cost incurred</u>			<u>Amortization</u>	<u>Ending balance</u>
			<u>Cost</u>	<u>Expensed</u>	<u>Deferral</u>		
Individual insurance							
Pure endowment insurance	₩	67,856	11,602	(6,450)	5,152	(35,504)	37,504
Death insurance		834,415	771,973	(298,355)	473,618	(375,111)	932,922
Endowment insurance		4,764	19,024	(11,001)	8,023	(3,862)	8,925
		<u>907,035</u>	<u>802,599</u>	<u>(315,806)</u>	<u>486,793</u>	<u>(414,477)</u>	<u>979,351</u>
Group insurance							
Pure protection		833	343	(164)	179	(421)	591
	₩	<u>907,868</u>	<u>802,942</u>	<u>(315,970)</u>	<u>486,972</u>	<u>(414,898)</u>	<u>979,942</u>

SHINHAN FINANCIAL GROUP CO., LTD. AND SUBSIDIARIES

Notes to the Consolidated Financial Statements

December 31, 2021 and 2020

(In millions of won)

18. Leases

(a) Gross investment and present value of minimum lease payment of finance lease as of December 31, 2021 and 2020, are as follows:

		December 31, 2021		
		Gross investment	Unrealized interest income	Present value of minimum lease payment
Not later than 1 year	₩	635,826	65,349	570,477
1 ~ 2 years		470,800	39,631	431,169
2 ~ 3 years		308,999	18,738	290,261
3 ~ 4 years		191,257	6,606	184,651
4 ~ 5 years		113,638	4,417	109,221
Later than 5 years		5,170	32	5,138
	₩	<u>1,725,690</u>	<u>134,773</u>	<u>1,590,917</u>

(*) Interest income on finance lease receivables recognized for the year ended December 31, 2021 is ₩60,475 million.

		December 31, 2020		
		Gross investment	Unrealized interest income	Present value of minimum lease payment
Not later than 1 year	₩	678,790	73,230	605,560
1 ~ 2 years		527,757	43,701	484,056
2 ~ 3 years		391,447	21,169	370,278
3 ~ 4 years		219,040	6,089	212,951
4 ~ 5 years		93,975	432	93,543
Later than 5 years		6,320	53	6,267
	₩	<u>1,917,329</u>	<u>144,674</u>	<u>1,772,655</u>

(*) Interest income on finance lease receivables recognized for the year ended December 31, 2020 is ₩76,742 million.

SHINHAN FINANCIAL GROUP CO., LTD. AND SUBSIDIARIES

Notes to the Consolidated Financial Statements

December 31, 2021 and 2020

(In millions of won)

18. **Leases (continued)**

(b) Minimum lease payment receivable schedule for lease contracts of the Group as lessor as of December 31, 2021 and 2020 are as follows:

i) *Finance lease*

		December 31, 2021		
		Minimum lease payment	Present value adjustment	Present value of minimum lease payment
Not later than 1 year	₩	635,826	65,349	570,477
1 ~ 2 years		470,800	39,631	431,169
2 ~ 3 years		308,999	18,738	290,261
3 ~ 4 years		191,257	6,606	184,651
4 ~ 5 years		113,638	4,417	109,221
Later than 5 years		5,170	32	5,138
	₩	<u>1,725,690</u>	<u>134,773</u>	<u>1,590,917</u>
		December 31, 2020		
		Minimum lease payment	Present value adjustment	Present value of minimum lease payment
Not later than 1 year	₩	678,790	73,230	605,560
1 ~ 2 years		527,757	43,701	484,056
2 ~ 3 years		391,447	21,169	370,278
3 ~ 4 years		219,040	6,089	212,951
4 ~ 5 years		93,975	432	93,543
Later than 5 years		6,320	53	6,267
	₩	<u>1,917,329</u>	<u>144,674</u>	<u>1,772,655</u>

ii) *Operating lease*

		Minimum lease payment	
		December 31, 2021	December 31, 2020
Not later than 1 year	₩	371,521	276,590
1 ~ 2 years		320,603	233,443
2 ~ 3 years		251,720	182,261
3 ~ 4 years		147,134	124,556
4 ~ 5 years		53,879	52,997
Later than 5 years		94,143	95,414
	₩	<u>1,239,000</u>	<u>965,261</u>

SHINHAN FINANCIAL GROUP CO., LTD. AND SUBSIDIARIES

Notes to the Consolidated Financial Statements

December 31, 2021 and 2020

(In millions of won)

18. Leases (continued)

(c) Changes in operating lease assets for the years ended December 31, 2021 and 2020 are as follows:

		December 31, 2021	December 31, 2020
Beginning balance	₩	1,014,300	549,741
Acquisition		691,192	681,607
Disposal		(54,721)	(54,042)
Depreciation		(257,033)	(163,006)
Ending balance	₩	1,393,738	1,014,300

(d) The details of the right-of-use assets by the lessee's underlying asset type as of December 31, 2021 and 2020 are as follows:

		December 31, 2021		
		Acquisition cost	Accumulated depreciation	Carrying value
Real estate	₩	1,153,021	(578,980)	574,041
Vehicle		45,670	(23,821)	21,849
Others		30,478	(18,241)	12,237
	₩	1,229,169	(621,042)	608,127

		December 31, 2020		
		Acquisition cost	Accumulated depreciation	Carrying value
Real estate	₩	953,135	(396,716)	556,419
Vehicle		36,680	(16,059)	20,621
Others		26,368	(12,991)	13,377
	₩	1,016,183	(425,766)	590,417

(e) The details of the changes in the right-of-use assets for the years ended December 31, 2021 and 2020 are as follows:

		December 31, 2021			
		Real estate	Vehicle	Others	Total
Beginning balance	₩	556,419	20,621	13,377	590,417
Acquisition		295,228	17,524	4,173	316,925
Disposal		(22,829)	(4,070)	(31)	(26,930)
Depreciation(*)		(271,895)	(12,408)	(5,282)	(289,585)
Effects of foreign currency movements		17,118	182	-	17,300
Ending balance	₩	574,041	21,849	12,237	608,127

		December 31, 2020			
		Real estate	Vehicle	Others	Total
Beginning balance	₩	1,077,803	21,994	12,999	1,112,796
Acquisition		286,981	12,556	6,421	305,958
Disposal		(21,763)	(2,394)	(16)	(24,173)
Depreciation(*)		(268,376)	(11,625)	(6,027)	(286,028)
Substitution		(513,437)	-	-	(513,437)
Effects of foreign currency movements		(5,375)	(5)	-	(5,380)
Business combination (Note 47)		586	95	-	681
Ending balance	₩	556,419	20,621	13,377	590,417

(*) Included in general administrative expense and other operating income(expense) of the consolidated statements of comprehensive income.

SHINHAN FINANCIAL GROUP CO., LTD. AND SUBSIDIARIES

Notes to the Consolidated Financial Statements

December 31, 2021 and 2020

(In millions of won)

18. Leases (continued)

(f) The details of the maturity of the lease liability as of December 31, 2021 and 2020 are as follows:

		December 31, 2021						
		1 month or less	1 month ~ 3 months or less	3 months ~ 6 months or less	6 months ~ 1 year or less	1 year ~ 5 years or less	More than 5 years	Total
Real estate	₩	22,890	33,950	46,532	82,467	266,299	121,360	573,498
Vehicle		4,496	1,935	2,536	4,718	12,298	513	26,496
Others		465	650	1,124	2,205	8,226	26	12,696
	₩	<u>27,851</u>	<u>36,535</u>	<u>50,192</u>	<u>89,390</u>	<u>286,823</u>	<u>121,899</u>	<u>612,690</u>

		December 31, 2020						
		1 month or less	1 month ~ 3 months or less	3 months ~ 6 months or less	6 months ~ 1 year or less	1 year ~ 5 years or less	More than 5 years	Total
Real estate	₩	22,560	36,746	49,746	90,057	287,932	69,083	556,124
Vehicle		3,404	1,840	2,490	4,765	11,632	-	24,131
Others		520	806	1,203	2,031	9,345	1	13,906
	₩	<u>26,484</u>	<u>39,392</u>	<u>53,439</u>	<u>96,853</u>	<u>308,909</u>	<u>69,084</u>	<u>594,161</u>

(*) The above amounts are based on undiscounted cash flows, and have been classified at the earliest maturity that the Group has the obligation to pay.

(g) The lease payments for low-value assets and short-term leases for the years ended December 31, 2021 and 2020 are as follows:

	December 31, 2021	December 31, 2020
Low-value assets	₩ 5,885	6,181
Short-term lease (*)	766	836
Total	₩ <u>6,651</u>	<u>7,017</u>

(*) The payments for leases with terms less than 1 month are included.

SHINHAN FINANCIAL GROUP CO., LTD. AND SUBSIDIARIES

Notes to the Consolidated Financial Statements

December 31, 2021 and 2020

(In millions of won)

19. Pledged assets

(a) Assets pledged as collateral as of December 31, 2021 and 2020 are as follows:

	<u>December 31, 2021</u>	<u>December 31, 2020</u>	<u>Reasons for collateral</u>
Securities:			
Securities at FVTPL	₩ 14,944,525	15,328,573	Customer RP, etc
Securities at FVOCI	3,244,232	4,058,033	Borrowings, Settlement security for Bank of Korea, Borrowing securities, etc
Securities at amortized cost	16,284,795	14,516,567	Borrowings, Settlement security for Bank of Korea, Customer RP, etc
	<u>34,473,552</u>	<u>33,903,173</u>	
Deposits at amortized cost	958,206	784,626	Borrowings, etc
Property and Equipment (real estate)	300,352	301,098	Establishing the right to collateral security, etc
Other financial assets	-	355	Performance guarantee, etc
	<u>₩ 35,732,110</u>	<u>34,989,252</u>	

(*) The carrying values of assets pledged that the pledgees have the right to sell or re-pledge regardless of the Group's default as of December 31, 2021 and 2020 are ₩11,017,362 million and ₩11,190,218 million, respectively.

(b) The fair value of collateral held that the Group has the right to sell or re-pledge regardless of the pledger's default as of December 31, 2021 and 2020 are as follows:

	<u>December 31, 2021</u>		<u>December 31, 2020</u>	
	<u>Assets received as collateral</u>	<u>The fair value of collateral sold or re-provided as collateral</u>	<u>Assets received as collateral</u>	<u>The fair value of collateral sold or re-provided as collateral</u>
Securities	₩ 2,163,744	-	2,871,910	-

SHINHAN FINANCIAL GROUP CO., LTD. AND SUBSIDIARIES

Notes to the Consolidated Financial Statements

December 31, 2021 and 2020

(In millions of won)

20. Deposits

Deposits as of December 31, 2021 and 2020 are as follows:

	<u>December 31, 2021</u>	<u>December 31, 2020</u>
Demand deposits:		
Korean won	₩ 151,787,483	132,444,929
Foreign currencies	20,320,241	16,280,268
	<u>172,107,724</u>	<u>148,725,197</u>
Time deposits:		
Korean won	140,651,250	137,719,464
Foreign currencies	20,847,651	20,114,427
	<u>161,498,901</u>	<u>157,833,891</u>
Certificates of deposits	16,576,536	5,946,704
Discount note deposits	5,818,001	6,226,937
CMA	5,246,478	4,006,319
Others	3,649,035	3,677,820
	<u>₩ 364,896,675</u>	<u>326,416,868</u>

SHINHAN FINANCIAL GROUP CO., LTD. AND SUBSIDIARIES

Notes to the Consolidated Financial Statements

December 31, 2021 and 2020

(In millions of won)

21. Financial liabilities at fair value through profit or loss

Financial liabilities at fair value through profit or loss as of December 31, 2021 and 2020 are as follows:

	<u>December 31, 2021</u>	<u>December 31, 2020</u>
Securities sold:		
Stocks	₩ 275,451	387,857
Bonds	505,202	503,920
Others	7,114	5,352
	<u>787,767</u>	<u>897,129</u>
Gold/silver deposits	581,458	539,565
	₩ <u>1,369,225</u>	<u>1,436,694</u>

22. Financial liabilities designated at fair value through profit or loss

(a) Financial liabilities designated at fair value through profit or loss as of December 31, 2021 and 2020 are as follows:

	<u>December 31, 2021</u>	<u>December 31, 2020</u>	<u>Reason for designation</u>
Equity-linked securities sold	₩ 5,795,071	6,556,288	Compound financial instrument
Securities sold with embedded derivatives	2,228,799	1,899,436	
	₩ <u>8,023,870</u>	<u>8,455,724</u>	

(*) The Group designated the financial liabilities at the initial recognition(or subsequently) in accordance with paragraph 6.7.1 of K-IFRS No. 1109 as financial liabilities at fair value through profit or loss.

Maximum credit risk exposure of the financial liabilities designated at fair value through profit or loss amounts to ₩8,023,870 million as of December 31, 2021. Decrease in values of the liability due to credit risk changes is ₩1,526 million for the year ended December 31, 2021 and the accumulated changes in values are ₩(-)2,506 million as of December 31, 2021.

(b) The difference between the carrying value of financial liabilities designated at fair value through profit or loss and the amount required to be paid at contractual maturity as of December 31, 2021 and 2020 are as follows:

	<u>December 31, 2021</u>	<u>December 31, 2020</u>
Expiration payment	₩ 7,325,678	7,568,498
Carrying value	<u>8,023,870</u>	<u>8,455,724</u>
Difference from carrying value	₩ <u>(698,192)</u>	<u>(887,226)</u>

SHINHAN FINANCIAL GROUP CO., LTD. AND SUBSIDIARIES

Notes to the Consolidated Financial Statements

December 31, 2021 and 2020

(In millions of won)

23. Borrowings

Borrowings as of December 31, 2021 and 2020 are as follows:

	December 31, 2021		December 31, 2020	
	Interest rate (%)	Amount	Interest rate (%)	Amount
Borrowings denominated in Korean won:				
Borrowings from Bank of Korea	0.25~0.25	₩ 5,278,331	0.25~0.25	₩ 5,351,110
Others	0.00~3.93	18,412,343	0.00~6.20	16,375,272
		<u>23,690,674</u>		<u>21,726,382</u>
Borrowings denominated in foreign currencies:				
Overdraft due from banks	0.00~0.30	42,434	0.00	71,309
Borrowings from banks	(0.49)~12.29	5,292,872	0.00~8.00	5,423,571
Others	0.00~11.25	1,890,291	0.00~12.45	1,538,021
		<u>7,225,597</u>		<u>7,032,901</u>
Call money	(0.30)~ 1.52	1,534,611	0.35~ 0.55	1,760,042
Bill of sale	0.00~ 1.47	9,032	0.00~ 1.10	10,706
Bonds sold under repurchase agreements:	0.00~ 6.25	10,709,115	0.00~ 5.15	11,065,584
Deferred origination costs		(1,964)		(1,551)
		<u>₩ 43,167,065</u>		<u>₩ 41,594,064</u>

SHINHAN FINANCIAL GROUP CO., LTD. AND SUBSIDIARIES

Notes to the Consolidated Financial Statements

December 31, 2021 and 2020

(In millions of won)

24. Debt securities issued

Debt securities issued as of December 31, 2021 and 2020 are as follows:

	December 31, 2021		December 31, 2020	
	Interest rate (%)	Amount	Interest rate (%)	Amount
Debt securities issued in Korean won:				
Debt securities issued	0.79~8.00	₩ 64,419,771	0.67~8.00	₩ 59,816,756
Subordinated debt securities issued	2.20~4.60	5,030,125	2.20~4.60	4,370,125
Gain on fair value hedges	-	(122,069)	-	(63,652)
Discount on debt securities issued	-	(38,845)	-	(39,309)
		<u>69,288,982</u>		<u>64,083,920</u>
Debt securities issued in foreign currencies:				
Debt securities issued	0.25~7.59	7,462,087	0.25~7.59	7,182,619
Subordinated debt securities issued	3.34~5.10	3,307,306	3.34~5.10	3,598,624
Loss on fair value hedges	-	130,392	-	309,880
Discount on debt securities issued	-	(39,404)	-	(40,649)
		<u>10,860,381</u>		<u>11,050,474</u>
		<u>₩ 80,149,363</u>		<u>₩ 75,134,394</u>

25. Defined benefit plans

(a) Defined benefit plan assets and obligations

The Group has operated a defined benefit plan and calculates defined benefit obligations based on the employee's pension compensation benefits and service period.

Defined benefit obligations and plan assets as of December 31, 2021 and 2020 are as follows:

	December 31, 2021	December 31, 2020
Present value of defined benefit obligations	₩ 2,205,869	2,182,464
Fair value of plan assets	(2,296,685)	(2,138,324)
Recognized liability(asset) for defined benefit obligations(*)	<u>₩ (90,816)</u>	<u>44,140</u>

(*) The asset for defined benefit obligation of ₩90,816 million as of December 31, 2021 is the net defined benefit assets of ₩142,020 million less the net defined liabilities of ₩51,204 million. In addition, the liability for defined benefit obligation of ₩44,140 million as of December 31, 2020 is the net defined benefit liabilities of ₩62,514 million less the net defined assets of ₩18,374 million.

SHINHAN FINANCIAL GROUP CO., LTD. AND SUBSIDIARIES

Notes to the Consolidated Financial Statements

December 31, 2021 and 2020

(In millions of won)

25. Defined benefit plans (continued)

(b) Changes in the present value of defined benefit obligation and plan assets for the years ended December 31, 2021 and 2020 are as follows:

	December 31, 2021		
	Defined benefit obligation	Plan assets	Net defined benefit liability(asset)
Beginning balance	₩ 2,182,464	(2,138,324)	44,140
Included in profit or loss:			
Current service cost	179,751	-	179,751
Past service cost	2,570	-	2,570
Interest expense (income)	64,729	(64,759)	(30)
Settlement income	(4,844)	-	(4,844)
	<u>242,206</u>	<u>(64,759)</u>	<u>177,447</u>
Included in other comprehensive income:			
Remeasurement loss (gain):			
- Actuarial gains (losses) arising from :			
Demographic assumptions	(1,642)	-	(1,642)
Financial assumptions	(87,406)	2,421	(84,985)
Experience adjustment	(5,450)	-	(5,450)
- Return on plan assets excluding interest income	-	32,720	32,720
	<u>(94,498)</u>	<u>35,141</u>	<u>(59,357)</u>
Other:			
Benefits paid by the plan	(127,493)	120,347	(7,146)
Succession through related party transactions	5,135	-	5,135
Contributions paid into the plan	(10)	(249,099)	(249,109)
Settlement gain or loss	(2,231)	9	(2,222)
Effect of changes in foreign exchange rates	296	-	296
	<u>(124,303)</u>	<u>(128,743)</u>	<u>(253,046)</u>
Ending balance	₩ <u>2,205,869</u>	<u>(2,296,685)</u>	<u>(90,816)</u>

(*) Profit and loss related to defined benefit plans are all included in the general administrative expense.

SHINHAN FINANCIAL GROUP CO., LTD. AND SUBSIDIARIES

Notes to the Consolidated Financial Statements

December 31, 2021 and 2020

(In millions of won)

25. Defined benefit plans (continued)

(b) Changes in the present value of defined benefit obligation and plan assets for the years ended December 31, 2021 and 2020 are as follows (continued):

	December 31, 2020		
	Defined benefit obligation	Plan assets	Net defined benefit liability(asset)
Beginning balance	₩ 2,063,102	(1,943,644)	119,458
Included in profit or loss:			
Current service cost	179,390	-	179,390
Past service cost	9,069	-	9,069
Interest expense (income)	57,674	(55,466)	2,208
Settlement expense	(306)	-	(306)
	<u>245,827</u>	<u>(55,466)</u>	<u>190,361</u>
Included in other comprehensive income:			
Remeasurement loss (gain):			
- Actuarial gains (losses) arising from :			
Demographic assumptions	18	-	18
Financial assumptions	(44,424)	-	(44,424)
Experience adjustment	2,957	-	2,957
- Return on plan assets excluding interest income	-	20,027	20,027
	<u>(41,449)</u>	<u>20,027</u>	<u>(21,422)</u>
Other:			
Benefits paid by the plan	(83,614)	77,567	(6,047)
Contributions paid into the plan	(268)	(239,570)	(239,838)
Settlement gain or loss	(2,695)	4,053	1,358
Business combination (Note 47)	2,139	(1,291)	848
Effect of changes in foreign exchange rates	(578)	-	(578)
	<u>(85,016)</u>	<u>(159,241)</u>	<u>(244,257)</u>
Ending balance	₩ <u>2,182,464</u>	<u>(2,138,324)</u>	<u>44,140</u>

(*) Profit and loss related to defined benefit plans are all included in the general administrative expense.

SHINHAN FINANCIAL GROUP CO., LTD. AND SUBSIDIARIES

Notes to the Consolidated Financial Statements

December 31, 2021 and 2020

(In millions of won)

25. Defined benefit plans (continued)

(c) The composition of plan assets as of December 31, 2021 and 2020 are as follows:

	<u>December 31, 2021</u>	<u>December 31, 2020</u>
Plan assets comprise:		
Equity securities	₩ -	74,631
Debt securities	43,607	23,713
Due from banks	1,915,361	1,900,963
Others	337,717	139,017
	<u>₩ 2,296,685</u>	<u>2,138,324</u>

(d) Actuarial assumptions as of December 31, 2021 and 2020 are as follows:

	<u>December 31, 2021</u>	<u>December 31, 2020</u>	<u>Description</u>
Discount rate	3.19%~3.77%	2.68%~3.30%	AA0 corporate bond yields
Future salary increase rate	1.98%~5.00%	1.90%~4.00%	Average for 5 years
	+ Upgrade rate	+ Upgrade rate	
Weighted average maturity	7.4 years~ 14.8 years	7.6 years~ 15.4 years	

(e) Sensitivity analysis

As of December 31, 2021 and 2020, reasonably possible changes in one of the relevant actuarial assumptions, holding other assumptions constant, would have affected the defined benefit obligation by the amounts shown below.

	<u>December 31, 2021</u>	
	<u>Defined benefit obligation</u>	
	<u>Increase</u>	<u>Decrease</u>
Discount rate (1%p movement)	₩ (197,174)	216,226
Future salary increase rate (1%p movement)	216,450	(200,843)
	<u>December 31, 2020</u>	
	<u>Defined benefit obligation</u>	
	<u>Increase</u>	<u>Decrease</u>
Discount rate (1%p movement)	₩ (207,093)	233,570
Future salary increase rate (1%p movement)	232,892	(210,305)

(f) The Group's estimated contribution is ₩ 182,632 million as of December 31, 2022.

26. Provisions

(a) Provisions as of December 31, 2021 and 2020 are as follows:

	<u>December 31, 2021</u>	<u>December 31, 2020</u>
Asset retirement obligations	₩ 82,123	65,659
Expected loss related to litigation	9,693	12,468
Unused credit commitments	300,008	305,719
Guarantee contracts issued	81,922	83,851
Financial guarantee contracts issued	55,344	61,895
Non-financial guarantee contracts issued	26,578	21,956
Others(*)	693,110	337,039
	<u>₩ 1,166,856</u>	<u>804,736</u>

(*) As of December 31, 2021 and 2020, the Group recognizes a provision of ₩518,955 million and ₩211,365 million, respectively, an estimated amount which is highly probable to be paid for customer losses expected due to delays in redemption of Lime CI funds.

SHINHAN FINANCIAL GROUP CO., LTD. AND SUBSIDIARIES

Notes to the Consolidated Financial Statements

December 31, 2021 and 2020

(In millions of won)

26. Provisions (continued)

(b) Changes in provision for unused credit commitments and financial guarantee contracts issued for the years ended December 31, 2021 and 2020 are as follows:

	December 31, 2021						Total
	Unused credit commitments			Financial guarantee contracts issued			
	12 months expected credit loss	Life time expected credit loss	Impaired financial asset	12 months expected credit loss	Life time expected credit loss	Impaired financial asset	
Beginning allowance	₩ 164,147	140,137	1,435	54,550	7,335	10	367,614
Transfer (from)to 12 months expected credit loss	63,335	(63,249)	(86)	2,931	(2,931)	-	-
Transfer (from)to life time expected credit loss	(11,889)	11,917	(28)	(3,621)	3,621	-	-
Transfer (from)to impaired financial asset	(274)	(939)	1,213	-	-	-	-
Provided (reversed)	(66,373)	58,188	(610)	(581)	(178)	5	(9,549)
Change in foreign exchange rate	1,964	1,077	-	1,910	534	-	5,485
Others(*)	(337)	380	-	(6,582)	(1,672)	13	(8,198)
Ending balance	₩ <u>150,573</u>	<u>147,511</u>	<u>1,924</u>	<u>48,607</u>	<u>6,709</u>	<u>28</u>	<u>355,352</u>

(*) Others include effects of the provision from the new financial guarantee contracts measured at fair value, and the expired contracts, and the change of discount rate.

SHINHAN FINANCIAL GROUP CO., LTD. AND SUBSIDIARIES

Notes to the Consolidated Financial Statements

December 31, 2021 and 2020

(In millions of won)

26. Provisions (continued)

(b) Changes in provision for unused credit commitments and financial guarantee contracts issued for the years ended December 31, 2021 and 2020 are as follows (continued):

	December 31, 2020						Total
	Unused credit commitments			Financial guarantee contracts issued			
	12 months expected credit loss	Life time expected credit loss	Impaired financial asset	12 months expected credit loss	Life time expected credit loss	Impaired financial asset	
Beginning allowance	₩ 132,028	119,839	11,885	68,467	5,569	811	338,599
Transfer (from)to 12 months expected credit loss	63,818	(55,295)	(8,523)	2,059	(2,059)	-	-
Transfer (from)to life time expected credit loss	(9,883)	11,365	(1,482)	(3,951)	3,951	-	-
Transfer (from)to impaired financial asset	(244)	(875)	1,119	-	-	-	-
Provided (reversed)	(20,377)	65,455	(1,564)	8,258	1,845	(822)	52,795
Change in foreign exchange rate	(1,195)	(352)	-	(1,335)	(223)	(49)	(3,154)
Others (*)	-	-	-	(18,948)	(1,748)	70	(20,626)
Ending balance	₩ 164,147	140,137	1,435	54,550	7,335	10	367,614

(*) Others include effects of the provision from the new financial guarantee contracts measured at fair value, and the expired contracts, and the change of discount rate.

SHINHAN FINANCIAL GROUP CO., LTD. AND SUBSIDIARIES

Notes to the Consolidated Financial Statements

December 31, 2021 and 2020

(In millions of won)

26. Provisions (continued)

(c) Changes in provisions for the years ended December 31, 2021 and 2020 are as follows:

December 31, 2021					
	Asset retirement	Litigation	Guarantee	Others	Total
Beginning balance	₩ 65,659	12,468	21,956	337,039	437,122
Provision(reversal)	8,185	2,552	3,457	350,090	364,284
Provision used	(3,793)	(5,327)	-	(37,604)	(46,724)
Change in foreign exchange rate	4	-	1,265	(1,314)	(45)
Others(*)	12,068	-	(100)	44,899	56,867
Ending balance	₩ 82,123	9,693	26,578	693,110	811,504

(*) Others include increase in provisions based on the present value and the effect of changes in discount rate over the period.

December 31, 2020					
	Asset retirement	Litigation	Guarantee	Other	Total
Beginning balance	₩ 64,922	8,789	25,583	119,131	218,425
Provision(reversal)	898	4,317	(2,709)	261,983	264,489
Provision used	(2,463)	(638)	-	(46,654)	(49,755)
Change in foreign exchange rate	(3)	-	(1,030)	570	(463)
Others(*)	2,305	-	112	1,814	4,231
Business combination (Note 47)	-	-	-	195	195
Ending balance	₩ 65,659	12,468	21,956	337,039	437,122

(*) Others include increase in provisions based on the present value and the effect of changes in discount rate over the period.

(d) Asset retirement obligation liabilities represent the estimated cost to restore the existing leased properties which is discounted to the present value using the appropriate discount rate at the end of the reporting period. Disbursements of such costs are expected to incur at the end of lease contract. Such costs are reasonably estimated using the average lease year and the average restoration expenses. The average lease year is calculated based on the past ten-year historical data of the expired leases. The average restoration expense is calculated based on the actual costs incurred for the past three years using the three-year average inflation rate.

(e) Allowance for guarantees and acceptances as of December 31, 2021 and 2020 are as follows:

	December 31, 2021	December 31, 2020
Outstanding guarantees and acceptances	₩ 10,540,968	10,249,827
Contingent guarantees and acceptances	4,670,771	3,433,953
ABS and ABCP purchase commitments	1,525,768	1,604,958
Endorsed bill	8,199	1,650
	₩ 16,745,706	15,290,388
Allowance for loss on guarantees and acceptances	₩ 81,922	83,851
Ratio	%	0.49
		0.55

SHINHAN FINANCIAL GROUP CO., LTD. AND SUBSIDIARIES

Notes to the Consolidated Financial Statements

December 31, 2021 and 2020

(In millions of won)

27. Liability under insurance contracts

(a) Overview of the insurance risk

i) Insurance risk and reinsurance

Insurance risk is the possibility of insured events to occur, and it refers to an uncertainty of the amount and the timing of claims that incurred as an occurrence of the insured event. The main risks faced by insurance contracts include the risk of actual claims or benefits exceeding insurance liability. These risks may arise due to following reasons:

① Frequency risk

The risk of actual number of claims being different from the number of claims anticipated by the insurer.

② Depth risk

The risk of an actual amount of claims being different from the expected amount of claims anticipated by the insurer.

As there are more numbers of insurance contracts that are empirically similar or are diversified, it is less likely to have abnormal effects from some of the contracts. The Group is trying to form a sufficiently diversified group of contracts considering these points when acquiring a contract. Insurance risk includes a lack of risk diversification and is related to geographical area, the characteristics of policyholders as well as diversification of the form or the size of the risk.

If the insurance covers death, the frequency, or the death rates are mostly affected by natural causes, while other causes may include eating habits, smoking and exercise habits etc. If the insurance provides lifetime coverage, the survival rates may rise due to developments of medical technology or enhancements in social conditions. Insured events of life insurance include not only death of the policyholder (the insured person), but also survival, disability and hospitalization.

The Group basically divides the entity's insurance products into individual and group insurance depending on the characteristics of the policyholder. Group insurance refers to a contract in which the insured person belongs to an organization of a certain or a larger size, and he/she is the representative of that organization. Group insurance can largely be divided into pure protection and savings insurance. Pure protection insurance refers to insurance in which the amount of claim paid for survival does not exceed the premiums paid, and savings insurance is defined as insurance in which the amount of claim paid for survival exceeds the premium paid. Individual insurance can largely be divided into death insurance which considers death of a policyholder as an insured event, pure endowment insurance which considers a survival of a certain period of time as an insured event, and endowment insurance which is a combination of pure endowment and death insurance.

Life insurance products can also be divided into fixed rate insurance which guarantees fixed interest rates, a floating rate insurance which is accreted at variable interest rates, and a dividend-paying insurance based on interest rate application scheme.

For fixed rate products, interest rates expected at the beginning of the insurance contract do not vary till the end of the contract. Hence, if the return on assets or market rates are lower than the expected rates, the entity will bear the interest rate risk. On the other hand, for floating rate products, net premium is divided into guarantees and reserves portion. For guarantees portion, fixed interest rate is applied while for reserves portion, floating interest rates are applied to the reserves based on return on assets. As a result, though hedging may be possible for some interest rate risks, as the minimum guaranteed rate is fixed for reserves, interest rate risks will be borne in accordance with the changes in return on assets.

To manage the uncertainty of the amount and timing of the claims arising due to occurrences of insured events, that is, an insurance risk, the Group uses an acquisition and a reinsurance strategy.

SHINHAN FINANCIAL GROUP CO., LTD. AND SUBSIDIARIES

Notes to the Consolidated Financial Statements

December 31, 2021 and 2020

(In millions of won)

27. Liability under insurance contracts (continued)

(a) Overview of the insurance risk (continued)

① Acquisition strategy

Acquisition strategy is a strategy to diversify the types of risks or the level of claims. For example, an entity can manage each mortality risk and survival risk in a balanced manner. In addition, the policyholder's choice of a regular check-up is one of the main acquisition strategies.

② Reinsurance strategy

The Group's reinsurer risk is based on the insurance contracts acquired and may be the amount of risks per contract or the total amount of risks based on number of contracts or insured person. In principle, reinsurance is applied in excess of risk insurance premiums, but other methods can be used to the extent recognized by relevant laws and regulations, where necessary. The limit of holding reinsurance is determined by considering the assets, types of contracts, risk level, contract selecting technology of the Group.

Insurance risk can also be affected by the policyholder's right to reduce premiums or not paying in premiums in full by terminating the contract or exercising a conversion of pension rights. As a result, insurance risk is likely to be affected by the actions and decisions of the policyholders. The insurance risk of the Group may be estimated under the assumption that the policyholder makes reasonable decisions. For instance, people with bad health will have lower intentions to terminate the contract which provides insurance over death, rather than those with good health. These factors are also reflected in the assumptions of evaluating the insurance liability of the Group.

ii) Discretionary participation features

The discretionary participation feature is a contractual right to receive additional benefits with the following characteristics in addition to the benefits that policyholders or investors have unconditional rights and meets all the three criteria below. The premiums for investment contracts without discretionary participation features are recognized as deposits, and premiums for investment contracts with discretionary participation features are recognized as profits or losses, like insurance contracts.

- ① they are expected to be a significant portion of the total contractual benefits;
- ② the timing or amount of which are contractually at the discretion of the issuer; and
- ③ they are contractually based on:
 - i) the returns on a specified pool of contracts or a specified type of contract; or
 - ii) realised and/or unrealised investment returns on a specified pool of assets held by the issuer; or
 - iii) the profit or loss of the entity or fund that issues the contract.

The investment contracts held by the Group meets all the above criteria, hence they do include discretionary participation features.

If the expected base rate of interest and the actual base rate of interest match, income and expenses are balanced through insurance contracts, so that premiums are not excessively insufficient. However, when calculating premiums, the expected mortality rate, interest rate, and operating expense ratios change due to changes in risk rates or economic conditions, which will result to differences with the actual premiums. These differences constitute the profits and losses of the Group and will consist of profit or loss from the differences in risk rate, interest rate and operating expense depending on the source of occurrence.

In case of contracts with discretionary participation features, it reduces risk as participation features are shared among the policyholder and the Group for the below sources of profit or loss.

SHINHAN FINANCIAL GROUP CO., LTD. AND SUBSIDIARIES

Notes to the Consolidated Financial Statements

December 31, 2021 and 2020

(In millions of won)

27. Liability under insurance contracts (continued)

(a) Overview of the insurance risk (continued)

① Profit or loss due to differences in mortality rates

It occurs due to the difference between the expected and the actual mortality rate. For death insurance, if the actual mortality rate is lower than the expected mortality rate, profits occur, and for the opposite case, losses occur.

② Profit or loss due to differences in interest rates

It occurs due to the difference between the expected and the actual interest rate. If the actual operating return on assets is higher than the expected interest rate, profits occur, and for the opposite case, losses occur.

③ Profit or loss due to differences in operating expenses

It is caused by the difference between the expected and the actual operating expenses ratio. If the actual operating expenses are lower than the expected operating expenses, profits occur, and for the opposite case, losses occur.

As seen above, the source of the profits being generated when the expected base rate used by the Group in calculating the insurance premiums is different from the actual rate is within the premium which has been roughly calculated, hence the profits must be returned to the policyholder. This type of amount being distributed is called the policyholder dividend and is distinguished from the shareholder dividend.

At the end of each reporting period, the Group adds to existing policy reserve and divides the remaining amount into dividend or non-dividend insurance gains and losses, and capital gains and losses. Non-dividend insurance gains and losses and capital gains and losses are treated as shareholders' interest, shareholders' interest in dividend insurance profits are less than 10/100, and the remaining portion is treated as policyholder's interest. Policyholders' interest may not be used or accumulated for any purpose other than financial resources for policyholder dividends and the purpose of accumulating reserves for loss from participating insurance.

Policyholder dividends are divided into interest dividends, long-term duration dividends, mortality dividends, and expense dividends, and reserves for policyholder dividends are divided into reserve for participating policyholder's dividends and excess participating policyholder dividend reserve. Excess participating policyholder dividend reserve is the total amount accumulated to be used as future policyholder dividend funds if there is any surplus left after accumulating reserves for loss from participating insurance and reserves for participating policyholder's dividends from the policyholder's stake in the relevant business year.

Reserve for participating policyholder's dividends are fixed dividend reserves in which the amount to be allocated is confirmed for each policyholder, while excess participating policyholder dividend reserves are not a confirmed amount to be paid to the policyholders. The Group shall first use the total amount of excess participating policyholder dividend reserves accumulated prior to the current financial year as reserves for participating policyholder's dividends, and the accumulated excess participating policyholder dividend reserves shall be used as a resource of policyholder dividends within five years from the end of the current year.

Reserves for loss from participating insurance are accumulated for the purpose of compensating for losses in dividend insurance contracts under laws, etc., and shall take precedence over reserves for participating policyholder's dividends and excess participating policyholder dividend reserves.

Reserves for loss from participating insurance are accumulated within 30/100 of the policyholder's stake, and are compensated for losses incurred in dividend insurance contracts within five years of accumulation, and the remaining amount after preservation is used as a resource of policyholder dividends.

SHINHAN FINANCIAL GROUP CO., LTD. AND SUBSIDIARIES

Notes to the Consolidated Financial Statements

December 31, 2021 and 2020

(In millions of won)

27. Liability under insurance contracts (continued)

(b) Insurance risk management policy

Unlike other financial products, life insurance products have the nature of long-term duration, which can lead to a significant increase in actual claims in comparison to the risk rates set at product development stage, and the entities may be exposed to differences in interest rates and maturity of insurance liability and the financial asset.

The purpose of the Group's risk management is to reflect these uncertain financial environments and the characteristics of life insurance products with long-term duration to prevent and systematically manage various risks in the course of management activities.

In order to achieve this, risk management strategy of the Group is to measure the required capital of the Risk-Based Capital (RBC) and to manage it within an acceptable range. To achieve this, the Group has established and implemented basic principles for risk management and has established regulations and management systems aiming for the implementation to be successful. Also, the Risk Management Committee and the Risk Management TF are in place to support various risk-related decisions and prepare risk management procedures to identify and manage risks in a timely manner.

In general, risk management procedures are to recognize exposed risks, measure their scale, set acceptable limits, monitor them regularly and report them to management, and control them efficiently to prevent the case of risks exceeding the limits.

The risk management methods of different types of risks are as follows.

① Insurance risk management

From the product development stage, profitability guidelines are set to secure appropriate level of profitability, acquisition standards are set and operated to prevent reverse selection, and payment review standards are operated to ensure fairness upon payments of claims.

② Interest risk management

Determination of the official interest rate and the estimated interest rate within the scope of the guideline in consideration of the market interest rate and the rate of return on operating assets. In addition, asset management strategies are established in consideration of the interest rate and maturity structure of liabilities, long-term target portfolios are established and annually viable portfolios are set as guidelines to allocate and operate assets based on the risk level and return on assets after analyzing the long-term insurance liability.

③ Liquidity risk management

Inspection and management of insurance payments and current assets on a day-to-day basis.

SHINHAN FINANCIAL GROUP CO., LTD. AND SUBSIDIARIES

Notes to the Consolidated Financial Statements

December 31, 2021 and 2020

(In millions of won)

27. Liability under insurance contracts (continued)

(c) Statutory reserves

Policy reserves are liabilities related to policyholders, and the fidelity of accumulating reserves based on profit or loss is being strictly regulated by the regulators as they are directly related to maintaining the quality of the business and protecting the interests of policyholders. Accordingly, the supervisory authorities are reinforcing the statutory reserves system in relation to the method of accumulating and calculating each policy reserve.

The current method, which uses the basic reserve rates as equivalent to the basic rate of premium calculation, may threaten the financial quality of the Group by causing insolvency of reserves when insurance prices are liberally set. The system is designed to prevent insolvency of the financial structure that can lead to liberalization of premium and protect the rights and interests of policyholders by introducing a statutory reserves system to use objective and conservative basic rates when accumulating reserves.

In other words, statutory reserve is an institutional framework that dualizes the base rate of contracts by evaluating the fidelity of reserves by setting the risk rate or interest rate applied to calculate policy reserves more conservatively than the risk rate or interest rate applied when calculating the premiums. For an insurer to calculate its policy reserves, it needs expected base rates of the future such as interest base rates and expected risk rates, and the estimated valuation of the liability based on these expected base rates is the policy reserve. As simply leaving these policy reserves entirely to the insurance entity's self-determination after the liberalization of policy reserves framework is not the main purpose of the liberalization, the government needs to establish a certain level of reserve framework to protect policyholders, strengthen financial solvency of the insurance entities, and prevent insurance entities from being insolvent due to price competition such as insurance dumping.

According to the regulations on supervision of insurance business, premium reserves are calculated by applying the base rate of interest and base risk rate set by the Financial Supervisory Service. In this case, the base rate is the base rate of interest for the year of entering into an insurance contract over the entire coverage period. However, the highest interest rate among the accreted interest rate set in the premiums and policy reserves calculation method is applied for the reserves of interest-sensitive insurance. As a result, if the premium reserves calculated at the base rate applied in calculation of the premiums and the premium reserves calculated at the base rate of interest and base risk rates are different, a large amount should be set aside as the premium reserves to protect the policyholder by accumulating reserves above a certain level.

Current policy reserves are calculated by the year of issuance evaluation. In other words, the base rate of valuation of policy reserves are applied equally to the interest rate and risk rate applied at the time of entering an insurance contract until the end of the contract. This method is suitable for stable circumstances in which the financial environment at the sale of insurance products and the financial environment during the policy period barely change, so liability can be accumulated stably, but it cannot be dealt flexibly with in the event of changes in market interest rates and expected risk upon the sale of a contract. Therefore, there is a possibility that the policy reserves will not properly reflect the fair value of the contract. To compensate for the shortcomings that do not reflect these market changes, the Liability Adequacy Test was introduced.

SHINHAN FINANCIAL GROUP CO., LTD. AND SUBSIDIARIES

Notes to the Consolidated Financial Statements

December 31, 2021 and 2020

(In millions of won)

27. Liability under insurance contracts (continued)

(d) Financial risks related to insurance contracts

i) Forms of risk exposure and the different types of risks

Investment contracts with insurance contracts and discretionary participation features may be exposed to insurance liability or financial risks, and the form of exposure is as follows.

① Credit risk

Credit risk refers to the risk of loss caused by the counterparty's default in provision of funds or entering a contract agreed to exchange at a predetermined price at a certain point in the future. The Group's reinsurance assets and reinsurance receivables are exposed to losses in case of default by the reinsurer upon collection of premiums and receivables from the reinsurer in the future.

② Interest rate risk

Interest rate risk refers to the risk that occurs when the financial position of the Group is affected by the adverse interest rate movements on assets and liabilities.

③ Liquidity risk

Liquidity risk refers to a risk caused by inconsistency in the maturity of assets and liabilities or failure to respond to unexpected capital outflows. Therefore, future cash outflows from investment contracts with insurance liability and discretionary participation features which takes the most proportion of the Group's liabilities, will determine the level of risk related to the liquidity of the Group.

④ Market risk

Market risk refers to the risk of losses being incurred when the entity's financial position is affected by the adverse price movements such as stock prices and exchange rates. The prices of investment contracts with insurance liability and discretionary participation features, does not change due to movements in stock prices and exchange rates, hence there is no effect on profit or loss and capital from movements in the amount of each liability.

ii) The degree to which discretionary participation features mitigate or increase the risk.

For contracts with discretionary participation features, policyholders will receive relatively high premiums by calculating the expected base rate relatively conservative compared to contracts without discretionary participation features, and future payments of premiums will be refunded to the policyholders through policyholder dividends. However, for contracts without discretionary participation features, an optimal expected base rate which is unlikely to be conservative will be set when setting the initial expected base rate and policyholders will receive a relatively low premium. Furthermore, if the expected and the actual base rates are different, the Group will bear the resulting profit or loss. Therefore, a contract with discretionary participation features has a structure in which a conservative base rate of interest is set, and risks related to the contract are shared with the policyholder. In the case of a contract without discretionary participation features, the entity alone bears the risk of the initial base rate of interest.

iii) Risks associated with guarantees

Guarantee options inherent in insurance contracts include Guaranteed Minimum Death Benefit (GMDB), Guaranteed Minimum Pension (GMP), and guaranteed minimum interest rate, which can increase cash outflows where market prices and interest rates fall below a certain level.

SHINHAN FINANCIAL GROUP CO., LTD. AND SUBSIDIARIES

Notes to the Consolidated Financial Statements

December 31, 2021 and 2020

(In millions of won)

27. Liability under insurance contracts (continued)

(e) Insurance liabilities as of December 31, 2021 and 2020 are as follows:

	<u>December 31, 2021</u>	<u>December 31, 2020</u>
Policy reserve	₩ 54,330,046	53,391,401
Policyholder's equity adjustment	3,452	68,829
	<u>₩ 54,333,498</u>	<u>53,460,230</u>

(f) Policy reserve as of December 31, 2021 and 2020 are as follows:

	<u>December 31, 2021</u>	<u>December 31, 2020</u>
Variable interest rate	₩ 29,399,446	29,977,303
Fixed interest rate	24,930,600	23,414,098
	<u>₩ 54,330,046</u>	<u>53,391,401</u>

SHINHAN FINANCIAL GROUP CO., LTD. AND SUBSIDIARIES

Notes to the Consolidated Financial Statements

December 31, 2021 and 2020

(In millions of won)

27. Liability under insurance contracts (continued)

(g) The details of policy reserves for insurance risk classification as of December 31, 2021 and 2020 are as follows:

	December 31, 2021							
	Individual insurance				Group insurance			
	Pure endowment	Death	Endowment	Subtotal	Pure protection	Savings	Subtotal	Total
Premium reserve	₩ 14,515,676	28,443,718	9,078,015	52,037,409	15,609	64	15,673	52,053,082
Guarantee reserve	24,717	284,474	871	310,062	-	-	-	310,062
Unearned premium reserve	1	1,660	-	1,661	8	-	8	1,669
Reserve for outstanding claims	266,157	1,137,858	424,897	1,828,912	14,376	-	14,376	1,843,288
Interest rate difference guarantee reserve	1,734	130	7	1,871	-	-	-	1,871
Mortality gains reserve	6,894	34,085	88	41,067	2	-	2	41,069
Interest gains reserve	23,031	242	12	23,285	-	-	-	23,285
Expense gains reserve	6,068	7,595	-	13,663	-	-	-	13,663
Long term duration dividend reserve	26,799	12,663	7	39,469	-	-	-	39,469
Reserve for policyholder's profit dividend	1,635	-	-	1,635	-	-	-	1,635
Reserve for losses on dividend insurance contract	953	-	-	953	-	-	-	953
	₩ 14,873,665	29,922,425	9,503,897	54,299,987	29,995	64	30,059	54,330,046

SHINHAN FINANCIAL GROUP CO., LTD. AND SUBSIDIARIES

Notes to the Consolidated Financial Statements

December 31, 2021 and 2020

(In millions of won)

27. Liability under insurance contracts (continued)

(g) The details of policy reserves for insurance risk classification as of December 31, 2021 and 2020 are as follows (continued):

	December 31, 2020							
	Individual insurance				Group insurance			
	Pure endowment	Death	Endowment	Subtotal	Pure protection	Savings	Subtotal	Total
Premium reserve	₩ 14,597,735	26,634,537	9,981,880	51,214,152	18,430	62	18,492	51,232,644
Guarantee reserve	28,168	267,154	762	296,084	-	-	-	296,084
Unearned premium reserve	1	1,640	-	1,641	13	-	13	1,654
Reserve for outstanding claims	240,324	1,111,052	363,688	1,715,064	15,384	-	15,384	1,730,448
Interest rate difference guarantee reserve	1,937	141	9	2,087	-	-	-	2,087
Mortality gains reserve	7,865	37,553	124	45,542	1	-	1	45,543
Interest gains reserve	23,651	256	14	23,921	-	-	-	23,921
Expense gains reserve	6,606	8,336	-	14,942	-	-	-	14,942
Long term duration dividend reserve	28,737	13,775	12	42,524	-	-	-	42,524
Reserve for policyholder's profit dividend	1,080	-	-	1,080	-	-	-	1,080
Reserve for losses on dividend insurance contract	474	-	-	474	-	-	-	474
	₩ 14,936,578	28,074,444	10,346,489	53,357,511	33,828	62	33,890	53,391,401

SHINHAN FINANCIAL GROUP CO., LTD. AND SUBSIDIARIES

Notes to the Consolidated Financial Statements

December 31, 2021 and 2020

(In millions of won)

27. Liability under insurance contracts (continued)

(h) Changes in policy reserves

Changes in policy reserves for the year ended December 31, 2021 and 2020 are as follows:

		December 31, 2021		
		Insurance contracts with fixed-interest	Insurance contracts with variable-interest	Total
Beginning balance	₩	23,414,098	29,977,303	53,391,401
Reserve (*)		1,516,502	(577,857)	938,645
Ending balance	₩	24,930,600	29,399,446	54,330,046

(*) This is the amount of provision for insurance contract liabilities less changes in reinsurance assets.

		December 31, 2020		
		Insurance contracts with fixed-interest	Insurance contracts with variable-interest	Total
Beginning balance	₩	22,028,112	30,058,020	52,086,132
Reserve (*)		1,385,986	(80,717)	1,305,269
Ending balance	₩	23,414,098	29,977,303	53,391,401

(*) This is the amount of provision for insurance contract liabilities less changes in reinsurance assets.

(i) Changes in policy reserves by insurance risk classification

Changes in policy reserves by insurance risk classification for the year ended December 31, 2021 and 2020 are as follows:

		December 31, 2021							
		Individual insurance				Group insurance			Total
		Pure endowment	Death	Endowment	Subtotal	Pure protection	Savings	Sub total	
Beginning balance	₩	14,936,578	28,074,444	10,346,489	53,357,511	33,828	62	33,890	53,391,401
Reserve (reversal) (*)		(62,913)	1,847,981	(842,592)	942,476	(3,833)	2	(3,831)	938,645
Ending balance	₩	14,873,665	29,922,425	9,503,897	54,299,987	29,995	64	30,059	54,330,046

(*) This is the amount of provision for insurance contract liabilities less changes in reinsurance assets.

		December 31, 2020							
		Individual insurance				Group insurance			Total
		Pure endowment	Death	Endowment	Subtotal	Pure protection	Savings	Sub total	
Beginning balance	₩	14,986,916	26,382,609	10,677,484	52,047,009	39,063	60	39,123	52,086,132
Reserve (reversal) (*)		(50,338)	1,691,835	(330,995)	1,310,502	(5,235)	2	(5,233)	1,305,269
Ending balance	₩	14,936,578	28,074,444	10,346,489	53,357,511	33,828	62	33,890	53,391,401

(*) This is the amount of provision for insurance contract liabilities less changes in reinsurance assets.

SHINHAN FINANCIAL GROUP CO., LTD. AND SUBSIDIARIES

Notes to the Consolidated Financial Statements

December 31, 2021 and 2020

(In millions of won)

27. Liability under insurance contracts (continued)

(j) Reinsurance credit risk as of December 31, 2021 and 2020 are as follows:

	December 31, 2021		December 31, 2020	
	Reinsurance assets	Reinsurance account receivable	Reinsurance assets	Reinsurance account receivable
AAA	₩ -	-	10,611	47,690
AA- to AA+	15,310	23,472	29,294	23,348
A- to A+	31,740	46,615	2,375	4,018
	₩ 47,050	70,087	42,280	75,056

(k) Income or expenses on insurance for the years ended December 31, 2021 and 2020 are as follows:

	December 31, 2021	December 31, 2020
Insurance income:		
Premium income	₩ 6,255,872	7,037,308
Reinsurance income	153,534	152,892
Separate account income	75,117	57,553
	6,484,523	7,247,753
Insurance expenses:		
Claims paid	5,346,364	5,564,875
Reinsurance premium expenses	175,282	167,215
Provision for policy reserves (*)	933,875	1,311,252
Separate account expenses	75,116	57,553
Acquisition costs	687,469	802,942
Collection expenses and discount fee	16,810	19,922
Deferred acquisition costs	(397,196)	(486,972)
Amortization of deferred acquisition costs	422,189	414,898
	7,259,909	7,851,685
Net loss on insurance	₩ (775,386)	(603,932)

(*) Interest expenses on savings insurance contracts are included.

SHINHAN FINANCIAL GROUP CO., LTD. AND SUBSIDIARIES

Notes to the Consolidated Financial Statements

December 31, 2021 and 2020

(In millions of won)

27. Liability under insurance contracts (continued)

(l) Maturity of premium reserve as of December 31, 2021 and 2020 are as follows:

		December 31, 2021						
		Less than or equal to 1 year	1 ~ 3 years	3 ~ 7 years	7 ~ 10 years	10 ~ 20 years	More than 20 years	Total
Variable interest rate	₩	906,017	1,492,275	1,420,942	653,388	2,001,348	20,082,744	26,556,714
Fixed interest rate		99,289	471,909	772,549	687,077	2,072,122	21,393,422	25,496,368
Ending balance	₩	1,005,306	1,964,184	2,193,491	1,340,465	4,073,470	41,476,166	52,053,082

		December 31, 2020						
		Less than or equal to 1 year	1 ~ 3 years	3 ~ 7 years	7 ~ 10 years	10 ~ 20 years	More than 20 years	Total
Variable interest rate	₩	929,268	1,944,710	1,819,554	820,964	2,056,906	19,729,536	27,300,938
Fixed interest rate		164,890	418,574	983,635	594,667	2,090,669	19,679,271	23,931,706
Ending balance	₩	1,094,158	2,363,284	2,803,189	1,415,631	4,147,575	39,408,807	51,232,644

(m) Liability adequacy test, LAT – Shinhan Life Insurance Co., Ltd.

i) Scope

Liability adequacy tests are performed on the premium reserve, unearned premium reserve and guarantee reserve for the contracts held at December 31, 2021. The premium reserve considered the amount net level premium reserve less, where appropriate, deferred acquisition cost in accordance with the article 6-3 of Regulation on Supervision of Insurance Business Act.

ii) Output overview

In the debt appraisal system, the insurance premium surplus method is applied to calculate premium deficits. Premium deficiency refers to deficiency when the amount of accumulated reserve is insufficient due to a decrease in the interest rate after the sale of the product or an increase in the risk rate compared with the expected basic rate at the time of product development.

The insurance premium standard inspection method is a method of calculating the reserve amount based on the present value of total income reflecting the interest rate, the risk rate, the business ratio, the cancellation rate, etc. and the present value of the total expenditure, that is, interest rate(discount rate), business ratio, risk rate, and cancellation rate calculated based on the Group's own experience, which reflects company-specific characteristics, and does not reflect subjective factors such as management's willingness to improve management.

SHINHAN FINANCIAL GROUP CO., LTD. AND SUBSIDIARIES

Notes to the Consolidated Financial Statements

December 31, 2021 and 2020

(In millions of won)

27. Liability under insurance contracts (continued)

(i) Liability adequacy test, LAT – Shinhan Life Insurance Co., Ltd. (continued)

iii) Assumptions and basis of calculation applied

The assumptions and basis of calculation applied to calculate the estimates of future cash flows when performing liability adequacy test for the year ended December 31, 2021 and 2020 are as follows. The criteria of Insurance contract liability adequacy test were changed during the period, and the Group has applied the change in the accounting policy as it provides more reliable and relevant information on the estimate of future cash flows, and the comparative figures with the prior period disclosed in the notes have been rewritten.

	Assumptions			Assumption applied and calculation method
	December 31, 2021	December 31, 2020	January 1, 2020	
Discount rate	-3.39% ~ 19.541%	Shinhan Life Insurance Co., Ltd. -3.623% ~ 23.477% Orange Life Insurance Co., Ltd. -3.623% ~ 23.477%	Shinhan Life Insurance Co., Ltd. -2.861% ~ 16.336% Orange Life Insurance Co., Ltd. -2.861% ~ 16.336%	The interest rate scenario calculated and presented by the Financial Supervisory Service as a scenario in which a liquidity premium is added to the risk-free rate of return scenario. (Shinhan Life Insurance) · Death due to other causes: Based on the statistics illustrating the past five-year experience, the ratio of premiums to on-level risk premiums by risk collateral and time elapsed.
Mortality rate	16% ~ 751%	Shinhan Life Insurance Co., Ltd. 10.38% ~ 585.90% Orange Life Insurance Co., Ltd. 15% ~ 255%	Shinhan Life Insurance Co., Ltd. 11.36% ~ 497.99% Orange Life Insurance Co., Ltd. 20% ~ 255%	· Death due to natural causes: The ratio of actual mortality to the latest expected mortality (Orange Life Insurance) Based on the statistics illustrating the past five-year experience or more, it is calculated by reflecting the trend in the ratio of claims paid to expected claims by collateral, gender, product group, and time elapsed.
Surrender ratio	0% ~ 84%	Shinhan Life Insurance Co., Ltd. 0.53% ~ 29.83% Orange Life Insurance Co., Ltd. 0% ~ 61%	Shinhan Life Insurance Co., Ltd. 0.76% ~ 33.03% Orange Life Insurance Co., Ltd. 0% ~ 50%	Lapse rate by sales channel, product, and time elapsed for the past five years.

SHINHAN FINANCIAL GROUP CO., LTD. AND SUBSIDIARIES

Notes to the Consolidated Financial Statements

December 31, 2021 and 2020

(In millions of won)

27. Liability under insurance contracts (continued)

(i) Liability adequacy test, LAT – Shinhan Life Insurance Co., Ltd. (continued)

iv) The result of liability adequacy test as of December 31, 2021 and 2020, and January 1, 2020 are as follows:

				December 31, 2021		
				Provisions for test	LAT base	Premium surplus (loss)
Participating:						
Fixed interest	₩	1,371,625	2,098,387	(726,762)		
Variable interest		2,099,040	3,024,911	(925,871)		
Non- Participating:						
Fixed interest		18,749,426	8,155,797	10,593,629		
Variable interest		23,059,035	21,378,217	1,680,818		
Variable type		109,753	(1,437,388)	1,547,141		
	₩	45,388,879	33,219,924	12,168,955		

< Shinhan Life Insurance >

				December 31, 2020		
				Provisions for test	LAT base	Premium surplus (loss)
Participating:						
Fixed interest	₩	598,793	1,371,496	(772,703)		
Variable interest		915,382	1,062,384	(147,002)		
Non- Participating:						
Fixed interest		7,230,482	4,222,670	3,007,812		
Variable interest		14,456,394	13,753,963	702,431		
Variable type		165,259	61,212	104,047		
	₩	23,366,310	20,471,725	2,894,585		

<Orange Life Insurance >

				December 31, 2020		
				Provisions for test	LAT base	Premium surplus (loss)
Participating:						
Fixed interest	₩	745,614	793,719	(48,105)		
Variable interest		1,174,807	1,698,984	(524,177)		
Non- Participating:						
Fixed interest		10,061,004	5,850,160	4,210,844		
Variable interest		9,190,507	8,998,793	191,714		
Variable type		(15,032)	(1,548,878)	1,533,846		
	₩	21,156,900	15,792,778	5,364,122		

SHINHAN FINANCIAL GROUP CO., LTD. AND SUBSIDIARIES

Notes to the Consolidated Financial Statements

December 31, 2021 and 2020

(In millions of won)

27. Liability under insurance contracts (continued)

(i) Liability adequacy test, LAT – Shinhan Life Insurance Co., Ltd. (continued)

iv) The result of liability adequacy test as of December 31, 2021 and 2020 and January 1, 2020 are as follows (continued):

< Shinhan Life Insurance >

	January 1, 2020		
	Provisions for test	LAT base	Premium surplus (loss)
Participating:			
Fixed interest	₩ 595,317	1,367,648	(772,331)
Variable interest	900,378	1,082,341	(181,963)
Non- Participating:			
Fixed interest	6,608,221	4,199,666	2,408,555
Variable interest	14,481,696	13,770,288	711,408
Variable type	81,369	(28,011)	109,380
	₩ 22,666,981	20,391,932	2,275,049

<Orange Life Insurance >

	January 1, 2020		
	Provisions for test	LAT base	Premium surplus (loss)
Participating:			
Fixed interest	₩ 716,607	762,204	(45,597)
Variable interest	1,134,245	1,651,134	(516,889)
Non- Participating:			
Fixed interest	9,296,542	5,795,590	3,500,952
Variable interest	9,236,731	9,142,918	93,813
Variable type	(268,818)	(1,877,845)	1,609,027
	₩ 20,115,307	15,474,001	4,641,306

SHINHAN FINANCIAL GROUP CO., LTD. AND SUBSIDIARIES

Notes to the Consolidated Financial Statements

December 31, 2021 and 2020

(In millions of won)

28. Other liabilities

Other liabilities as of December 31, 2021 and 2020 are as follows:

	<u>December 31, 2021</u>	<u>December 31, 2020</u>
Lease liabilities(*)	₩ 612,690	594,161
Accounts payable	14,041,740	14,568,962
Accrued expenses	3,273,939	3,054,247
Dividend payable	32,275	32,508
Advance received	177,121	164,885
Unearned income	397,010	317,283
Withholding value-added tax and other taxes	673,294	692,719
Securities deposit received	1,985,269	2,198,722
Foreign exchange settlement pending	221,521	259,138
Domestic exchange settlement pending	1,890,408	5,745,338
Payable from trust account	5,191,901	5,086,459
Due to agencies	887,400	790,486
Deposits for subscription	133,550	148,506
Separate account liabilities	9,834,895	10,120,258
Sundry liabilities	1,563,832	1,617,449
Others	126,455	185,027
Present value discount	(52,464)	(49,935)
	<u>₩ 40,990,836</u>	<u>45,526,213</u>

(*) As of December 31, 2021, the Group accounts for the lease liabilities as other liabilities. For the year ended December 31, 2021, the amount of variable lease payments that are not included in the measurement of lease liabilities is ₩79 million, cash outflows from leases are ₩ 283,470 million, and interest expense on lease liabilities is ₩10,873 million.

SHINHAN FINANCIAL GROUP CO., LTD. AND SUBSIDIARIES

Notes to the Consolidated Financial Statements

December 31, 2021 and 2020

(In millions of won)

29. Equity

(a) Equity as of December 31, 2021 and 2020 are as follows:

	<u>December 31, 2021</u>	<u>December 31, 2020</u>
Capital stock:		
Common stock(*1)	₩ 2,608,176	2,608,176
Preferred stock	361,465	361,465
	<u>2,969,641</u>	<u>2,969,641</u>
Hybrid bond	3,334,531	2,179,934
Capital surplus:		
Share premium	11,352,819	11,352,924
Others	742,224	882,015
	<u>12,095,043</u>	<u>12,234,939</u>
Capital adjustments	(664,429)	(687,935)
Accumulated other comprehensive income, net of tax:		
Gain(loss) on financial assets at fair value through other comprehensive income	(614,872)	226,811
Gain on financial assets at fair value through profit or loss (Overlay approach)	141,821	161,919
Equity in other comprehensive income of associates	7,595	4,849
Foreign currency translation adjustments for foreign operations	(125,219)	(377,061)
Net loss from cash flow hedges	(26,471)	(48,171)
Other comprehensive income(loss) of separate account	(22,850)	18,423
Remeasurement of defined benefit obligation	(343,124)	(385,780)
Changes in own credit risk on financial liabilities designated under fair value option	(1,816)	(5,171)
	<u>(984,936)</u>	<u>(404,181)</u>
Retained earnings(*2),(*3),(*4)	30,541,300	27,777,169
Non-controlling interest(*5),(*6),(*7)	2,247,272	2,287,291
	<u>₩ 49,538,422</u>	<u>46,356,858</u>

(*1) For the year ended December 31, 2020, it increased due to common stock and third-party allocation paid-in capital increase issued when the Group acquired residual shares of Orange Life Insurance Co., Ltd and Shinhan Venture Investment Co., Ltd. The cost deducted from the issuing capital is ₩13,300 million. Affinity Equity Partners and Baring Private Equity Asia who have participated in third-party allocation-based capital increase have a right to practically appoint one director, respectively.

(*2) As of December 31, 2021 and 2020, profits reserved by the Group as of Article 53 of the Financial Holding Companies Act amounted to ₩2,432,039 million and ₩2,304,595 million, respectively.

(*3) As of December 31, 2021 and 2020, the regulatory reserves for loan losses the Group appropriated in retained earnings are ₩15,552 million and ₩11,988 million, respectively.

(*4) As of December 31, 2021, profit dividends within retained earnings of subsidiaries of the Group restricted in accordance with laws, etc. are amounted to ₩7,265,086 million.

(*5) As of December 31, 2021 and 2020, the total amounts of hybrid bonds that Shinhan Bank, Jeju Bank, Shinhan Capital Co.,Ltd. and Shinhan Life Insurance Co., Ltd. have recognized as non-controlling interests are ₩2,035,762 million and ₩2,035,762 million, respectively. And, for the years ended December 31, 2021 and 2020, the amounts of dividends paid for the hybrid bonds by Shinhan Bank, Jeju Bank, Shinhan Capital Co.,Ltd. and Shinhan Life Insurance Co., Ltd. ₩71,746 million and ₩54,619 million, respectively, are allocated to profit attributed to non-controlling interest.

(*6) The non-controlling interests of ₩59,709 million decreased for the year ended December 31, 2021 due to the acquisition of the remaining shares of Shinhan Asset Management Co., Ltd.

(*7) The non-controlling interests of ₩1,330,337 million decreased for the year ended December 31, 2020 due to the acquisition of the remaining shares of Orange Life Insurance Co., Ltd.

SHINHAN FINANCIAL GROUP CO., LTD. AND SUBSIDIARIES

Notes to the Consolidated Financial Statements

December 31, 2021 and 2020

(In millions of won, except per share data)

29. Equity (continued)

(b) Capital stock

Capital stock of the Group as of December 31, 2021 and 2020 are as follows:

Number of authorized shares	1,000,000,000
Par value per share in won	₩ 5,000
Number of issued common stocks as of December 31, 2021	516,599,554
Number of issued common stocks as of December 31, 2020	516,599,554
Number of issued preferred stocks as of December 31, 2021 and 2020	17,482,000

The details of changes in the number of common shares outstanding as of December 31, 2021 and 2020 are as follows:

	<u>December 31, 2021</u>	<u>December 31, 2020</u>
Beginning balance	515,894,758	460,317,525
Increase	700,870	60,626,827
Decrease	(2,426)	(5,049,594)
Ending balance	516,593,202	515,894,758

(c) The details of preferred stock are as follows:

	<u>The number of shares</u>	<u>Contracted dividend rate</u>	<u>Conversion request period(*)</u>
Convertible preferred stock	17,482,000	4.0% per year based on issue price (non-cumulative participating)	2020.05.01~2023.04.30

(*) Preferred stocks that have not been converted for 4 years from the issuance date and until the expiration date of the period of existence are automatically converted to common stocks at the expiration date of the period of existence.

SHINHAN FINANCIAL GROUP CO., LTD. AND SUBSIDIARIES
Notes to the Consolidated Financial Statements

December 31, 2021 and 2020

(In millions of won, except per share data)

29. Equity (continued)

(d) Hybrid bonds

Hybrid bonds classified as other equity instruments as of December 31, 2021 and 2020 are as follows:

	<u>Issue date</u>	<u>Maturity date</u>	<u>Interest rate (%)</u>		<u>December 31, 2021</u>	<u>December 31, 2020</u>
	June 25, 2015	June 25, 2045	4.38	₩	199,455	199,455
	September 15, 2017	-	3.77		134,683	134,683
	September 15, 2017	-	4.25		89,783	89,783
	April 13, 2018	-	4.08		134,678	134,678
KRW	April 13, 2018	-	4.56		14,955	14,955
	August 29, 2018	-	4.15		398,679	398,679
	June 28, 2019	-	3.27		199,476	199,476
	September 17, 2020	-	3.12		448,699	448,699
	March 16, 2021	-	2.94		429,009	-
	March 16, 2021	-	3.30		169,581	-
USD	August 13, 2018	-	5.88		559,526	559,526
	May 12, 2021	-	2.88		556,007	-
				₩	<u>3,334,531</u>	<u>2,179,934</u>

(*) For the year ended December 31, 2021, the deduction for capital related to hybrid bonds issued is ₩4,953 million.

The hybrid bonds above can be repaid early after 5 or 10 years from the date of issuance, and the controlling company has an unconditional right to extend the maturity under the same condition. In addition, if no dividend is to be paid for common stocks, the agreed interest is also not paid.

(e) Capital adjustments

Changes in capital adjustments for the years ended December 31, 2021 and 2020 are as follows:

		<u>December 31, 2021</u>	<u>December 31, 2020</u>
Beginning balance	₩	(687,935)	(1,116,770)
Acquisition of treasury stocks		(79)	(150,467)
Disposal and retirement of treasury stocks		23,589	601,809
The acquisition commitment amount for subsidiaries' remaining shares		-	(22,019)
Other transactions with owners		(4)	(488)
Ending balance	₩	<u>(664,429)</u>	<u>(687,935)</u>

SHINHAN FINANCIAL GROUP CO., LTD. AND SUBSIDIARIES

Notes to the Consolidated Financial Statements

December 31, 2021 and 2020

(In millions of won)

29. Equity (continued)

(e) Accumulated other comprehensive income

Changes in accumulated other comprehensive income for the years ended December 31, 2021 and 2020 are as follows:

	December 31, 2021										
	Items that are or may be reclassified to profit or loss						Items that will never be reclassified to profit or loss				
	Gain (loss) on securities at fair value through other comprehensive income	Gain (loss) on valuation of financial asset measured at FVTPL (overlay approach)	Equity in other comprehensive income (loss) of associates	Foreign currency translation adjustments for foreign operations	Net gain (loss) from cash flow hedges	Other comprehensive income (loss) of separate account	Remeasurements of the defined benefit plans	Equity in other comprehensive income (expense) of associates	Gain (loss) on securities at fair value through other comprehensive income	Gain (loss) on financial Liabilities measured at FVTPL attributable to changes in credit risk	Total
Beginning balance	₩ 146,829	161,919	4,875	(377,061)	(48,171)	18,423	(385,780)	(26)	79,982	(5,171)	(404,181)
Change due to fair value	(1,110,290)	(31,924)	6,517	-	-	(56,484)	-	(3)	21,408	(1,526)	(1,172,302)
Reclassification:											
Change due to impairment or disposal	(114,399)	-	-	-	-	-	-	-	-	-	(114,399)
Effect of hedge accounting	-	-	-	-	(209,869)	-	-	-	-	-	(209,869)
Hedging	10,627	-	-	(74,525)	239,800	-	-	-	-	-	175,902
Effects from changes in foreign exchange rate	-	-	-	333,059	-	-	-	-	673	-	333,732
Remeasurements of the defined benefit plans	-	-	-	-	-	-	59,441	-	-	-	59,441
Deferred income taxes	334,391	11,826	(3,769)	(6,226)	(8,231)	15,211	(16,164)	1	(16,061)	(1,272)	309,706
Transfer to other account	-	-	-	-	-	-	-	-	29,421	6,153	35,574
Non-controlling interests	2,547	-	-	(466)	-	-	(621)	-	-	-	1,460
Ending balance	₩ (730,295)	141,821	7,623	(125,219)	(26,471)	(22,850)	(343,124)	(28)	115,423	(1,816)	(984,936)

SHINHAN FINANCIAL GROUP CO., LTD. AND SUBSIDIARIES

Notes to the Consolidated Financial Statements

December 31, 2021 and 2020

(In millions of won)

29. Equity (continued)

(e) Accumulated other comprehensive income (continued)

Changes in accumulated other comprehensive income for the years ended December 31, 2021 and 2020 are as follows (continued):

	December 31, 2020										
	Items that are or may be reclassified to profit or loss					Items that will never be reclassified to profit or loss					Total
	Gain (loss) on securities at fair value through other comprehensive income	Gain (loss) on valuation of financial asset measured at FVTPL (overlay approach)	Equity in other comprehensive income (loss) of associates	Foreign currency translation adjustments for foreign operations	Net gain (loss) from cash flow hedges	Other comprehensive income (loss) of separate account	Remeasurements of the defined benefit plans	Equity in other comprehensive income (expense) of associates	Gain (loss) on securities at fair value through other comprehensive income	Gain (loss) on financial Liabilities measured at FVTPL attributable to changes in credit risk	
Beginning balance	₩ 233,328	71,621	8,193	(217,465)	(33,711)	14,539	(401,532)	(16)	73,142	(8,255)	(260,156)
Change due to fair value	(3,601)	125,298	(1,080)	-	-	5,358	-	(15)	(19,133)	(9,689)	97,138
Reclassification:											
Change due to impairment or disposal	(105,274)	-	-	5,858	-	-	-	-	-	13,942	(85,474)
Effect of hedge accounting	-	-	-	-	144,750	-	-	-	-	-	144,750
Hedging	(4,395)	-	-	45,083	(164,708)	-	-	-	-	-	(124,020)
Effects from changes in foreign exchange rate	-	74	(355)	(219,306)	-	-	-	-	721	-	(218,866)
Remeasurements of the defined benefit plans	-	-	-	-	-	-	21,422	-	-	-	21,422
Deferred income taxes	26,486	(35,074)	(1,883)	7,000	5,498	(1,474)	(5,610)	5	(2,573)	(1,169)	(8,794)
Transfer to other account	-	-	-	-	-	-	-	-	27,825	-	27,825
Non-controlling interests	285	-	-	1,769	-	-	(60)	-	-	-	1,994
Ending balance	₩ 146,829	161,919	4,875	(377,061)	(48,171)	18,423	(385,780)	(26)	79,982	(5,171)	(404,181)

SHINHAN FINANCIAL GROUP CO., LTD. AND SUBSIDIARIES

Notes to the Consolidated Financial Statements

December 31, 2021 and 2020

(In millions of won)

29. Equity (continued)

(f) Appropriation of retained earnings

The appropriation of retained earnings for the years ended December 31, 2021 and 2020 are as follows:

Date of appropriation:	December 31, 2021	December 31, 2020
	March 24, 2022	March 25, 2021
Unappropriated retained earnings:		
Balance at beginning of year	₩ 5,355,358	5,251,413
Retirement of treasury stock	-	(150,325)
Dividend to hybrid bonds	(116,388)	(85,327)
Interim dividends	(299,082)	-
Net income	1,413,956	1,274,443
	<u>6,353,844</u>	<u>6,290,204</u>
Appropriation of retained earnings:		
Legal reserve	(141,396)	(127,444)
Dividends		
Dividends on common stocks paid	(723,230)	(773,839)
Dividends on preferred stocks paid	(24,475)	(29,999)
Regulatory reserve for loan losses	(2,972)	(3,564)
	<u>(892,073)</u>	<u>(934,846)</u>
Unappropriated retained earnings to be carried over to subsequent year	₩ <u>5,461,771</u>	<u>5,355,358</u>

(*) These statements of appropriation of retained earnings are based on the separate financial statements of Shinhan Finance Group.

(g) Regulatory reserve for loan losses

In accordance with Regulations for the Supervision of Financial Institutions, the Group reserves the difference between allowance for credit losses by K-IFRS and that as required by the Regulations at the account of regulatory reserve for loan losses in retained earnings.

i) Changes in regulatory reserve for loan losses including non-controlling interests as of December 31, 2021 and 2020 are as follows:

	December 31, 2021	December 31, 2020
Beginning balance	₩ 3,329,899	3,161,170
Planned regulatory reversal of loan losses	269,743	168,729
Ending balance	<u>₩ 3,599,642</u>	<u>3,329,899</u>

SHINHAN FINANCIAL GROUP CO., LTD. AND SUBSIDIARIES

Notes to the Consolidated Financial Statements

December 31, 2021 and 2020

(In millions of won, except per share data)

29. Equity (continued)

(g) Regulatory reserve for loan losses (continued)

ii) Profit attributable to equity holders of Shinhan Financial Group and earnings per share after factoring in regulatory reserve for loan losses for the years ended December 31, 2021 and 2020 are as follows:

		<u>December 31, 2021</u>	<u>December 31, 2020</u>
Profit attributable to equity holders of Shinhan Financial Group	₩	4,019,254	3,414,595
Provision for regulatory reserve for loan losses		(269,085)	(177,620)
Profit attributable to equity holders of Shinhan Financial Group adjusted for regulatory reserve	₩	<u>3,750,169</u>	<u>3,236,975</u>
Basic and diluted earnings per share adjusted for regulatory reserve in won(*)		6,804	6,299

(*) Dividends for hybrid bonds are deducted.

(h) Treasury stock

The acquisitions of treasury stock for the years ended December 31, 2021 and 2020 are as follows:

	<u>December 31, 2021</u>		<u>December 31, 2020(*)</u>	
	<u>The number of share</u>	<u>Carrying value</u>	<u>The number of share</u>	<u>Carrying value</u>
Beginning balance	704,796 ₩	28,215	13,882,062 ₩	600,000
Acquisition	2,426	79	5,049,594	150,467
Disposal	700,870	(28,067)	13,191,202	(572,252)
Retirement	-	-	5,035,658	(150,000)
Ending balance	<u>6,352 ₩</u>	<u>227</u>	<u>704,796 ₩</u>	<u>28,215</u>

(*) Changes in equity shares due to the exchange of shares with Orange Life Insurance Co., Ltd. and Shinhan Venture Investment Co., Ltd. are included in the acquisition and disposal for treasury stock. Shares of Shinhan Financial Group Co., Ltd. is owned by Orange Life Insurance Co., Ltd. and Shinhan Venture Investment Co., Ltd. are included in its own shares.

SHINHAN FINANCIAL GROUP CO., LTD. AND SUBSIDIARIES

Notes to the Consolidated Financial Statements

December 31, 2021 and 2020

(In millions of won, except per share data)

30. Dividends

(a) For the year ended December 31, 2021, the interim dividends paid are as follows.:

Dividend base date		Amount
2 ND Quarter	Common stock (₩300 per share)	₩ 154,978
	Convertible preferred stock (₩300 per share)	5,245
		₩ 160,223
3 rd Quarter	Common stock (₩260 per share)	₩ 134,314
	Convertible preferred stock (₩260 per share)	4,545
		₩ 138,859

(*) The Group has amended the articles of association by resolution of the general meeting of stockholders on March 25, 2021 and the Group has been offering interim dividends since June 30, 2021.

(b) Details of dividends recognized as distributions to stockholders for the years ended December 31, 2021 and 2020 are as follows:

	December 31, 2021(*1)	December 31, 2020
Common Stock:		
Total number of shares issued and outstanding	516,599,554	516,599,554
Par value per share in won	5,000	5,000
Dividend per share in won	1,400	1,500
Dividends(*2)	₩ 723,230	773,839
Dividend rate per share	% 28.0	30.0
Preferred Stock:		
Total number of shares issued and outstanding	17,482,000	17,482,000
Par value per share in won	5,000	5,000
Dividend per share in won	1,400	1,716
Dividends	₩ 24,475	29,999
Dividend rate per share	% 28.0	34.3

(*1) The current dividend(plan) will be decided on March 24, 2022. The amount of dividends was not recognized as a distribution to the owner during the period.

(*2) Dividends on own shares held by the Group are excluded.

(c) The details of dividends paid by the Group related to the preferred stock issued for the year ended December 31, 2021 are as follows:

Number of shares	Dividend per share (in won)	Total dividend paid	Issue price per share (in won)	Dividend rate per issue price (%)
17,482,000	1,960	34,265	42,900	4.57

(d) Dividends for hybrid bond is calculated as follows for the years ended December 31, 2021 and 2020:

	December 31, 2021	December 31, 2020
Amount of hybrid bond	₩ 3,347,700	2,188,150
Interest rate (%)	% 2.88 ~ 5.88	3.12 ~ 5.88
Dividends	₩ 116,388	85,327

SHINHAN FINANCIAL GROUP CO., LTD. AND SUBSIDIARIES

Notes to the Consolidated Financial Statements

December 31, 2021 and 2020

(In millions of won)

31. Net interest income

Net interest income for the years ended December 31, 2021 and 2020 are as follows:

	<u>December 31, 2021</u>	<u>December 31, 2020</u>
Interest income:		
Cash and deposits at amortized cost	₩ 85,846	128,023
Deposits at FVTPL	1,298	13,888
Securities at FVTPL	659,927	742,958
Securities at FVOCI	896,027	957,817
Securities at amortized cost	1,091,974	1,076,849
Loans at amortized cost	11,889,767	11,697,775
Loans at FVTPL	35,587	73,991
Others	63,804	82,695
	<u>14,724,230</u>	<u>14,773,996</u>
Interest expense:		
Deposits	2,173,804	2,842,625
Borrowings	330,548	426,607
Debt securities issued	1,390,230	1,554,544
Others	60,323	67,520
	<u>3,954,905</u>	<u>4,891,296</u>
Net interest income	₩ <u>10,769,325</u>	<u>9,882,700</u>

SHINHAN FINANCIAL GROUP CO., LTD. AND SUBSIDIARIES

Notes to the Consolidated Financial Statements

December 31, 2021 and 2020

(In millions of won)

32. Net fees and commission income

Net fees and commission income for the years ended December 31, 2021 and 2020 are as follows:

	<u>December 31, 2021</u>	<u>December 31, 2020</u>
Fees and commission income:		
Credit placement fees	₩ 71,480	94,836
Commission received as electronic charge receipt	148,626	143,449
Brokerage fees	577,238	546,236
Commission received as agency	146,662	145,162
Investment banking fees	188,644	161,439
Commission received in foreign exchange activities	271,808	239,467
Trust management fees	310,376	255,043
Credit card fees	1,175,084	1,170,078
Operating lease fees(*)	365,447	245,173
Others	884,520	813,591
	<u>4,139,885</u>	<u>3,814,474</u>
Fees and commission expense:		
Credit-related fee	38,668	46,456
Credit card fees	836,990	849,256
Others	589,230	535,829
	<u>1,464,888</u>	<u>1,431,541</u>
Net fees and commission income	₩ <u>2,674,997</u>	<u>2,382,933</u>

(*) Among operating lease fees recognized for the years ended December 31, 2021 and 2020, there is no variable lease fee income which does not vary by index or rate.

33. Dividend income

Dividend income for the years ended December 31, 2021 and 2020 are as follows:

	<u>December 31, 2021</u>	<u>December 31, 2020</u>
Securities at FVTPL	₩ 100,315	76,453
Securities at FVOCI	24,216	21,503
	<u>₩ 124,531</u>	<u>97,956</u>

SHINHAN FINANCIAL GROUP CO., LTD. AND SUBSIDIARIES

Notes to the Consolidated Financial Statements

December 31, 2021 and 2020

(In millions of won)

34. Net gain (loss) on financial instruments measured at fair value through profit or loss

Net gain(loss) on financial instruments measured at fair value through profit or loss for the ended December 31, 2021 and 2020 are as follows:

	<u>December 31, 2021</u>	<u>December 31, 2020</u>
Net gain (loss) on deposits measured at FVTPL		
Gain (loss) on valuation	₩ (296)	1,267
Gain (loss) on sale	(1,479)	28,461
	<u>(1,775)</u>	<u>29,728</u>
Net gain (loss) on loans measured at FVTPL		
Loss on valuation	(78,416)	(204,702)
Gain on sale	15,312	17,516
	<u>(63,104)</u>	<u>(187,186)</u>
Net gain (loss) on securities measured at FVTPL		
Debt securities		
Gain on valuation	97,281	41,208
Gain (loss) on sale	(92,230)	72,338
Other gains	506,980	331,837
	<u>512,031</u>	<u>445,383</u>
Equity securities		
Gain on valuation	180,363	134,922
Gain on sale	199,702	283,265
	<u>380,065</u>	<u>418,187</u>
Other		
Gain on valuation	9,316	22,690
	<u>901,412</u>	<u>886,260</u>
Net gain (loss) on financial liabilities measured at FVTPL		
Debt securities		
Loss on valuation	(7,745)	(48,261)
Gain (loss) on disposal	(67,522)	82,724
	<u>(75,267)</u>	<u>34,463</u>
Other		
Loss on valuation	(26,224)	(83,316)
Gain on disposal	3,489	8,313
	<u>(22,735)</u>	<u>(75,003)</u>
	<u>(98,002)</u>	<u>(40,540)</u>
Derivatives:		
Gain (loss) on valuation	(64,128)	245,681
Gain(loss) on transaction	429,228	(661,113)
	<u>365,100</u>	<u>(415,432)</u>
	₩ <u>1,103,631</u>	<u>272,830</u>

SHINHAN FINANCIAL GROUP CO., LTD. AND SUBSIDIARIES

Notes to the Consolidated Financial Statements

December 31, 2021 and 2020

(In millions of won)

35. Net gain (loss) on financial instruments designated at fair value through profit or loss

Net gain (loss) on financial instruments designated at fair value through profit or loss for the years ended December 31, 2021 and 2020 are as follows:

	<u>December 31, 2021</u>	<u>December 31, 2020</u>
Financial liabilities designated at fair value through profit or loss:		
Compound financial instruments :		
Gain on valuation	₩ 423,914	241,066
Loss on sale and redemption	(512,215)	(42,827)
	<u>₩ (88,301)</u>	<u>198,239</u>

36. Reversal of (provision for) credit loss allowance

Reversal of (provision for) credit loss allowance on financial assets for the years ended December 31, 2021 and 2020 are as follows:

	<u>December 31, 2021</u>	<u>December 31, 2020</u>
Allowance provided:		
Loans at amortized cost	₩ (907,070)	(1,290,695)
Other financial assets at amortized cost	(52,162)	(33,785)
Securities at fair value through other comprehensive income	(19,697)	(3,829)
Unused credit line and financial guarantee	-	(52,795)
Securities at amortized cost	(5,305)	(1,075)
	<u>(984,234)</u>	<u>(1,382,179)</u>
Allowance reversed:		
Unused credit commitment and financial guarantee	9,549	-
	<u>₩ (974,685)</u>	<u>(1,382,179)</u>

37. General and administrative expenses

General and administrative expenses for the years ended December 31, 2021 and 2020 are as follows:

	<u>December 31, 2021</u>	<u>December 31, 2020</u>
Employee benefits:		
Salaries	₩ 3,283,436	3,034,543
Severance benefits:		
Defined contribution	38,577	36,660
Defined benefit	192,614	184,753
Termination benefits	268,089	94,723
	<u>3,782,716</u>	<u>3,350,679</u>
Entertainment	38,552	34,963
Depreciation	490,457	475,506
Amortization	155,202	129,976
Taxes and utility bills	187,432	197,996
Advertising	280,780	204,308
Research	25,320	20,271
Others	782,629	798,774
	<u>₩ 5,743,088</u>	<u>5,212,473</u>

SHINHAN FINANCIAL GROUP CO., LTD. AND SUBSIDIARIES

Notes to the Consolidated Financial Statements

December 31, 2021 and 2020

(In millions of won, except per share data)

38. Share-based payments

(a) Stock options granted as of December 31, 2021 are as follows:

	<u>7th grant (*)</u>
Type	Cash payment
Grant date	March 19, 2008
Exercise price in Korean won	₩49,053
Number of shares granted	808,700
Options' expiry dates	May 17, 2021 / September 17, 2021
Changes in number of shares granted:	
Balance at January 1, 2021	36,162
Exercised	36,162
Balance at December 31, 2021	<u>-</u>

(b) Performance shares granted as of December 31, 2021 are as follows:

	<u>Expired</u>	<u>Not expired</u>
Type	Cash-settled share-based payment	
Performance conditions (*1)	Relative stock price linked (20.0%), management index (80.0%)	
Exercising period	4 years from the commencement date of the year to which the grant date belongs	
Estimated number of shares vested at December 31, 2021	578,201	1,941,484
Fair value per share in Korean won (*2)	₩40,580, ₩44,222, ₩33,122 and ₩37,387 for the expiration of exercising period from 2018 to 2021	₩ 36,800

(*1) Starting with the shares provided from 2020, Shinhan Financial Group and Shinhan Bank apply relative stock price linked (20.0%), management index (60.0%), and prudential index (20.0%).

(*2) Based on performance-based stock compensation, the reference stock price (the arithmetic average of the weighted average share price of transaction volume for the past two month, the previous one month, and the past one week) of four years after the commencement of the grant year is paid in cash, and the fair value of the reference stock to be paid in the future is assessed as the closing price of the settlement.

SHINHAN FINANCIAL GROUP CO., LTD. AND SUBSIDIARIES

Notes to the Consolidated Financial Statements

December 31, 2021 and 2020

(In millions of won)

38. Share-based payments (continued)

(c) Share-based compensation costs for the years ended December 31, 2021 and 2020 are as follows:

	December 31, 2021		
	Employees of		
	The controlling company	The subsidiaries	Total
Stock options granted:			
7th	₩ (1)	(1)	(2)
Performance shares	4,286	32,899	37,185
	₩ 4,285	32,898	37,183

	December 31, 2020		
	Employees of		
	The controlling company	The subsidiaries	Total
Stock options granted:			
6th	₩ (1)	(4)	(5)
7th	(18)	(26)	(44)
Performance shares	(257)	(3,902)	(4,159)
	₩ (276)	(3,932)	(4,208)

SHINHAN FINANCIAL GROUP CO., LTD. AND SUBSIDIARIES

Notes to the Consolidated Financial Statements

December 31, 2021 and 2020

(In millions of won)

38. Share-based payments (continued)

(d) Accrued expenses and the intrinsic value as of December 31, 2021 and 2020 are as follows:

	December 31, 2021		
	Accrued expense (*)		
	The controlling company	The subsidiaries	Total
Stock options granted:			
Performance shares	₩ 10,598	82,498	93,096

(*) As of December 31, 2021, all stock options have expired, and the fair value is considered as intrinsic value for performance shares, respectively.

	December 31, 2020		
	Accrued expense (*)		
	The controlling company	The subsidiaries	Total
Stock options granted:			
7th	₩ 1	1	2
Performance shares	7,201	60,241	67,442
	₩ 7,202	60,242	67,444

(*) The intrinsic value of share-based payments is ₩ 67,442 million as of December 31, 2020. For the calculation, the quoted market price of ₩ 32,050 per share is used for stock options and the fair value is considered as intrinsic value for performance shares, respectively.

SHINHAN FINANCIAL GROUP CO., LTD. AND SUBSIDIARIES

Notes to the Consolidated Financial Statements

December 31, 2021 and 2020

(In millions of won)

39. Net other operating expense

Other operating income and other operating expense for the years ended December 31, 2021 and 2020 are as follows:

	<u>December 31, 2021</u>	<u>December 31, 2020</u>
Other operating income		
Gain on disposal of assets:		
Loans at amortized cost	₩ 18,843	21,348
Others:		
Gain on hedged items	501,676	536,768
Reversal of allowance for guarantees and acceptances	-	2,709
Gain on other trust accounts	44,238	-
Reversal of other allowance	8,886	850
Others	356,611	164,999
	<u>911,411</u>	<u>705,326</u>
	₩ <u>930,254</u>	<u>726,674</u>
Other operating expense		
Loss on disposal of assets:		
Loans at amortized cost	₩ 347	18,675
Others:		
Loss on hedged items	518,891	605,808
Fund contribution	397,884	367,993
Provision for guarantees and acceptances	3,457	-
Provision for other debt allowances	52,123	16,862
Depreciation of operating lease assets	257,033	163,006
Others	1,190,546	924,796
	<u>2,419,934</u>	<u>2,078,465</u>
	₩ <u>2,420,281</u>	<u>2,097,140</u>
Net other operating expenses	₩ <u>(1,490,027)</u>	<u>(1,370,466)</u>

SHINHAN FINANCIAL GROUP CO., LTD. AND SUBSIDIARIES

Notes to the Consolidated Financial Statements

December 31, 2021 and 2020

(In millions of won)

40. Net other non-operating income

Other non-operating income and other non-operating expense for the years ended December 31, 2021 and 2020 are as follows:

	<u>December 31, 2021</u>	<u>December 31, 2020</u>
Other non-operating income		
Gain on disposal of assets:		
Property and equipment (*1)	₩ 1,836	64,427
Investment property (*1)	108	20,701
Assets held for sale	16,976	1,147
Lease assets	247	2,712
Right-of-use assets	2,986	3,415
Others	-	24
	<u>22,153</u>	<u>92,426</u>
Gain on disposal of Investments in associates	39,593	11,325
Others:		
Rental income on investment property	35,887	23,890
Reversal of impairment losses on intangible asset	372	119
Gain from assets contributed	20	4
Others	64,272	66,268
	<u>100,551</u>	<u>90,281</u>
	<u>162,297</u>	<u>194,032</u>
Other non-operating expense		
Loss on disposal of assets:		
Property and equipment (*1)	2,027	5,884
Investment property	2,111	-
Lease assets	-	5,538
Right-of-use assets	2,920	1,195
Others	1,186	64
	<u>8,244</u>	<u>12,681</u>
Loss on disposal of investments in associates	11,002	5,754
Impairment loss on investments in associates	10,719	9,407
	<u>21,721</u>	<u>15,161</u>
Others:		
Donations	64,098	86,608
Depreciation of investment properties	21,616	20,165
Impairment loss on property and equipment	7,594	-
Impairment loss on intangible assets	34,916	41,429
Write-off of intangible assets	1,346	474
Expenses on collection of special bonds	11,275	7,978
Others (*2)	518,519	344,934
	<u>659,364</u>	<u>501,588</u>
	<u>689,329</u>	<u>529,430</u>
Net other non-operating loss	₩ <u>(527,032)</u>	<u>(335,398)</u>

(*1) Gain and loss on disposal of sale-and-leaseback are included in gain and loss on disposal of property, plant, and equipment and gain on disposal of investment property, respectively. Gain on disposal of sale-and-leaseback for the year ended December 31, 2020 is ₩ 9,761 million.

(*2) It includes ₩ 466,775 million and ₩ 284,176 million, respectively, for the years ended December 31, 2021 of estimated claim for damages that are highly probable to be paid in case of customer losses expected due to redemption delays of Lime CI funds.

SHINHAN FINANCIAL GROUP CO., LTD. AND SUBSIDIARIES

Notes to the Consolidated Financial Statements

December 31, 2021 and 2020

(In millions of won)

41. Income tax expense

(a) Income tax expense for the years ended December 31, 2021 and 2020 are as follows:

	<u>December 31, 2021</u>	<u>December 31, 2020</u>
Current income tax expense	₩ 1,498,819	1,131,254
Temporary differences	(322,279)	131,862
Income tax recognized in other comprehensive income	294,496	(7,321)
Income tax expenses	<u>₩ 1,471,036</u>	<u>1,255,795</u>

(b) Income tax expense calculated by multiplying net income before tax with the tax rate for the years ended December 31, 2021 and 2020 are as follows:

	<u>December 31, 2021</u>	<u>December 31, 2020</u>
Profit before income taxes	₩ 5,583,664	4,753,871
Income taxes at statutory tax rates	1,530,030	1,301,836
Adjustments:		
Non-taxable income	(8,417)	(4,932)
Non-deductible expense	15,975	14,529
Tax credit	(159)	(88)
Others	(66,393)	(55,550)
Income tax expense	<u>₩ 1,471,036</u>	<u>1,255,795</u>
Effective tax rate	%	26.35
		26.42

SHINHAN FINANCIAL GROUP CO., LTD. AND SUBSIDIARIES

Notes to the Consolidated Financial Statements

December 31, 2021 and 2020

(In millions of won)

41. Income tax expense (continued)

(c) Deferred tax expenses by origination and reversal of deferred assets and liabilities and temporary differences for the years ended December 31, 2021 and 2020 are as follows:

	December 31, 2021			
	Beginning Balance	Profit or loss	Other comprehensive income(loss)	Ending Balance(*)
Unearned income	₩ (328,278)	(12,714)	-	(340,992)
Account receivable	(29,078)	2,498	-	(26,580)
Financial assets measured at fair value	(142,085)	83,716	325,327	266,958
Investment in associates and etc	161,270	22,616	(5,624)	178,262
Valuation and depreciation of property and equipment	(150,786)	14,616	-	(136,170)
Derivative asset (liability)	(55,590)	86,234	(8,995)	21,649
Deposits	27,632	(3,202)	-	24,430
Accrued expenses	140,864	13,852	-	154,716
Defined benefit obligation	538,654	26,411	(15,115)	549,950
Plan assets	(553,907)	(47,067)	(870)	(601,844)
Other provisions	312,278	77,268	-	389,546
Allowance for acceptances and guarantees	88,050	(55,588)	-	32,462
Allowance related to asset revaluation	(49,713)	-	-	(49,713)
Allowance for expensing depreciation	(337)	63	-	(274)
Accrued contributions	16,618	19,496	-	36,114
Financial assets(liabilities) designated at fair value through profit of loss	(28,226)	(46,429)	-	(74,655)
Allowances	223,651	(91,412)	-	132,239
Constructive dividend	16,291	446	-	16,737
Liability under insurance contracts	1,739	132	-	1,871
Deficit carried over	311	(311)	-	-
Others	(837,736)	(44,441)	(227)	(882,404)
	<u>(648,378)</u>	<u>46,184</u>	<u>294,496</u>	<u>(307,698)</u>
Expired unused tax losses:				
Extinguishment of deposit and insurance liabilities	284,067	(17,462)	-	266,605
	<u>₩ (364,311)</u>	<u>28,722</u>	<u>294,496</u>	<u>(41,093)</u>

(*) Deferred tax assets from overseas subsidiaries are increased by ₩ 939 million due to foreign exchange rate movements.

SHINHAN FINANCIAL GROUP CO., LTD. AND SUBSIDIARIES

Notes to the Consolidated Financial Statements

December 31, 2021 and 2020

(In millions of won)

41. Income tax expense (continued)

(c) Deferred tax expenses by origination and reversal of deferred assets and liabilities and temporary differences for the years ended December 31, 2021 and 2020 are as follows (continued) :

		December 31, 2020				
		Beginning Balance	Business combination	Profit or loss	Other comprehensive income(loss)	Ending Balance(*)
Unearned income	₩	(331,679)	-	3,401	-	(328,278)
Account receivable		(26,324)	-	(2,754)	-	(29,078)
Financial assets measured at fair value		(101,577)	1,750	(28,950)	(13,308)	(142,085)
Investment in associates and etc		18,758	-	144,390	(1,878)	161,270
Valuation and depreciation of property and equipment		(151,046)	7	253	-	(150,786)
Derivative asset (liability)		21,005	-	(80,357)	3,762	(55,590)
Deposits		30,641	-	(3,009)	-	27,632
Accrued expenses		145,494	441	(5,071)	-	140,864
Defined benefit obligation		506,132	209	39,072	(6,759)	538,654
Plan assets		(507,140)	-	(47,934)	1,167	(553,907)
Other provisions		213,055	-	99,223	-	312,278
Allowance for acceptances and guarantees		80,014	-	8,036	-	88,050
Allowance related to asset revaluation		(49,713)	-	-	-	(49,713)
Allowance for expensing depreciation		(401)	-	64	-	(337)
Deemed dividend		-	-	-	-	-
Accrued contributions		36,818	-	(20,200)	-	16,618
Financial assets(liabilities) designated at fair value through profit of loss		42,817	-	(71,043)	-	(28,226)
Allowances		38,068	-	185,583	-	223,651
Constructive dividend		1,341	-	14,950	-	16,291
Liability under insurance contracts		24,147	-	(22,408)	-	1,739
Deficit carried over		-	-	311	-	311
Others		(543,770)	451	(304,112)	9,695	(837,736)
		<u>(553,360)</u>	<u>2,858</u>	<u>(90,555)</u>	<u>(7,321)</u>	<u>(648,378)</u>
Expired unused tax losses:						
Extinction of deposit and insurance liabilities		320,011	-	(35,944)	-	284,067
	₩	<u>(233,349)</u>	<u>2,858</u>	<u>(126,499)</u>	<u>(7,321)</u>	<u>(364,311)</u>

(*) Deferred tax assets from overseas subsidiaries are increased by ₩ 1,960 million due to foreign exchange rate movements.

SHINHAN FINANCIAL GROUP CO., LTD. AND SUBSIDIARIES

Notes to the Consolidated Financial Statements

December 31, 2021 and 2020

(In millions of won)

41. Income tax expense (continued)

(d) Deferred tax assets and liabilities that are directly charged or credited to equity for the years ended December 31, 2021 and 2020 are as follows:

	January 1, 2021		Changes		December 31, 2021	
	OCI	Tax effect	OCI	Tax effect	OCI	Tax effect
Gain (loss) on valuation of financial assets measured at FVOCI	₩ 335,800	(108,989)	(1,160,013)	318,331	(824,213)	209,342
Gain (loss) on financial liabilities measured at FVTPL attributable to changes in credit risk	(7,133)	1,961	4,627	(1,272)	(2,506)	689
Foreign currency translation adjustments for foreign operations	(374,944)	(2,117)	258,068	(6,226)	(116,876)	(8,343)
Gain (loss) on cash flow hedge	(67,935)	19,764	29,931	(8,232)	(38,004)	11,532
Equity in other comprehensive income(loss) of associates	6,850	(2,000)	6,512	(3,766)	13,362	(5,766)
The accumulated other comprehensive income(loss) in separate account(*)	25,412	(6,988)	(56,484)	15,211	(31,072)	8,223
Remeasurements of the defined benefit liability	(532,176)	146,396	58,820	(16,164)	(473,356)	130,232
Gain (loss) on valuation of financial asset measured at FVTPL (Overlay approach)	224,049	(62,130)	(31,924)	11,826	192,125	(50,304)
	₩ <u>(390,077)</u>	<u>(14,103)</u>	<u>(890,463)</u>	<u>309,708</u>	<u>(1,280,540)</u>	<u>295,605</u>

	January 1, 2020		Changes		December 31, 2020	
	OCI	Tax effect	OCI	Tax effect	OCI	Tax effect
Gain (loss) on valuation of financial assets measured at FVOCI	₩ 439,370	(132,901)	(103,570)	23,912	335,800	(108,989)
Gain (loss) on financial liabilities measured at FVTPL attributable to changes in credit risk	(11,386)	3,131	4,253	(1,170)	(7,133)	1,961
Foreign currency translation adjustments for foreign operations	(208,348)	(9,117)	(166,596)	7,000	(374,944)	(2,117)
Gain (loss) on cash flow hedge	(47,977)	14,266	(19,958)	5,498	(67,935)	19,764
Equity in other comprehensive income(loss) of associates	8,300	(122)	(1,450)	(1,878)	6,850	(2,000)
The accumulated other comprehensive income(loss) in separate account(*)	20,054	(5,515)	5,358	(1,473)	25,412	(6,988)
Remeasurements of the defined benefit liability	(553,538)	152,006	21,362	(5,610)	(532,176)	146,396
Gain (loss) on valuation of financial asset measured at FVTPL (Overlay approach)	98,678	(27,057)	125,371	(35,073)	224,049	(62,130)
	₩ <u>(254,847)</u>	<u>(5,309)</u>	<u>(135,230)</u>	<u>(8,794)</u>	<u>(390,077)</u>	<u>(14,103)</u>

(*) Deferred tax effects, which are originated from the accumulated other comprehensive income in separate account, are included in the other liabilities of principle and interest guaranteed separate account's financial statement.

SHINHAN FINANCIAL GROUP CO., LTD. AND SUBSIDIARIES

Notes to the Consolidated Financial Statements

December 31, 2021 and 2020

(In millions of won)

41. Income tax expense (continued)

(e) There is no the amount of deductible temporary differences, that are not recognized as deferred tax assets as of December 31, 2021 and 2020.

(f) The amount of temporary difference regarding investment in subsidiaries that are not recognized as deferred tax liabilities as of December 31, 2021 and 2020 are as follows:

	<u>December 31, 2021</u>	<u>December 31, 2020</u>
Investment in associates	₩ (1,304,370)	(897,110)

(g) The Group set off a deferred tax asset against a deferred tax liability of the same taxable entity if, and only if, they relate to income taxes levied by the same taxation authority and the entity has a legally enforceable right to set off current tax assets against current tax liabilities. Deferred tax assets and liabilities presented on a gross basis prior to any offsetting as of December 31, 2021 and 2020 are as follows:

	<u>December 31, 2021</u>	<u>December 31, 2020</u>
Deferred tax assets	₩ 593,852	440,430
Deferred tax liabilities	(634,945)	(804,741)

SHINHAN FINANCIAL GROUP CO., LTD. AND SUBSIDIARIES

Notes to the Consolidated Financial Statements

December 31, 2021 and 2020

(In millions of won, except per share data)

42. Earnings per share

(a) Basic and diluted earnings per share for the years ended December 31, 2021 and 2020 are as follows:

	<u>December 31, 2021</u>	<u>December 31, 2020</u>
Profit attributable to equity holders of Shinhan Financial Group	₩ 4,019,254	3,414,595
Less:		
Dividends to hybrid bond	(116,388)	(85,327)
Net profit available for common stock	<u>₩ 3,902,866</u>	<u>3,329,268</u>
Weighted average number of common shares outstanding(*1)(*2)	534,049,948	500,343,324
Basic and diluted earnings per share in won	<u>₩ 7,308</u>	<u>6,654</u>

(*1) The number of basic ordinary shares outstanding is 516,599,554 shares and the above weighted-average stocks are calculated by reflecting treasury stocks issued and 17,482,000 shares of convertible preferred shares issued on May 1, 2019.

(*2) Treasury stock has retired on June 1, 2020.

(b) The calculation details of the weighted average number of ordinary shares for the years ended December 31, 2021 and 2020 are as follows:

	<u>December 31, 2021</u>	
	<u>Number of shares</u>	<u>Number of days</u>
Number of common shares issued	516,599,554	188,558,837,210
Shares of convertible preferred stock	17,482,000	6,380,930,000
Shares of treasury stock	(6,352)	(11,536,338)
Average number of ordinary shares	534,075,202	194,928,230,872
Days		365 days
Weighted average number of ordinary shares		534,049,948
	<u>December 31, 2020</u>	
	<u>Number of shares</u>	<u>Number of days</u>
Number of common shares issued	516,599,554	178,880,869,852
Shares of convertible preferred stock	17,482,000	6,398,412,000
Shares of treasury stock	(704,796)	(2,153,625,403)
Average number of ordinary shares	533,376,758	183,125,656,449
Days		366 days
Weighted average number of ordinary shares		500,343,324

SHINHAN FINANCIAL GROUP CO., LTD. AND SUBSIDIARIES

Notes to the Consolidated Financial Statements

December 31, 2021 and 2020

(In millions of won)

43. Commitments and contingencies

(a) Guarantees, acceptances and credit commitments as of December 31, 2021 and 2020 are as follows:

	<u>December 31, 2021</u>	<u>December 31, 2020</u>
Guarantees and purchase agreements:		
Outstanding guarantees	₩ 10,540,968	10,249,827
Contingent guarantees	4,670,771	3,433,953
ABS and ABCP purchase agreements	1,525,768	1,604,958
	<u>16,737,507</u>	<u>15,288,738</u>
Commitments to extend credit:		
Loan commitments in won	81,707,963	80,598,639
Loan commitments in foreign currency	19,807,686	19,319,903
Other agreements (*)	92,338,217	87,718,227
	<u>193,853,866</u>	<u>187,636,769</u>
Endorsed bills:		
Secured endorsed bills	8,199	1,650
Unsecured endorsed bills	7,683,165	7,324,559
	<u>7,691,364</u>	<u>7,326,209</u>
	<u>₩ 218,282,737</u>	<u>210,251,716</u>

(*) Unused credit commitments provided to the card customers are included, the amounts are ₩ 86,979,545 million for the year ended December 31, 2021 and ₩ 82,991,589 million for the year ended December 31, 2020.

SHINHAN FINANCIAL GROUP CO., LTD. AND SUBSIDIARIES

Notes to the Consolidated Financial Statements

December 31, 2021 and 2020

(In millions of won)

43. Commitments and contingencies (continued)

(b) Pending litigations

The Group's pending lawsuits as a defendant as of December 31, 2021 are as follows:

Case	Number of claim	Claim amount	Description	Status
Return of unjust earning	1	₩ 33,096	The Plaintiff believes that the group of lenders including the Group unfairly sold two oil drilling vessels that are the core assets for borrowers and it caused losses to other bankrupt creditors of the borrower. Therefore, the Plaintiff filed a lawsuit for damages.	The first order is ongoing as of December 31, 2021.
Request for return of trust and etc.	1	10,997	Claims for payment of principal of trust and trust profits upon termination of a specific trust. Loans lawsuit	It was filed on December 13, 2021 The Group won the first order and second order is ongoing as of December 31, 2021.
Loans lawsuit	1	10,654		The Group won the first order and second order is ongoing as of December 31, 2021.
Return of down payment for Ulsan Innovative City	1	12,045	The Plaintiffs, the distributors, had received the properties from the Group in accordance with the Act of Industrial Integration, but Ulsan City refused to approve the move-in under the Act of Innovative City, claiming that if the Act of Innovative City is applied, they will suffer from significant losses in future re-transfer.	The Group won the first order and second order is ongoing as of December 31, 2021.
Others(*)	583	337,417	It includes various cases, such as compensation for loss claim.	
	<u>587</u>	<u>₩ 404,209</u>		

(*) In January 2022, two lawsuits were filed, claiming damages (lawsuit value of ₩101,183 million) for joint and several liability.

As of the December 31, 2021, the Group has recorded ₩9,693 million and ₩3,828 million, respectively, as provisions and insurance contract liabilities (reserve for claims) for litigations, etc., which have been decided to lose at the first trial. The outcome of the remaining litigations other than those accounted for provisions, etc. are not expected to have a material impact on the consolidated financial statements, but additional losses may result from future litigation.

(c) The Group entered into an agreement between shareholders with Asia Trust Co., Ltd. (60% of its total shares) to acquire remaining stake. In accordance with the agreement, the Group has the right to purchase shares held by the shareholders of Asia Trust Co., Ltd. In response, the shareholders of Asia Trust Co., Ltd. have the right to demand to purchase the shares to the Group.

SHINHAN FINANCIAL GROUP CO., LTD. AND SUBSIDIARIES

Notes to the Consolidated Financial Statements

December 31, 2021 and 2020

(In millions of won)

43. Commitments and contingencies (continued)

(d) As a Prime Brokerage Service operator, the Group entered into a total return swap agreement (TRS, derivatives that exchange profits and losses from underlying assets such as stocks, bonds and funds) with a fund operated by Lime Asset Management ("Lime Fund"). Through TRS with the Group, the Lime Fund invested approximately \$200 million in IIG Global Trade Finance Fund, IIG Trade Finance Fund, and IIG Trade Finance Fund-FX Hedged ("IIG Fund") from May 2017 to September 2017. The Group invested the IIG Fund in LAM Enhanced Finance III L.P. ("LAM III Fund") in kind and acquired the LAM III Fund's beneficiary certificates in accordance with the management instructions of Lime Asset Management in 2019. The recoverable value of the LAM III Fund beneficiary certificates is affected by the recoverable value of the IIG Fund invested in kind.

Meanwhile, IIG Fund received cancellation of registration and asset freeze from the US Securities and Exchange Commission in November 2019. The Financial Supervisory Service (FSS) announced in its interim inspection of Lime Fund in February 2020 that the Group is charged of being involved in poor concealment and fraud of Lime Fund while operating TRSs with Lime Fund, and a related prosecution investigation has been under way since then.

Institutional sanctions (Shinhan Investment Corp. has been banned from the sale of new private equity funds and etc for six months) against the Group was finalized by the Financial Services Commission on November 12, 2021.

In addition, the prosecution arrested and indicted the former director of Prime Brokerage Services for fraud charges and violation of the Capital Market and Financial Investment Services Act. Finally, the former director of Prime Brokerage Services was found guilty.

The prosecution indicted the Group and the former director of Prime Brokerage Services on January 22, 2021 for violating 'Financial Investment Services and Capital Markets Act'. It is expected that the criminal trial will determine whether the Group is legally responsible or not. The Group has determined the present obligation that the Group may liable for the charge of involvement in the fraud is not significant.

As of December 31, 2021, there is a dispute between companies over some beneficiary certificates acquired under the management order of Lime Asset Management.

Considering the board resolutions and the results of the Financial Supervisory Service's dispute settlement committee, the Group has been completed or will be carried out the compensation and liquidity supply for some of the Lime Fund sales in the future.

(e) The Group sold approximately ₩390.7 billion of German Heritage DLS trust products from May 2017 to December 2018. As of December 31, 2021, the repayment of ₩379.9 billion has been delayed. Accordingly, the supervisory authorities were conducting an inspection on the incomplete sale of trust products. The institutional sanctions (Shinhan Investment Corp. has been banned from the sale of new private equity funds and etc for six months) against the Group was partially finalized by the Financial Services Commission on November 12, 2021.

(f) The Group has sold Gen2 related trust instruments from May 2014 to November 2019. As of December 31, 2021, approximately ₩373.8 billion, expired amount, of ₩420.0 billion, outstanding balance, is suspended from redemption and delayed in repayment. In accordance with a resolution of the Board of Directors on September 28, 2021, the Group has decided to pay 40% of the investment principal to the customers who have agreed to the suspension of redemption and settle the amount upon investment recovery.

SHINHAN FINANCIAL GROUP CO., LTD. AND SUBSIDIARIES

Notes to the Consolidated Financial Statements

December 31, 2021 and 2020

(In millions of won)

43. Commitments and contingencies (continued)

(g) The Group is responsible for the completion of construction when the contractor fails to fulfill its responsibilities. In case the Group fails to fulfill its responsibility, it is in the process of a responsible-for-completion land trust project (122 cases other than the new construction project of accommodation facilities in Sutaek-dong, Guri-si, Gyeonggi-do (excluding completed workplaces)) to compensate for damages incurred to the financial institutions, and for the year ended December 31, 2021, the total PF loans amounted to ₩4,344.9 billion. The amount of claim for damages of the Group is determined after identifying whether it is a damage caused by the Group's failure to fulfill its responsibilities. As of December 31, 2021, the risk of the Group to bear the responsibility to complete the project is low, and the loss cannot be reliably measured, hence this was not reflected in the financial statements for the year ended December 31, 2021. Meanwhile, the process of each business sites will be continuously monitored.

SHINHAN FINANCIAL GROUP CO., LTD. AND SUBSIDIARIES

Notes to the Consolidated Financial Statements

December 31, 2021 and 2020

(In millions of won)

44. Statement of cash flows

(a) Cash and cash equivalents in the consolidated statements of cash flows as of December 31, 2021 and 2020 are as follows:

	<u>December 31, 2021</u>	<u>December 31, 2020</u>
Cash and due from banks at amortized cost	₩ 28,471,127	33,420,549
Adjustments:		
Due from financial institutions with a maturity over three months from date of acquisition	(1,490,600)	(2,488,156)
Restricted due from banks	(13,896,642)	(21,969,411)
	<u>(15,387,242)</u>	<u>(24,457,567)</u>
	₩ <u>13,083,885</u>	<u>8,962,982</u>

(b) Significant non-cash activities for the years ended December 31, 2021 and 2020 are as follows:

	<u>December 31, 2021</u>	<u>December 31, 2020</u>
Investment conversion	₩ 32,239	58,528
Transfers from construction-in-progress to property and equipment	18,748	56,575
Transfers between property and equipment and investment property	73,773	4,064
Transfers between assets held for sale and property and equipment	1,022	31,633
Transfers between investment property and assets held for sale	2,238	910
Accounts payable for purchase of intangible assets, etc.	137,058	137,476
Transaction for right-of-use assets	289,995	281,785
Exchange of shares related to acquisition of subsidiaries	-	629,449
Exchange of shares related to disposal of treasury stocks	-	287,669

SHINHAN FINANCIAL GROUP CO., LTD. AND SUBSIDIARIES

Notes to the Consolidated Financial Statements

December 31, 2021 and 2020

(In millions of won)

44. Statement of cash flows (continued)

(c) Changes in assets and liabilities arising from financing activities for the years ended December 31, 2021 and 2020 are as follows:

	December 31, 2021				
	Net Derivative liabilities	Borrowings	Debt securities issued	Lease liabilities	Total
Beginning balance	₩ (88,784)	41,594,064	75,134,394	594,161	117,233,835
Changes from cash flows	12,667	849,212	4,417,830	(275,273)	5,004,436
Changes from non-cash flows					
Amortization of discount on borrowings and debentures	-	(71,390)	9,257	10,873	(51,260)
Changes in foreign currency	-	193,892	779,919	-	973,811
Other non-financial change	(5,290)	601,287	(192,037)	282,929	686,889
Ending balance	₩ (81,407)	43,167,065	80,149,363	612,690	123,847,711
	December 31, 2020				
	Net Derivative liabilities	Borrowings	Debt securities issued	Lease liabilities	Total
Beginning balance	₩ (5,822)	34,863,156	75,363,364	1,104,259	111,324,957
Changes from cash flows	43,676	7,465,106	(28,372)	(781,867)	6,698,543
Changes from non-cash flows					
Amortization of discount on borrowings and debentures	-	22,836	437,627	14,504	474,967
Changes in foreign currency	-	271,179	(417,151)	-	(145,972)
Other non-financial change	(126,638)	(1,037,213)	(221,074)	256,426	(1,128,499)
Business combination(Note47)	-	9,000	-	839	9,839
Ending balance	₩ (88,784)	41,594,064	75,134,394	594,161	117,233,835

SHINHAN FINANCIAL GROUP CO., LTD. AND SUBSIDIARIES

Notes to the Consolidated Financial Statements

December 31, 2021 and 2020

(In millions of won)

45. Related parties

Intra-group balances, and income and expenses arising from intra-group transactions are eliminated in preparing the consolidated financial statements. In accordance with K-IFRS No. 1024, the Group defines the retirement benefit plans of the associates, key management and their families, the consolidation group and related parties as the scope of related parties. The amount of profit and loss, bond and debt balance between the Group and the related parties are disclosed. For details of the subsidiaries and associates, refer to 'Note 15'.

(a) Balances with the related parties as of December 31, 2021 and 2020 are as follows:

Related party	Account	December 31, 2021	December 31, 2020
Investments in associates:			
BNP Paribas Cardif Life Insurance	Other assets	₩ 61	76
"	Credit card loans	87	81
"	Deposits	14,870	13,941
Partners 4th Growth Investment Fund	Deposits	10,096	2,802
BNP Paribas Cardif General Insurance	Credit card loans	24	21
"	ACL	(2)	-
"	Other provisions	4	-
"	Deposits	1,455	41
Dream High Fund III	Deposits	4	4
Credian Healthcare Private Equity Fund II(*)	Deposits	-	2
Midas Dong-A Snowball Venture Fund 2	Deposits	350	1,739
Eum Private Equity Fund No.3(*)	Deposits	-	20
Incorporated association Finance Saving Information Center	Deposits	16	7
Nomura investment property trust No.19	Loans	11,880	11,976
"	Other assets	-	44
SH MAIN Professional Investment Type Private Mixed Asset Investment Trust No.3	Other assets	345	1,160
Korea Finance Security	Deposits	457	568
SHINHAN-CORE TREND GLOBAL FUND 1	Unearned revenue	17	16
Hermes Private Investment Equity Fund	Deposits	246	352
Korea Credit Bureau	Deposits	1,394	2,088
Goduck Gangil1 PFV Co., Ltd	Loans	12,000	24,000
"	ACL	(52)	(71)
SBC PFV Co., Ltd	Deposits	33,278	8,011
Sprott Global Renewable Private Equity Fund I	Deposits	176	258
IMM Global Private Equity Fund	Loans	800	800
"	ACL	(3)	(2)
"	Deposits	21,543	10,820
Goduck Gangil10 PFV Co., Ltd	Loans	7,600	9,400
"	ACL	(24)	(19)
"	Deposits	72,740	2,718
Shinhan Global Healthcare Fund 2	Deposits	1	1
One Shinhan Global Fund 1	Unearned revenue	104	122
IGIS PRIVATE REAL ESTATE TRUST NO.331(*)	Loans	-	9,919
"	Accrued income	-	121
"	Unearned revenue	-	22

SHINHAN FINANCIAL GROUP CO., LTD. AND SUBSIDIARIES

Notes to the Consolidated Financial Statements

December 31, 2021 and 2020

(In millions of won)

45. Related parties (continued)

(a) Balances with the related parties as of December 31, 2021 and 2020 are as follows (continued):

Related party	Account	December 31, 2021	December 31, 2020
Investments in associates (continued):			
COSPEC BIM tech(*)	Loans	₩ -	151
"	ACL	-	(95)
"	Deposits	-	1
IMM Special Situation 1-2 PRIVATE EQUITY FUND	Deposits	23	117
EDNCENTRAL Co.,Ltd.	Loans	19,739	19,450
"	Accrued income	9	9
"	Deposits	1	-
"	Unearned revenue	40	578
KoFC-Neoplux R&D-Biz Creation 2013-1 Investment(*)	Account receivables	-	2,823
Future-Creation Neoplux Venture Capital Fund	Account receivables	3,919	4,137
Neoplux Market-Frontier Secondary Fund	Account receivables	954	1,630
Gyeonggi-Neoplux Superman Fund	Account receivables	620	186
Shinhan-Neoplux Energy Newbiz Fund	Account receivables	1,002	25
SHINHAN-NEO Core Industrial Technology Fund	Account receivables	-	3
KTC-NP Growth Champ 2011-2 Private Equity Fund	Account receivables	4,512	4,528
Neoplux No.3 Private Equity Fund	Account receivables	662	748
NV Station Private Equity Fund	Deposits	41	100
Pacific Sunny Professional Investors Private Placement Real Estate Investment Company No.45	Unearned revenue	-	76
IGIS Private Real Estate Investment Trust 286(*)	Other loans	-	436
Genesis North America Power Company No.1 PEF	Other loans	-	2,171
Korea Digital Asset Custody	Deposits	526	-
SW-N Fund	Deposits	115	-
Shinhan Smilegate Global PEF I	Unearned revenue	49	-
WaveTechnology co.Ltd	Deposits	99	-
SHINHAN-NEO Market-Frontier 2nd Fund	Account receivables	513	-
iPIXEL Co.,Ltd.	Loans	55	-
"	Deposits	651	-
CJL No.1 Private Equity Fund	Deposits	779	-
Nova New Technology Investment Fund No.1	Deposits	357	-
Key management personnel and their immediate relatives:			
	Loans	6,149	5,144
	Assets	70,850	98,852
	Liabilities	₩ 159,432	44,404

(*) Excluded from the associates due to disposal and liquidation for the year ended December 31, 2021

SHINHAN FINANCIAL GROUP CO., LTD. AND SUBSIDIARIES

Notes to the Consolidated Financial Statements

December 31, 2021 and 2020

(In millions of won)

45. Related parties (continued)

(b) Transactions with the related parties for the years ended December 31, 2021 and 2020 are as follows:

Related party	Account	December 31, 2021	December 31, 2020
Investments in associates			
BNP Paribas Cardif Life Insurance	Fees and commission income	₩ 3,023	3,390
"	Interest expense	(13)	(5)
"	General and administrative expenses	(2)	(4)
Shinhan Praxis K-Growth Global Private Equity Fund	Fees and commission income	323	361
BNP Paribas Cardif General Insurance	Fees and commission income	10	10
"	Reversal for credit loss	6	-
"	Other operating income	-	333
"	Interest expense	(1)	-
SM New Technology Business Investment Fund I(*1)	Fees and commission income	187	-
Partners 4th Growth Investment Fund	Interest expense	(11)	(4)
Shinhan-Albatross Technology Investment Fund	Fees and commission income	129	54
KDBC Midas Dong-A Snowball Venture Fund No.2	Interest expense	-	(2)
SHC-K2 Global Material Fund(*2)	Fees and commission income	-	19
Synergy-Shinhan Mezzanine New Technology Investment Fund(*2)	Fees and commission income	-	50
Shinhan-Midas Dong-A Secondary Venture Fund	Fees and commission income	115	63
GX Shinhan interest 1st Private Equity Fund(*2)	Fees and commission income	-	454
Shinhan-Nvestor Liquidity Solution Fund	Fees and commission income	271	361
SHC ULMUS Fund No.1(*2)	Fees and commission income	-	39
Shinhan-PS Investment Fund No.1	Fees and commission income	20	20
Nomura investment property trust No.19	Interest income	530	525
"	Other operating income	-	3
SH MAIN Professional Investment Type Private Mixed Asset Investment Trust No.3	Fees and commission income	974	2,501

SHINHAN FINANCIAL GROUP CO., LTD. AND SUBSIDIARIES

Notes to the Consolidated Financial Statements

December 31, 2021 and 2020

(In millions of won)

45. Related parties (continued)

(b) Transactions with the related parties for the years ended December 31, 2021 and 2020 are as follows:

Related party	Account	December 31, 2021	December 31, 2020
Investments in associates (continued)			
KOREA FINANCE SECURITY	Fees and commission income	₩ 8	10
"	Interest expense	(1)	(1)
ShinHan – Soo Young Entrepreneur Investment Fund	Fees and commission income	1,028	206
Shinhan-Rhinos 1 Fund	Fees and commission income	47	64
SHINHAN-CORE TREND GLOBAL FUND1	Fees and commission income	106	100
Kiwoom-Shinhan Innovation Fund I	Fees and commission income	240	240
One Shinhan Global Fund1	Fees and commission income	208	399
Open-Shinhan Portfolio Investment Association No. 1	Fees and commission income	59	59
FuturePlay-Shinhan TechInnovation Fund 1	Fees and commission income	241	218
Korea Credit Bureau	Fees and commission income	14	13
"	Interest expense	(9)	(12)
Goduck Gangil1 PFV Co., Ltd	Interest income	754	915
"	Reversal for credit loss	20	7
SBC PFV Co., Ltd	Fees and commission income	776	732
"	Interest expense	(14)	(5)
IMM Global Private Equity Fund	Interest income	23	25
"	Interest expense	(49)	(13)
"	Provision for credit loss	(1)	-
Goduck Gangil10 PFV Co., Ltd	Interest income	283	299
"	Fees and commission income	-	793
"	Interest expense	(78)	(4)
"	Provision for credit loss	(4)	(19)
IGIS PRIVATE REAL ESTATE TRUST NO.331(*1)	Interest income	-	731
"	Other operating expense	-	(67)
"	Fees and commission income	-	478
COSPEC BIM tech(*1)	Interest income	41	-
"	Provision(reversal) for credit loss	95	(95)
Korea Omega Project Fund I	Fees and commission income	180	131
New Green Shinhan Mezzanine Fund(*1)	Fees and commission income	334	42

SHINHAN FINANCIAL GROUP CO., LTD. AND SUBSIDIARIES

Notes to the Consolidated Financial Statements

December 31, 2021 and 2020

(In millions of won)

45. Related parties (continued)

(b) Transactions with the related parties for the years ended December 31, 2021 and 2020 are as follows:

Related party	Account	December 31, 2021	December 31, 2020
Investments in associates (continued)			
Sparklabs-Shinhan Opportunity Fund 1	Fees and commission income	₩ 202	174
EDNCENTRAL Co.,Ltd.	Interest income	1,140	649
"	Fees and commission income	714	578
"	Other operating expense	-	(121)
Shinhan Western T&D Consignment Management Real Estate Investment Co., Ltd(*2)	Fees and commission income	-	300
Kakao-Shinhan 1st TNYT Fund	Fees and commission income	386	165
KoFC-Neoplux R&D-Biz Creation 2013-1 Investment(*1)	Interest income	1	9
"	Fees and commission income	5,474	44
Future-Creation Neoplux Venture Capital Fund	Interest income	31	14
"	Fees and commission income	308	116
Neoplux Market-Frontier Secondary Fund	Fees and commission income	954	416
Gyeonggi-Neoplux Superman Fund	Fees and commission income	621	149
Shinhan-Neoplux Energy Newbiz Fund	Fees and commission income	1,002	308
NewWave 6th Fund	Fees and commission income	1,210	303
SHINHAN-NEO Core Industrial Technology Fund	Fees and commission income	498	3
KTC-NP Growth Champ 2011-2 Private Equity Fund	Interest income	26	5
"	Fees and commission income	-	86
Neoplux No.3 Private Equity Fund	Fees and commission income	2,433	748
Pacific Sunny Professional Investors Private Placement Real Estate Investment Company No.45	Fees and commission income	83	1,412
CREDIAN T&F 2020 CORPORATE FINANCIAL STABILITY PRIVATE EQUITY FUND(*2)	Interest expense	-	(1)

SHINHAN FINANCIAL GROUP CO., LTD. AND SUBSIDIARIES

Notes to the Consolidated Financial Statements

December 31, 2021 and 2020

(In millions of won)

45. Related parties (continued)

(b) Transactions with the related parties for the years ended December 31, 2021 and 2020 are as follows:

Related party	Account	December 31, 2021	December 31, 2020
Investments in associates (continued)			
Shinhan Smilegate Global PEF I	Fees and commission income	₩ 189	-
SHINHAN-NEO Market-Frontier 2nd Fund	Fees and commission income	2,026	-
Korea Digital Asset Custody	Interest expense	(2)	-
SWK-Shinhan New Technology Investment Fund 1st	Fees and commission income	41	-
Ulmus SHC innovation investment fund	Fees and commission income	63	-
iPIXEL Co.,Ltd.	Interest income	2	-
CJL No.1 Private Equity Fund	Interest expense	(2)	-
Reverent-Shinhan Vista Fund	Fees and commission income	90	-
Hermes Private Investment Equity Fund	Interest expense	(1)	-
Kiwoom-Shinhan Innovation Fund 2	Fees and commission income	115	-
ETRI Holdings-Shinhan 1st Unicorn Fund	Fees and commission income	32	-
Shinhan-Time mezzanine blind Fund	Fees and commission income	300	-
Shinhan VC tomorrow venture fund 1	Fees and commission income	419	-
JS Shinhan Private Equity Fund	Fees and commission income	250	-
Key management personnel and their immediate relatives			
Interest income		122	126
		₩ 28,589	18,897

(*1) Excluded from the associates due to disposal and liquidation for the year ended December 31, 2021

(*2) Excluded from the associates due to disposal and liquidation for the year ended December 31, 2020.

SHINHAN FINANCIAL GROUP CO., LTD. AND SUBSIDIARIES

Notes to the Consolidated Financial Statements

December 31, 2021 and 2020

(In millions of won)

45. Related parties (continued)

(c) Key management personnel compensation

Key management personnel compensation for the years ended December 31, 2021 and 2020 are as follows:

	December 31, 2021	December 31, 2020
Short-term employee benefits	₩ 23,972	23,468
Severance benefits	686	651
Share-based payment transactions(*)	13,886	2,628
	<u>₩ 38,544</u>	<u>26,747</u>

(*) The expenses of share-based payment transactions are the remuneration expenses during the vesting period.

(d) The guarantees provided between the related parties as of December 31, 2021 and 2020 are as follows:

Guarantor	Guaranteed Parties	Amount of guarantees		Account
		December 31, 2021	December 31, 2020	
Shinhan Bank	BNP Paribas Cardif Life Insurance	₩ 10,000	10,000	Unused loan limit
Shinhan Card	BNP Paribas Cardif Life Insurance	913	919	Unused credit line
"	BNP Paribas Cardif General Insurance	226	229	Unused credit line
The Group	Structured entities	207,078	135,459	Purchase agreement
		<u>₩ 218,217</u>	<u>146,607</u>	

(e) Details of collaterals provided by the related parties as of December 31, 2021 and 2020 are as follows:

Provided to	Provided by	Pledged assets	Amount of assets pledged	
			December 31, 2021	December 31, 2020
Shinhan Bank	BNP Paribas Cardif Life Insurance	Government bonds	₩ 12,000	12,000
	Hyungje art printing	Properties	-	120
	Goduck Gangil1 PFV Co., Ltd	Guarantee insurance policy	-	28,800
	Goduck Gangil10 PFV Co., Ltd	Guarantee insurance policy	-	13,000
	iPIXEL Co.,Ltd.	Electronic credit guarantee	190	-
			<u>₩ 12,190</u>	<u>53,920</u>

SHINHAN FINANCIAL GROUP CO., LTD. AND SUBSIDIARIES

Notes to the Consolidated Financial Statements

December 31, 2021 and 2020

(In millions of won)

45. Related parties (continued)

(f) Details of significant loan transactions with related parties as of December 31, 2021 and 2020 are as follows:

Classification	Company	December 31, 2021				
		Beginning	Execution	Collection	Others(*)	Ending
Investments in associates	Nomura investment property trust No.19 IGIS PRIVATE REAL ESTATE TRUST NO.331	₩ 11,973	-	-	(93)	11,880
	EDNCENTRAL Co.,Ltd.	9,688	-	(9,769)	81	-
	Goduck Gangil1 PFV Co., Ltd.	19,381	-	-	358	19,739
	Goduck Gangil10 PFV Co., Ltd.	24,000	-	(12,000)	-	12,000
	IMM Global Private Equity Fund	9,400	600	(2,400)	-	7,600
	COSPEC BIM tech	800	-	-	-	800
	iPIXEL Co.,Ltd.	151	-	-	(151)	-
		-	71	-	(16)	55
	Total	₩ 75,393	671	(24,169)	179	52,074

(*) The effect on changes in allowance for credit loss is included.

Classification	Company	December 31, 2020				
		Beginning	Loan	Recover	Others(*1)	Ending
Investments in associates	Nomura investment property trust No.19 IGIS PRIVATE REAL ESTATE TRUST NO.331	₩ 11,973	-	-	-	11,973
	EDNCENTRAL Co.,Ltd.	-	10,000	-	(312)	9,688
	Goduck Gangil1 PFV Co., Ltd	-	20,000	-	(619)	19,381
	Goduck Gangil10 PFV Co., Ltd	24,000	-	-	-	24,000
	IMM Global Private Equity Fund	-	28,200	(18,800)	-	9,400
	COSPEC BIM tech(*2)	800	-	-	-	800
		-	-	-	151	151
	Total	₩ 36,773	58,200	(18,800)	(780)	75,393

(*1) The effect on changes in allowance for credit loss is included.

(*2) For the year ended December 31, 2020, it is incorporated as a related party, and has marked the balance as of December 31, 2020.

SHINHAN FINANCIAL GROUP CO., LTD. AND SUBSIDIARIES

Notes to the Consolidated Financial Statements

December 31, 2021 and 2020

(In millions of won)

46. Interests in unconsolidated structured entities

(a) The nature and extent of interests in unconsolidated structured entities

The Group involved in assets-backed securitization, structured financing, beneficiary certificates (primarily investment funds) and other structured entities and characteristics of these structured entities are as follows:

	<u>Description</u>
Assets-backed securitization	<p>Securitization vehicles are established to buy assets from originators and issue asset-backed securities in order to facilitate the originators' funding activities and enhance their financial soundness. The Group is involved in the securitization vehicles by purchasing (or committing to purchase) the asset-backed securities issued and/or providing other forms of credit enhancement.</p> <p>The Group does not consolidate a securitization vehicle if (i) the Group is unable to make or approve decisions as to the modification of the terms and conditions of the securities issued by such vehicle or disposal of such vehicles' assets, (ii) (even if the Group is so able) if the Group does not have the exclusive or primary power to do so, or (iii) if the Group does not have exposure, or right, to a significant amount of variable returns from such entity due to the purchase (or commitment to purchase) of asset-backed securities so issued or subordinated obligations or by providing other forms of credit support.</p>
Structured financing	<p>Structured entities for project financing are established to raise funds and invest in a specific project such as M&A (mergers and acquisitions), BTL (build-transfer-lease), shipping finance, etc. The Group is involved in the structured entities by originating loans, investing in equity, or providing credit enhancement.</p>
Investment fund	<p>Investment fund means an investment trust, a PEF (private equity fund) or a partnership which invests in a group of assets such as stocks or bonds by issuing a type of beneficiary certificates to raise funds from the general public, and distributes its income and capital gains to their investors. The Group manages assets by investing in shares of investment fund or playing a role of an operator or a GP (general partner) of investment fund, on behalf of other investors.</p>

The size of unconsolidated structured entities as of December 31, 2021 and 2020 are as follows:

	<u>December 31, 2021</u>	<u>December 31, 2020</u>
Total assets:		
Asset-backed securitization	₩ 248,200,446	253,958,036
Structured financing	255,854,384	257,475,395
Investment fund	301,241,508	203,863,889
	<u>₩ 805,296,338</u>	<u>715,297,320</u>

SHINHAN FINANCIAL GROUP CO., LTD. AND SUBSIDIARIES

Notes to the Consolidated Financial Statements

December 31, 2021 and 2020

(In millions of won)

46. Interests in unconsolidated structured entities (continued)

(b) Nature of risks

i) The carrying values of the assets and liabilities relating to its interests in unconsolidated structured entities as of December 31, 2021 and 2020 are as follows:

					December 31, 2021				
					Assets-backed securitization	Structured financing	Investment fund	Total	
Assets under consolidated financial statements:									
Loans measured at fair value through profit or loss	₩	16,352	156,630	42,231			215,213		
Loan at amortized cost		731,184	13,548,490	155,572			14,435,246		
Securities at fair value through profit or loss		3,752,394	235,238	14,014,493			18,002,125		
Derivate assets		4,343	16,560	-			20,903		
Securities at fair value through other comprehensive income		2,510,057	215,237	-			2,725,294		
Securities at amortized cost		6,493,106	-	-			6,493,106		
Other assets		138	17,280	177			17,595		
	₩	<u>13,507,574</u>	<u>14,189,435</u>	<u>14,212,473</u>			<u>41,909,482</u>		
Liabilities under consolidated financial statements:									
Derivate liabilities	₩	3,817	48	-			3,865		
Other liabilities		103	21,683	-			21,786		
	₩	<u>3,920</u>	<u>21,731</u>	<u>-</u>			<u>25,651</u>		
					December 31, 2020				
					Assets-backed securitization	Structured financing	Investment fund	Total	
Assets under consolidated financial statements:									
Loans measured at fair value through profit or loss	₩	10,007	396,006	-			406,013		
Loan at amortized cost		882,708	11,631,322	80,166			12,594,196		
Securities at fair value through profit or loss		4,703,527	200,966	9,403,611			14,308,104		
Derivate assets		10,353	1,050	-			11,403		
Securities at fair value through other comprehensive income		2,105,239	122,664	-			2,227,903		
Securities at amortized cost		6,294,228	-	-			6,294,228		
Other assets		2,019	59,980	4,936			66,935		
	₩	<u>14,008,081</u>	<u>12,411,988</u>	<u>9,488,713</u>			<u>35,908,782</u>		
Liabilities under consolidated financial statements:									
Derivate liabilities	₩	582	-	-			582		
Other liabilities		2,610	21,421	-			24,031		
	₩	<u>3,192</u>	<u>21,421</u>	<u>-</u>			<u>24,613</u>		

SHINHAN FINANCIAL GROUP CO., LTD. AND SUBSIDIARIES

Notes to the Consolidated Financial Statements

December 31, 2021 and 2020

(In millions of won)

46. Interests in unconsolidated structured entities (continued)

(b) Nature of risks (continued)

ii) *The maximum risk exposure of the Group relating to its interests in unconsolidated structured entities as of December 31, 2021 and 2020 are as follows:*

December 31, 2021				
	Assets-backed securitization	Structured financing	Investment fund	Total
Assets held	₩ 13,507,574	14,189,435	14,212,473	41,909,482
ABS and ABCP				
purchase agreements	895,273	2,210	2,703,353	3,600,836
Loan commitments	439,843	984,082	6,900	1,430,825
Guarantees	21,200	105,550	-	126,750
Others	-	150,579	-	150,579
	<u>₩ 14,863,890</u>	<u>15,431,856</u>	<u>16,922,726</u>	<u>47,218,472</u>
December 31, 2020				
	Assets-backed securitization	Structured financing	Investment fund	Total
Assets held	₩ 14,008,081	12,411,988	9,488,713	35,908,782
ABS and ABCP				
purchase agreements	932,113	2,300	1,923,035	2,857,448
Loan commitments	618,030	707,860	-	1,325,890
Guarantees	87,293	-	-	87,293
Others	-	123,210	5,887	129,097
	<u>₩ 15,645,517</u>	<u>13,245,358</u>	<u>11,417,635</u>	<u>40,308,510</u>

SHINHAN FINANCIAL GROUP CO., LTD. AND SUBSIDIARIES

Notes to the Consolidated Financial Statements

December 31, 2021 and 2020

(In millions of won)

47. Business combination

(a) Shinhan Venture Investment Co., Ltd.

i) General information

As of September 29, 2020, the Group gained control of Neoplux Co., Ltd. as a subsidiary by acquiring a 96.77% (97.08% stake of voting rights) stake and reporting to the Financial Services Commission about the transfer of subsidiary. As of December 30, 2020, the Group acquired the remaining shares, and Neoplux Co., Ltd. became a wholly owned subsidiary of the Group. Also, the name was changed from Neoplux Co., Ltd. to Shinhan Venture Investment Co., Ltd. The main reason for business combination is to promote investment financing and secure new business opportunities in the investment banking sector.

ii) Identifiable net assets

Fair values of assets acquired and liabilities assumed as of acquisition date are as follows:

	<u>Amount(*1)</u>
Assets:	
Cash and due from banks at amortized cost	₩ 179
Investment assets in the long-term	463
Venture capital investment assets	38,800
Private equity investment company investment assets	12,230
Property and equipment	835
Intangible assets(*2)	1,254
Other assets(*3)	18,911
	<u>72,672</u>
Liabilities:	
Borrowings	9,000
Other liabilities	4,804
	<u>13,804</u>
Fair value of the identifiable net assets	₩ <u>58,868</u>

(*1) The accounting for the acquisition of Shinhan Venture Investment Co., Ltd. was determined using the identifiable assets and liabilities recognized by Shinhan Venture Investment Co., Ltd. at the time of business combination.

(*2) The contract balance recognized as a business combination includes ₩ 793 million. The contract balance that Shinhan Venture Investment Co., Ltd. had was considered an important asset that can generate additional revenue in the future. Therefore, it was assessed at fair value through the Multi-period Excess Earning Method.

(*3) During the business combination, the Group acquired receivables that were fair value of ₩ 15,803 million, and the total contract amount was ₩ 15,803 million. There is no contractual cash flow that is not expected to be recovered from the receivables.

SHINHAN FINANCIAL GROUP CO., LTD. AND SUBSIDIARIES

Notes to the Consolidated Financial Statements

December 31, 2021 and 2020

(In millions of won)

47. Business combination (continued)

(a) Shinhan Venture Investment Co., Ltd. (continued)

iii) Goodwill

Goodwill recognized as a result of business combination is as follows:

	<u>Amount</u>
Consideration paid in cash	₩ 71,128
Fair value of identifiable net assets	(58,868)
Non-controlling interests(*)	<u>1,718</u>
Goodwill	<u>₩ 13,978</u>

(*) For the year ended December 31, 2020, the non-controlling interests for Shinhan Venture Investment Co., Ltd. were measured at proportionate shares of non-controlling interests in the acquiree's identifiable net assets for Shinhan Venture Investment Co., Ltd. At the business combination, the goodwill is generated because the transfer price includes the premium of corporate control paid to acquire Shinhan Venture Investment Co., Ltd. The transfer price for the business combination includes expected synergies, future market growth, and the amount related to human resources. These benefits are not recognized separately from goodwill because it does not meet the recognition requirements for identifiable intangible assets.

(b) Business Acquisition of Leaders Financial Sales Co., Ltd.

According to the resolutions of the Board of Directors on November 25, 2020 and December 23, 2020, The Group has acquired its GF and IMGA business department of Leaders Financial Sales Co., Ltd on May 31, 2021. The acquired assets and liabilities were recognized as fair value at the time of acquisition, and the difference between the fair value and the amount paid in consideration for the transfer was recognized as goodwill.

	<u>Amount</u>
Consideration paid in cash	₩
Cash	8,183
Contingent consideration arrangement	<u>2,600</u>
	<u>10,783</u>
Fair value of assets and liabilities	
Cash and cash equivalents	200
Trade payable and other payable	(200)
Accounts payable	<u>(3,068)</u>
Fair value of identifiable net assets	<u>(3,068)</u>
Goodwill	₩ 13,851

(c) The merger of Shinhan Life Insurance Co., Ltd. and Orange Life Insurance Co., Ltd.

Shinhan Life Insurance Co., Ltd. and Orange Life Insurance Co., Ltd. have merged on July 1, 2021 to form a holding company named Shinhan Life Insurance Co., Ltd. As a result of the merger, the common shareholders as of immediately prior to the merger of Orange Life Insurance Co., Ltd. (the extinct corporation) are entitled to receive 0.9226202 share of Shinhan Life Insurance Co., Ltd (the surviving corporation)'s common share (₩ 5,000 per share) per common share of Orange Life Insurance Co., Ltd. There is no further transfer of any such shares except in accordance with the exchange ratio agreed upon by both parties under the merger agreement addressed above.

(d) Subsidiary investment shares

On October 29, 2021, the Group signed a Share Purchase Agreement with BNP Paribas Group Co., Ltd. for a 94.54% (7,230,174 shares of common stock) stake in BNP Paribas Cardif Life Insurance Co., Ltd. At the end of the reporting period, the Financial Services Commission has yet approved the incorporation of subsidiary.

48. Events after reporting period

Subsidiaries of the Company, Shinhan Alternative Investment Management Inc. and Shinhan Asset Management Co., Ltd. has merged on January 5, 2022. After the merger, it has changed its name to Shinhan Asset Management Co., Ltd.

SHINHAN FINANCIAL GROUP CO., LTD. AND SUBSIDIARIES

Notes to the Consolidated Financial Statements

December 31, 2021 and 2020

(In millions of won)

49. Uncertainty due to changes in domestic and global economic conditions

The rapid spread of the COVID-19 is negatively affecting the global economy. The Group uses forward-looking information to estimate expected credit losses in accordance with K-IFRS No.1109 'Financial Instruments' and the default rate at the end of 2021 was re-estimated and reflected in the measurement of expected credit loss allowance using the changed forward-looking information on GDP growth and private consumption growth, which are major variables for calculating the default rate. As of December 31, 2021, the economic environment has remained uncertain. Expected credit losses may change depending on the end of the COVID-19 and the pace of economic recovery. The Group will continue to monitor the impact of the COVID-19 on the economy.

Risk exposures by major consolidated subsidiaries due to COVID-19 are as follows, figures may significantly vary for industries that are highly affected by future economic conditions:

(a) Shinhan Bank

		December 31, 2021							
		<u>Airlift passenger</u>	<u>Lodging</u>	<u>Oil/petroleum refinery</u>	<u>Art-related</u>	<u>Movie theater</u>	<u>Clothing manufacturing</u>	<u>Travel</u>	<u>Total</u>
Loans at amortized cost	₩	164,904	3,314,684	937,385	219,859	86,241	2,082,545	92,152	6,897,770
Securities at fair value through profit or loss		-	-	29,911	-	-	-	2,737	32,648
Securities at fair value through other comprehensive income		114,158	18,142	264,343	-	7,123	10,678	-	414,444
Off-balance accounts		364,351	323,638	2,650,311	20,196	91,622	982,026	37,941	4,470,085
	₩	<u>643,413</u>	<u>3,656,464</u>	<u>3,881,950</u>	<u>240,055</u>	<u>184,986</u>	<u>3,075,249</u>	<u>132,830</u>	<u>11,814,947</u>
		December 31, 2020							
		<u>Airlift passenger</u>	<u>Lodging</u>	<u>Oil/petroleum refinery</u>	<u>Art-related</u>	<u>Movie theater</u>	<u>Clothing manufacturing</u>	<u>Travel</u>	<u>Total</u>
Loans at amortized cost	₩	120,854	3,445,269	685,336	244,036	95,240	1,763,741	112,647	6,467,123
Securities at fair value through profit or loss		-	-	3,088	-	-	3,060	-	6,148
Securities at fair value through other comprehensive income		52,878	2,611	224,894	-	6,539	9,797	-	296,719
Off-balance accounts		404,767	289,948	3,058,516	9,630	111,266	938,705	60,171	4,873,003
	₩	<u>578,499</u>	<u>3,737,828</u>	<u>3,971,834</u>	<u>253,666</u>	<u>213,045</u>	<u>2,715,303</u>	<u>172,818</u>	<u>11,642,993</u>

SHINHAN FINANCIAL GROUP CO., LTD. AND SUBSIDIARIES

Notes to the Consolidated Financial Statements

December 31, 2021 and 2020

(In millions of won)

49. Uncertainty due to changes in domestic and global economic conditions (continued)

Risk exposures by major consolidated subsidiaries due to COVID-19 are as follows, figures may significantly vary for industries that are highly affected by future economic conditions (continued):

(b) Shinhan Card Co., Ltd.

December 31, 2021				
Retails				
	Credit sales	Short term card loan	Long term card loan	Total
Loans at amortized cost	₩ 371,197	152,838	387,318	911,353
Total Exposure	814,598		-	814,598
December 31, 2020				
Retails				
	Credit sales	Short term card loan	Long term card loan	Total
Loans at amortized cost	₩ 357,589	142,252	283,150	782,991
Total Exposure	702,124		-	702,124

SHINHAN FINANCIAL GROUP CO., LTD. AND SUBSIDIARIES

Notes to the Consolidated Financial Statements

December 31, 2021 and 2020

(In millions of won)

49. Uncertainty due to changes in domestic and global economic conditions (continued)

Risk exposures by major consolidated subsidiaries due to COVID-19 are as follows, figures may significantly vary for industries that are highly affected by future economic conditions (continued):

(c) Jeju Bank

		December 31, 2021								
		Airlift passenger	Lodging	Art-related	Movie theater	Leisure related service industry	Bus business	Bath business	Youth training facilities business	Total
Loans at amortized cost	₩	-	295,664	4,161	596	25,432	7,535	17,089	5,466	355,943
Off-balance accounts		4	5,439	161	4	991	197	538	6	7,340
	₩	<u>4</u>	<u>301,103</u>	<u>4,322</u>	<u>600</u>	<u>26,423</u>	<u>7,732</u>	<u>17,627</u>	<u>5,472</u>	<u>363,283</u>
		December 31, 2020								
		Lodging	Manufacturing	Retail	Construction Industry	Leisure related service industry	Transportation Business	Etc	Total	
Loans at amortized cost	₩	599,875	30,095	517,843	85,640	57,677	29,679	92,373	1,413,182	
Off-balance accounts		20,658	563	18,691	7,100	1,053	2,103	3,082	53,250	
	₩	<u>620,533</u>	<u>30,658</u>	<u>536,534</u>	<u>92,740</u>	<u>58,730</u>	<u>31,782</u>	<u>95,455</u>	<u>1,466,432</u>	

SHINHAN FINANCIAL GROUP CO., LTD. AND SUBSIDIARIES

Notes to the Consolidated Financial Statements

December 31, 2021 and 2020

(In millions of won)

49. Uncertainty due to changes in domestic and global economic conditions (continued)

As of December 31, 2021 and 2020, the exposure of the loans applied for moratorium of interest payments and moratorium of repayment in installments by Shinhan Bank is as follows:

(a) Shinhan Bank

	<u>December 31, 2021</u>	<u>December 31, 2020</u>
Moratorium of interest payments	₩ 224,449	242,794
Moratorium of repayment in installments	1,342,366	1,067,502
Moratorium of interest payments and moratorium of repayment in installments	<u>65,773</u>	<u>80,581</u>
	<u>₩ 1,632,588</u>	<u>1,390,877</u>

(b) Jeju Bank

	<u>December 31, 2021</u>	<u>December 31, 2020</u>
Moratorium of interest payments	₩ 348	629
Moratorium of repayment in installments	276,193	328,055
	<u>₩ 276,541</u>	<u>328,684</u>

